

General Catalog of Pneumatic/
Fluid Transport Tubing
**Tubing, Fitting
and CHEMIFIT™**



Common handling instructions for products in catalog

Safety Note

This Safety Note provides indications on the correct use of the product in order to prevent harm to people and property. The indications are classified into three categories, “danger”, “warning”, and “caution”, depending on the level of potential harm due to improper use. Each category contains important instructions on safety that should be followed in addition to the latest ISO 4414(*1), JIS B 8370(*2), ISO 4413 (*3), and JIS B 8361 (*4).

(*1) ISO 4414 Pneumatic fluid power...Recommendations for the application of equipment to transmission and control systems.

(*2) JIS B 8370 Pneumatic System General Rules

(*3) ISO 4413 Hydraulic fluid power...General rules for the application of equipment to transmission and control systems.

(*4) JIS B 8361 Hydraulic System General Rules

DANGER

Where inappropriate use of this equipment may cause death or severe injury and where immediate warning of a dangerous situation is mandated.

WARNING

Where inappropriate use of this equipment may cause death or severe injury.

CAUTION

Where inappropriate use of this equipment may cause minor injury.

For more safety information, please read the handling instructions carefully. A safety note for each product is also given on its product page and instruction page.

Exclusion of Liability

- ① Nitta Corporation is not liable for damage caused intentionally and unintentionally by customers, damage due to products other than Nitta's including software failure, and damage due to natural disasters.
- ② Nitta Corporation is not liable for damage due to usage that is not explained or specified in this catalog and instruction manual.
- ③ Nitta Corporation is not liable for damage without any clear record of its liability even if the damage occurred after the customer contacts Nitta.
- ④ Nitta Corporation is not liable for collateral damage such as loss of business income and business termination due to using Nitta's products or due to inability to use our products.

* Specifications in this catalog are subject to change without notice.

* Secondary use of information in this catalog for copy, distribution and sale without permission is prohibited.

INDEX

Common Handling Instructions

Index: Index of All Products **P.2**

Combination List of Tubing and Fitting (Working temperature range) **P.8**

Tubing Products **P.10**

Handling instructions INDEX

Tubing

Polyurethane tubing/Nylon tubing

Flexible fluorocarbon resin bilayer tubing/Flame-resistant tubing/Antistatic tubing

Shape-keeping tubing/Polybutene tubing

Clean tubing

Clean, Antistatic tubing/Polyolefin tubing/Fluorocarbon resin tubing

Processed tubing

Polyurethane coil tubing/Polyurethane multi-line tubing/Nylon coil tubing/Multi-pack tubing

Tubing Fitting Products **P.34**

Handling instructions INDEX

PushOne series

PushOne A series/PushOne A series(mini type)

PushOne E series/PushOne E series (brass body type)

QuickSeal series

Insertion type (brass)/Insertion type (stainless)/Insertless type

DK tubing dedicated type/Nylon coil tubing dedicated type

Chemifit series

Chemifit C1 series/Chemifit C1S series

Chemifit CSE series/Chemifit CP series

Bamboo-shoot series

Barb type

Control Switch and Detachable Products **P.134**

Handling instructions INDEX

Chemifit C1 speed controller/Compact speed controller/Speed controller

Ball valve/Throttle valve/Miniature valve

Valve built-in connector/Q.D.C 101 series/Q.D.C 103 series

Jigs, Tools and Accessories **P.158**

INDEX

Tube cutter/FW tubing outer cover peeling cutter/FWU tubing outer cover peeling cutter

Spatter cap/Off tool/Tube reel

Air balancer/Tool balancer

Technical Information **P.162**

INDEX

Speed controller flow characteristics/Effective sectional area/Negative-pressure performance list/Instruction manual

Reference **P.188**

INDEX

TES Tubing Technology Data/Applied standard list/Screw standard list/UL-94 standard flame test/Table of full scale tubing and screw/Unit conversion table/

Chemical resistance specification table/

Product Number Index **P.205**

Tubing

Clean tubing

Processed tubing

PushOne fitting

QuickSeal fitting

Clean fitting/Chemifit

Bamboo-shoot fitting

Control switch/Detachable series

Jig/Tool/Accessory

Technical information

Reference

INDEX

Tubing

Polyurethane Tubing

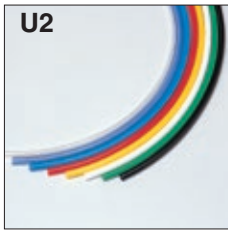

U2
For general air pressure
 ● Well balanced between flexibility and pressure-resistance performance

P.12

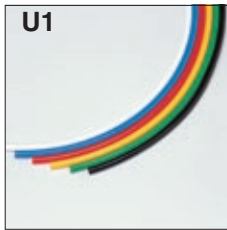

U1
For general air pressure
 ● Usable in higher air pressure range than U2

P.13

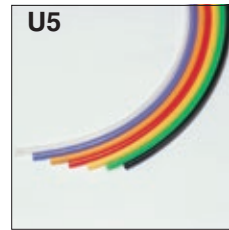

U5
For general air pressure (Ultra flexible)
 ● High workability with low bending stress

P.14

Nylon Tubing

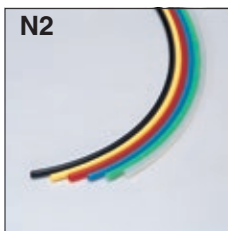

N2
For multi purpose piping
 ● High oil resistance and chemical resistance

P.15

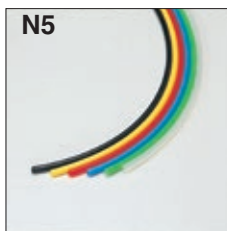

N5
Soft nylon
 ● High workability with low bending stress

P.16

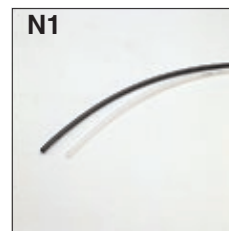

N1
Hard (unplasticized) nylon
 ● Unplasticized nylon

P.17

Flexible Fluorocarbon Resin Bilayer Tubing



TES
For coating (flexible)
 ● Bilayer structure of inner (special fluorocarbon resin) and outer (special nylon resin) layers
 ● High flexibility

P.18

Flame-resistant Tubing



FUK
For spot welding piping (flexible)
 ● High flame resistance (Compliant with V-0 of UL94 standard)
 ● Improves work efficiency with excellent flexibility, abrasion resistance, and sliding properties while requiring no peeling during pipe installation

P.19

Flame-resistant Tubing

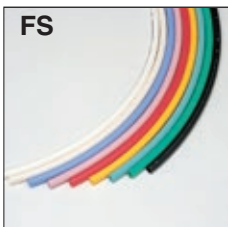

FS
For spot welding piping
 ● High flame resistance (Compliant with V-0 of UL94 standard)
 ● High flexibility

P.20

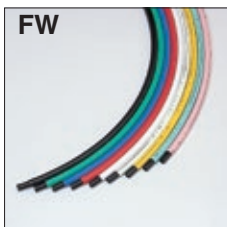

FW
For spot welding piping (bilayer)
 ● High flame resistance (Compliant with V-0 of UL94 standard)
 ● Bilayer structure with flame-resistant resin inner and outer layers

P.21

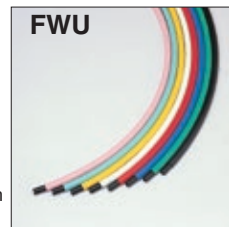

FWU
For spot welding piping (flexible)
 ● High flame resistance (Compliant with V-0 of UL94 standard)
 ● Bilayer structure with polyurethane tubing inner layer, high flexibility

P.22

Antistatic Tubing



UE
For general air pressure (electrically conductive)
 ● Conductive polyurethane elastomer for spark prevention

P.23

Shape-keeping Tubing



DK
For retaining shape
 ● Piping shape is kept
 ● Easy construction compared to copper

P.24

Polybutene Tubing

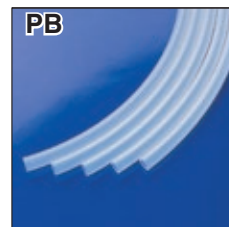

PB
For food processing machines
 ● Suitable for high temperature antimicrobial cleaning of food processing machines
 ● Compliant with the 370th notification of Ministry of Health and Welfare, Japan

P.24

Tubing

Clean tubing

Processed tubing

PushOne fitting

QuickSeal fitting

Clean fitting/ Chemifit

Bamboo-shoot fitting

Control switch/ Detachable series

Jig/Tool/ Accessory

Technical information

Reference

INDEX

Tubing

Clean tubing

Processed tubing

PushOne fitting

QuickSeal fitting

Clean fitting/
Chemifit

Bamboo-shoot fitting

Control switch/
Detachable series

Jig/Tool/
Accessory

Technical information

Reference

Clean Tubing

Clean, Antistatic Tubing

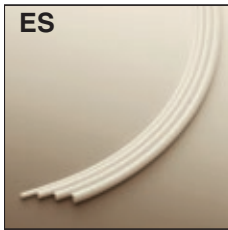

For clean piping

- Surface resistivity of $10^{11}\Omega/\text{sq}$ or lower
Does not allow dust to gather
- No contamination with particles
- Can be used with clean air and fluorine-based refrigerants

P.25

Polyolefin Resin Tubing

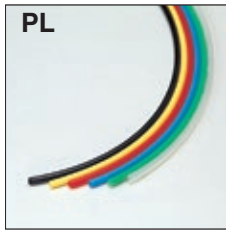

For clean piping

- Suitable for fluids such as clean air, N₂ gas, pure water and various chemical liquids
- Environment-friendly eco tubing
- Produced, end-sealed, heat-sealed for shipping in a cleanroom

P.26

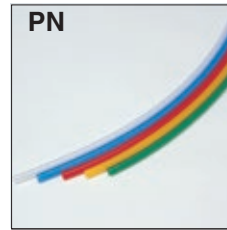

For clean piping (flexible)

- Suitable for fluids such as clean air, N₂ gas, pure water and various chemical liquids
- Environment-friendly eco tubing
- Produced, end-sealed, heat-sealed for shipping in a cleanroom
- High workability with low bending stress

P.27

Fluorocarbon Resin Tubing

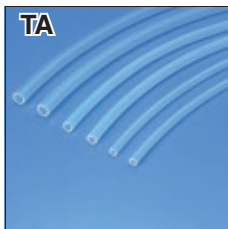

For clean, heat-resistant, cold-resistant, chemical-resistant use

- PFA resin tubing with high chemical resistance
- Produced, end-sealed, heat-sealed for shipping in a cleanroom

P.28

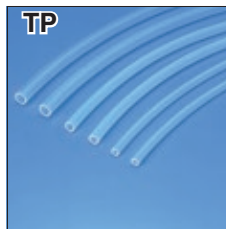

For clean, heat-resistant, cold-resistant, chemical-resistant use

- FEP resin tubing with high chemical resistance
- Produced, end-sealed, heat-sealed for shipping in a cleanroom

P.29

Processed Tubing

Polyurethane Coil Tubing

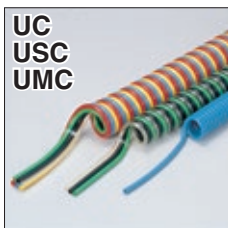

Polyurethane coil

- Coil tubing for general air pressure

P.30

Multi-line Tubing



Polyurethane multi-line

- Multi-core welding tubing for general air pressure

P.31

Nylon Coil Tubing



Nylon coil

- Single core nylon coil tubing with strong elasticity

P.32

Multi-pack Tubing



Bundled tubing

- Processed tubing for multi piping (Made to order)

P.33

INDEX

PushOne™ Series

PushOne™ A Series



For general air pressure

- PushOne connection
- High flame resistance (Compliant with V-0 of UL94 standard)
- Electroless nickel plated

P.36



Mini type

For general air pressure

- PushOne connection
- Compact
- Electroless nickel plated

P.50

PushOne™ E Series



For general air pressure

- PushOne connection
- Flame retardance (Compliant with V-0 of UL94 standard)
- Electroless nickel plated

P.56



Brass body type

For general air pressure

- PushOne connection
- Electrically conductive if combined with UE tubing
- High flame resistance (Compliant with V-0 of UL94 standard)

P.72

QuickSeal Series

QuickSeal Series

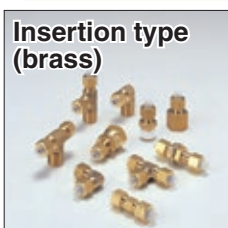

Insertion type (brass)

For multi-purpose piping

- Screw-in type
- High sealing performance
- Only connector is sealed

P.76



Insertion type (stainless)

For multi-purpose piping

- Screw-in type
- High sealing performance
- Made of SUS304

P.88



Insertless type

For general air pressure

- Screw-in type
- For large flow volume

P.94

QuickSeal Series

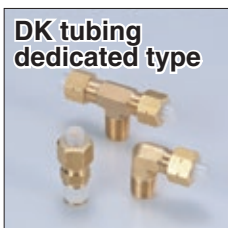

DK tubing dedicated type

For general air pressure

- Screw-in type

P.98



Nylon coil tubing dedicated type

For general air pressure

- Screw-in type

P.102

Tubing

Clean tubing

Processed tubing

PushOne fitting

QuickSeal fitting

Clean fitting/
Chemifit

Bamboo-shoot fitting

Control switch/
Detachable series

Jig/Tool/
Accessory

Technical information

Reference

INDEX

Chemifit™ Series

Chemifit™ C1 Series



For clean air, pure water, chemical liquid piping

- Made in oil-free process
- PushOne connection
- Nonmetal liquid-contact surface
- High performance, free of dust and contamination
- Double clean package

P.104

Chemifit™ C1S Series



For clean air, pure water, chemical liquid piping

- Made in oil-free process
- PushOne connection
- SUS304 screw
- Double clean package
- High performance, free of dust and contamination

P.112

Chemifit™ CSE Series



For clean air, pure water, chemical liquid piping

- Screw-in type fitting made of SUS316
- High workability of tubing with assembly nut
- Uniform workability for connecting tubing
- No rotation of tubing when tightening nut
- Made in oil-free process
- High sealing performance
- No need for additional tightening of assembly nut

P.118

Chemifit™ CP Series



For clean air, pure water, chemical liquid piping

- Threaded fitting made of polypropylene resin
- Made in oil-free process
- Highly smooth inner surface
- High performance, free of dust and contamination

P.126

Oil-free processing, clean wrapping and clean package

- Ultrasonic cleaning with no oil and fat used for assembling in a cleanroom.

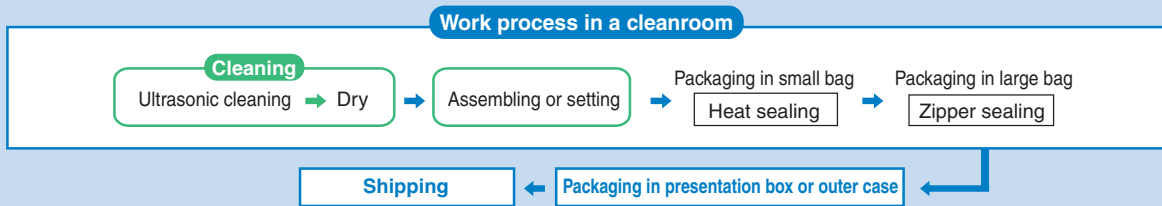

Bamboo-shoot Series

Bamboo-shoot Series



Barb type

Bamboo-shoot fitting

- Bamboo-shoot type
- Sealing-processed R thread
- Various shape combinations available

P.132

Tubing

Clean tubing

Processed tubing

PushOne fitting

QuickSeal fitting

Clean fitting/ Chemifit

Bamboo-shoot fitting

Control switch/ Detachable series

Jig/Tool/ Accessory

Technical information

Reference

INDEX

Control Switch and Detachable Series

Control Series

Chemifit™ C1 Speed Controller



- Suitable for environment (atmosphere) that requires chemical resistance
- PushOne connection
- Inline type (ESU) allows central control on piping line

P.136

Control Series

Compact Speed Controller



- Smaller than the conventional model
- PushOne connection
- Electroless nickel plated
- Sealing-processed R thread

P.138

Control Series

Speed Controller



- PushOne connection
- Inline type (ASU) allows central control on piping line
- Electroless nickel plated

P.140

Switch Series

Ball Valve



- Enables compact piping
- PushOne connection
- Position of handle can be changed
- Nickel plated

P.143

Control Series

Throttle Valve



- Fine control of flow rate
- Inline type (ANU) allows central control on piping line
- PushOne connection
- Electroless nickel plated

P.146

Miniature Valve



- Easy flow rate control
- PushOne connection for millimeter size type (quick seal type for inch size type)

P.148

Detachable Series

Valve Built-in Connector

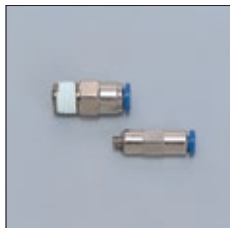

- Opening/Closing inside valve by detaching tubing
- PushOne connection
- Electroless nickel plated

P.151

Detachable Series

Q.D.C 101



Compact coupler for air pressure

- Push-To-Connect type
- Automatic opening/closing valve inside the coupler
- PushOne fitting integrated types available

P.152

Q.D.C 103



Micro coupler for air and oil pressure

- Push-To-Connect type
- Automatic opening/closing valve inside the coupler
- Smaller than 101 series
- Electroless nickel plated

P.155

Tubing

Clean tubing

Processed tubing

PushOne fitting

QuickSeal fitting

Clean fitting/Chemifit

Bamboo-shoot fitting

Control switch/Detachable series

Jig/Tool/Accessory

Technical information

Reference

INDEX

Jigs, Tools and Accessories

Tube Cutter



TC04

- Compact, handy-to-carry, lightweight tube cutter
- The blade is replaceable. It comes with three spare blades
- Can cut tubes of up to 16mm diameter

P.159



TC01

- Highly durable nipper-type tube cutter
- Can cut tubes of up to 13mm diameter

P.159

Hose Cutter



HC03

- Highly durable nipper-type tube cutter
- Can cut tubes of up to 20mm diameter

P.159

FW/FWU Tubing Outer Cover Peeling Cutter



TC02
TC03

- Easy peeling of FW tubing outer cover

P.160



TC02U
TC03U

- Easy peeling of FWU tubing outer cover

P.160

Spatter Cap



CP•CPFW•CPP

- Protects PushOne connecting part from spatter (hot wasted metal), etc
- CCP can be attached after connecting tubing

P.161

Off Tool



EOT

- Easy removal of PushOne fitting from tubing

P.161

Tube Reel

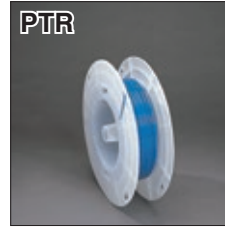

PTR

- Easy handling
- Recycled polypropylene resin used

P.161

Tubing

Clean tubing

Processed tubing

PushOne fitting

QuickSeal fitting

Clean fitting/
Chemifit

Bamboo-shoot fitting

Control switch/
Detachable series







Jig/Tool/
Accessory

Technical information











Reference

Combination List of Tubing and Fitting (Working temperature range)

- See “Chemical resistance specification table” at the end of this catalog if a chemical is contained in fluid or atmosphere. Proper usage should be judged based on your use condition data.
- Before using the tubing and fitting in combination, read the handling instructions of each product carefully.

Tubing type	Fitting type	Series	PushOne series				QuickSeal series					Bamboo-shoot series		
		Product	A series		E series		Insertion type (brass)		Insertion type (SUS304)	Insertless type	DK fittings	Nylon coil fittings	Barb type	
				mini type		Brass body type								
		Fluid												
Tubing	Polyurethane tubing	U2	Air	-20~+80	-20~+80	-20~+80	-20~+80	-40~+80		-40~+80				
			Water	0~+40		0~+40		0~+50		0~+50				
		U1	Air	-20~+80	-20~+80	-20~+80	-20~+80	-40~+80		-40~+80				
	Water		0~+40		0~+40		0~+50		0~+50					
	Nylon tubing	N5	Air	-20~+80	-20~+80	-20~+80	-20~+80	-40~+80	-40~+100	-40~+80	-40~+100			
			Water	0~+40		0~+40		0~+50		0~+50				
			General operating oil					-40~+80	-40~+100	-40~+80				
		N2	Air	-20~+80	-20~+80	-20~+80	-20~+80	-40~+80	-40~+100	-40~+80	-40~+100			
			Water	0~+40		0~+40		0~+70		0~+70				
			General operating oil					-40~+80	-40~+100	-40~+80				
		N1	Air	-20~+80	-20~+80	-20~+80	-20~+80	-40~+80	-40~+100	-40~+80	-40~+100			
			Water	0~+40		0~+40		0~+70		0~+70				
			General operating oil					-40~+80	-40~+100	-40~+80				
		Flexible fluorocarbon resin tubing	TES	Air					-40~+80		-40~+80			
				Water					0~+70		0~+70			
				Water-based paint (*4)					0~+40		0~+40			
	Shape-keeping tubing	DK	Air								-40~+60			
	Polybutene tubing	PB	Air					-10~+80	-10~+90	-10~+80				
			Water					0~+70	0~+90	0~+70				
	Flame-resistant tubing	FUK	Air	-20~+80		-20~+80	-20~+80		-40~+80(*1)	-40~+80				
Water			0~+40		0~+40			0~+60(*1)	0~+60					
FS		Air	-20~+80		-20~+80	-20~+80		-40~+100(*1)	-40~+80					
		Water	0~+40		0~+40			0~+70(*1)	0~+70					
FW		Air	-20~+80		-20~+80	-20~+80		-40~+80(*1)	-40~+80					
		Water	0~+40		0~+40			-0~+70(*1)	0~+70					
FWU	Air	-20~+80		-20~+80	-20~+80		-40~+80(*1)	-40~+80						
	Water	0~+40		0~+40			-0~+50(*1)	0~+50						
Antistatic tubing	UE	Air	-20~+80(*3)	-20~+80(*3)	-20~+80(*3)	-20~+80(*3)	-40~+80		-40~+80					
		ES	Air (Clean air)						-40~+80(*2)					
Clean tubing	Polyolefin resin tubing	PL	Air (Clean air)	-20~+80(*2)	-20~+80(*2)	-20~+80(*2)		-40~+80(*2)		-40~+80(*2)				
			Water (pure water)	0~+40(*2)		0~+40(*2)		0~+70(*2)		0~+70(*2)				
		PN	Air (Clean air)	-20~+80(*2)	-20~+80(*2)	-20~+80(*2)		-40~+80(*2)		-40~+80(*2)				
			Water (pure water)	0~+40(*2)		0~+40(*2)		0~+70(*2)	0~+80(*2)	0~+70(*2)				
Fluorocarbon resin tubing	TA	Air (Clean air)	-20~+80(*2)	-20~+80(*2)	-20~+80(*2)	-20~+80(*2)	-40~+80(*2)	-40~+100(*2)	-40~+80(*2)					
		Water (pure water)	0~+40(*2)		0~+40(*2)		0~+70(*2)	0~+100(*2)	0~+70(*2)					
	TP	Air (Clean air)	-20~+80(*2)	-20~+80(*2)	-20~+80(*2)	-20~+80(*2)	-40~+80(*2)		-40~+80(*2)					
		Water (pure water)	0~+40(*2)		0~+40(*2)		0~+70(*2)		0~+70(*2)					
Processed tubing	Polyurethane processed tubing	UC	Air				-40~+80		-40~+80					
		USC	Air				-40~+80		-40~+80					
		UMC	Air				-40~+80		-40~+80					
		UML	Air				-40~+80		-40~+80					
	Nylon coil tubing	S	Air								-40~+100			

(*1) If spatter (hot wasted metal) is likely to cling to the connection part of tubing, use a brass tubing instead of a nylon one.
 (*2) This is a combination of clean and general types.
 When using them together in a clean environment, be aware of how this could lower the clearliness level.
 (*3) Use a brass body type of connector and internal connector to keep fittings and the tubing electrically conductive.
 (*4) Use water-based paint, or aliphatic or aromatic carbon hydride solvent. Contact us for other types of fluid.

Clean fitting, Chemifit series				Control switch, detachable series							Series		Fitting type
C1 series	C1S series	CSE series	CP series	Compact speed controller	Chemifit C1 speed controller	Speed controller	Ball valve	Throttle valve	Miniature valve		Product	Fluid	
													
-20~+80(*2)	-20~+80(*2)	-40~+80(*2)		+5~+60	+5~+60	+5~+60	-20~+80	-20~+80	-20~+80	-20~+80	Air	U2	
0~+50(*2)	0~+50(*2)	0~+50(*2)					0~+40	0~+40	0~+40	0~+40	Water		
-20~+80(*2)	-20~+80(*2)	-40~+80(*2)		+5~+60	+5~+60	+5~+60	-20~+80	-20~+80	-20~+80	-20~+80	Air	U1	
0~+50(*2)	0~+50(*2)	0~+50(*2)					0~+40	0~+40	0~+40	0~+40	Water		
		-40~+60(*2)				+5~+60	-20~+80	-20~+80	-20~+80	-20~+80	Air	U5	
				+5~+60		+5~+60	-20~+80	-20~+80	-20~+80	-20~+80	Air	N5	
							0~+40	0~+40	0~+40	0~+40	Water		
											General operating oil		
				+5~+60		+5~+60	-20~+80	-20~+80	-20~+80	-20~+80	Air	N2	
							0~+40	0~+40	0~+40	0~+40	Water		
											General operating oil		
				+5~+60		+5~+60	-20~+80	-20~+80	-20~+80	-20~+80	Air	N1	
							0~+40	0~+40	0~+40	0~+40	Water		
											General operating oil		
		-40~+100(*2)									Air	TES	
		0~+70(*2)									Water		
		0~+40(*2)									Water-based paint (-4)		
											Air	DK	
		-10~+90(*2)									Air	PB	
		0~+90(*2)								-10~+80	Water		
		-40~+80(*2)		+5~+60		+5~+60	-20~+80	-20~+80	-20~+80	-20~+80	Air	FUK	
		0~+60(*2)					0~+40	0~+40	0~+40	0~+40	Water		
				+5~+60		+5~+60	-20~+80	-20~+80	-20~+80	-20~+80	Air	FS	
							0~+40	0~+40	0~+40	0~+40	Water		
				+5~+60		+5~+60	-20~+80	-20~+80	-20~+80	-20~+80	Air	FW	
							0~+40	0~+40	0~+40	0~+40	Water		
				+5~+60		+5~+60	-20~+80	-20~+80	-20~+80	-20~+80	Air	FWU	
							0~+40	0~+40	0~+40	0~+40	Water		
		-40~+60(*2)									Air	UE	
		-50~+80									Air (Clean air)	ES	
		-50~+50									Fluorine-based inert fluid		
-20~+80	-20~+80	-60~+80	-20~+80	+5~+60(*2)	+5~+60	+5~+60(*2)	-20~+80(*2)	-20~+80(*2)	-20~+80(*2)	-20~+80(*2)	Air (Clean air)	PL	
0~+80	0~+80	0~+80	0~+80				-0~+40(*2)	-0~+40(*2)	-0~+40(*2)	-0~+40(*2)	Water (pure water)		
-20~+80	-20~+80	-60~+80		+5~+60(*2)	+5~+60	+5~+60(*2)	-20~+80(*2)	-20~+80(*2)	-20~+80(*2)	-20~+80(*2)	Air (Clean air)	PN	
0~+80	0~+80	0~+80					-0~+40(*2)	-0~+40(*2)	-0~+40(*2)	-0~+40(*2)	Water (pure water)		
-20~+80	-20~+80	-65~+260	-20~+80	+5~+60(*2)	+5~+60	+5~+60(*2)	-20~+80(*2)	-20~+80(*2)	-20~+80(*2)	-20~+80(*2)	Air (Clean air)	TA	
0~+80	0~+80	0~+100					-0~+40(*2)	-0~+40(*2)	-0~+40(*2)	-0~+40(*2)	Water (pure water)		
-20~+80	-20~+80		-20~+80	+5~+60(*2)	+5~+60	+5~+60(*2)	-20~+80(*2)	-20~+80(*2)	-20~+80(*2)	-20~+80(*2)	Air (Clean air)	TP	
0~+80	0~+80		0~+80				-0~+40(*2)	-0~+40(*2)	-0~+40(*2)	-0~+40(*2)	Water (pure water)		
		-40~+80(*2)									Air	UC	
		-40~+80(*2)									Air	USC	
		-40~+80(*2)									Air	UMC	
		-40~+80(*2)									Air	UML	
											Air	S	

Tubing

Tubing

Handling instructions for tubing products

⚠ Safety Note

This Safety Note provides indications on the correct use of the product in order to prevent harm to people and property. The indications are classified into three categories, "danger", "warning", and "caution", depending on the level of potential harm due to improper use. Each category contains important instructions on safety that should be followed in addition to the latest ISO 4414(*1), JIS B 8370(*2), ISO 4413(*3), and JIS B 8361(*4).

(*1) ISO 4414 Pneumatic fluid power...Recommendations for the application of equipment to transmission and control systems.

(*2) JIS B 8370 Pneumatic System General Rules

(*3) ISO 4413 Hydraulic fluid power...General rules for the application of equipment to transmission and control systems.

(*4) JIS B 8361 Hydraulic System General Rules

⚠ DANGER

Where inappropriate use of this equipment may cause death or severe injury and where immediate warning of a dangerous situation is mandated.

⚠ WARNING

Where inappropriate use of this equipment may cause death or severe injury.

⚠ CAUTION

Where inappropriate use of this equipment may cause minor injury.

⚠ Before Selection

⚠ DANGER

- Cannot use for machines or equipment for life support.
- To use for machines or equipment that require extremely high safety, measures have to be taken to prevent danger with in the event tubes pulls out, bursts or leaks.

⚠ WARNING

- Please contact us before using our products under conditions other than those specified in the catalog.
- Please contact us before using our products for equipment, machines, various types of vehicles, and passenger aircraft, for leisure equipment passenger transport, for medical equipment that would cause human harm in case the specifications are not properly followed, and for machines in contact with food or drinking water.

⚠ Selection

⚠ WARNING

- Please check that our products are used under the "use conditions" specified in the catalog.
- Do not use our products when a caustic or flammable gas is used as the fluid or is in the environment.

⚠ CAUTION

- Do not use our products in places where excessive vibration or impact may occur.
- If use conditions differ between the tubing and the fitting, use them under the lower specified conditions.
- For Nitta's tubing products, use fitting products that Nitta specifies or JIS B 8381-1995 on-spec products.
- When water is used as the operating fluid, the tubing material might degrade depending on the additive. Contact us for details.
- The ultraviolet rays in direct sunlight and fluorescent light could enhance degradation and shorten the life of the tubing.
- When a chemical is used in fluid or the environment, see "Chemical resistance specification table".
- When spatter (hot wasted metal) is likely to stick to the tubing, use flame-resistant products only. Otherwise the spatter may cause a fire.
- The maximum working pressure of a tubing varies with working temperature. See "Relation between the working temperature and the maximum working pressure."

⚠ Installation

⚠ WARNING

- Fix tubes in place when installing them in a situation where unexpected disconnection of the tubing and connector could cause harm to people or property.

⚠ CAUTION

- Instructions for connecting tubes are provided in a separate document. Please read it and follow the installation instructions.
- Nitta only guarantees products fabricated by designated companies.
- Prevent damage to tubes, e.g. entanglement or abrasion. It could cause flattening, destruction, and disconnection.
- Install tubes so as to prevent loads such as tension, torsion, rotation, and bending with a radius smaller than the minimum bending radius.
- Do not bend a tubing, which might cause "fatigue destruction" at the break point even below the maximum working pressure.
- When the connection part of a tubing is dirty, clean the surface.
- Do not use tubes if they are dented or damaged.
- Check for any changes in the outer and inner diameters of tubes due to inner pressure or heat before you re-connect them to fittings. Replace any tubes that are affected.

⚠ Usage

⚠ WARNING

- Nitta's products should be handled only by designers who have sufficient knowledge of equipment, instruments and systems in which our products are to be installed, or by persons responsible for determining specifications. Test and analysis should be conducted if necessary. The designers or the responsible persons are liable for the performance and the safety of the equipment, instruments and systems.

⚠ CAUTION

- When water is used as fluid, do not allow it to freeze.
- Do not touch a tubing at pressurization. Improperly treating or touching a tubing at pressurization may lead to danger from unexpected breakage or leakage of fluid.
- Do not touch a tubing when the operating fluid is hot. Doing so may cause burns.

⚠ Storage

⚠ CAUTION

- When storing unused products, make sure to keep them in a clean place to prevent dust. When fine particles such as dust enter the inside of tubing products or the connected equipment, they may cause problems.
- Keep products in a dry place below 40°C avoiding direct sunlight. In particular, if nylon tubes and flame-resistant tubes are stored for a long period in a high-temperature high-humidity environment, white powder extract sometimes appears through the plasticizer on their surface, although it does not affect tubing performance.
- Do not use tubing products that have been stored for more than one year after production.
- The packaging of clean tubes should be opened just before use. Store the tubes in a box in a clean place in a dust-free environment.

⚠ Maintenance and Inspection

⚠ CAUTION

- Before handling or removing Nitta's products, be sure to check the safety by shutting off the power supply, stopping the pressure supply, evacuating pressurized air in the pipe, and terminating the operation of equipment, instruments, and systems.
- Please be sure to make periodic inspections. Confirm that there is no degradation such as outer damage, corrosion, and abrasion and replace any damaged piping.

⚠ Disposal

⚠ CAUTION

- Dispose of unnecessary products as industrial waste or have them disposed of by a waste disposal firm. In particular, incineration of products containing fluorocarbon may generate a toxic pyrolysis gas.

Tubing INDEX

Tubing

Clean tubing

Processed tubing

PushOne fitting

QuickSeal fitting

Clean fitting/Chemifit

Bamboo-shoot fitting

Control switch/Detachable series

Jig/Tool/Accessory

Technical information

Reference

Polyurethane Tubing

For general air pressure



For general air pressure (high pressure type)



For general air pressure (ultra flexible)



Nylon Tubing

For multi purpose piping



Soft nylon



Hard (unplasticized) nylon



Flexible Fluorocarbon Resin Bilayer Tubing

For coating (flexible and abrasion resistant)



Flame-resistant Tubing

For spot welding piping (flexible)



For spot welding piping



For spot welding piping (bilayer)



For spot welding piping (flexible)



Antistatic Tubing

For general air pressure (electrically conductive)



For retaining shape Tubing

Shape keeping



Polybutene Tubing

For food processing machines



Clean, Antistatic Tubing

Prevention of dielectric breakdown



Polyolefin Resin Tubing

For clean piping (flexible)



For clean piping (flexible)



Fluorocarbon Resin Tubing

For clean, heat-resistant, cold-resistant, chemical-resistant use

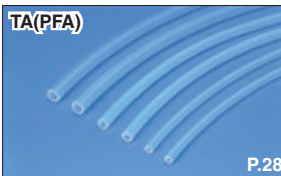

For clean, heat-resistant, cold-resistant, chemical-resistant use

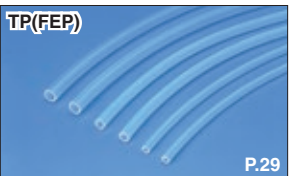

Polyurethane Coil Tubing

Polyurethane coil



Multi-line Tubing

Polyurethane multi-line tubing



Nylon Coil Tubing

Nylon coil



Multi-pack Tubing

Bundled



Polyurethane Tubing

U2

For general air pressure

Features

- Well balanced between flexibility and pressure-resistant performance, and high workability. Most suitable for general air pressure piping usage.
- Ether polyurethane resin is used to prevent degradation by water or mold under high temperature and high humidity.
- Coil processing and welding can be performed on request.



Product number table

● Millimeter size type (Group 4)

Type	Outer diameter × Inner diameter (mm)	Max. working pressure (MPa at 20°C)	Min. bending radius (mm)	Weight (g/m)	Standard color (color symbol)								
					Black	White	Yellow	Blue	Green	Red	Clear	Clear blue	
					BK	WH	YL	BU	GN	RE	CL	CBU	
U2-4-3×2	3×2	(Air) 0.8	10	5	●	—	—	—	—	—	—	—	—
U2-4-4×2.5	4×2.5		10	9	●	○	●	●	●	●	○	○	
U2-4-6×4	6×4		15	19	●	○	●	●	●	●	○	○	
U2-4-8×5	8×5	(Water) 0.6	23	35	●	○	●	●	●	●	○	○	
U2-4-10×6.5	10×6.5		30	52	●	○	●	●	●	●	○	○	
U2-4-12×8	12×8		35	72	●	○	●	●	●	●	○	○	
U2-4-16×12	16×12		50	103	●	—	—	—	—	—	—	—	

● Inch size type (Group 1)

Type	Outer diameter × Inner diameter (mm)	Max. working pressure (MPa at 20°C)	Min. bending radius (mm)	Weight (g/m)	Standard color (color symbol)					
					Black	Yellow	Blue	Green	Red	Clear
					BK	YL	BU	GN	RE	CL
U2-1-3/16	4.76×3.48	(Air) 0.6	13	10	●	●	●	●	●	○
U2-1-1/4	6.35×4.57		20	18	●	●	●	●	●	○
U2-1-5/16	7.94×5.90		27	26	●	●	●	●	●	○
U2-1-3/8	9.53×6.99	(Water) 0.4	28	39	●	●	●	●	●	○
U2-1-1/2	12.70×9.56		35	65	●	●	●	●	●	○

Standard length

20M, 100M ☞ U2-4-16×12: 50M only

Product number example

U2 - 4 - 6x4 - BK - 100M

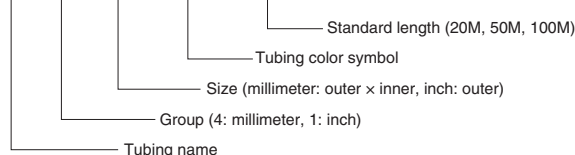

Operating fluid, working temperature range

Operating fluid	Working temperature range
Air	-40°C~+80°C
Water	0°C~+50°C

Negative pressure performance

-101.294kPa

Relation between the working temperature and the maximum working pressure

The maximum working pressure varies with the working temperature (environmental temperature). For use at an abnormal temperature, always check the maximum working pressure change in the graph below and keep the pressure within the indicated range.

⚠ Caution: Using tubes at a pressure outside the range may cause accidents or damage, for which Nitta is not liable.

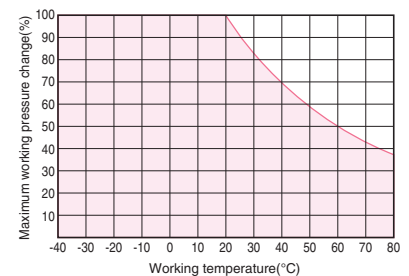

Handling instructions

⚠ Caution: When water is used as the operating fluid, the tubing material might degrade depending on the additive. Contact us for details.

⚠ Caution: When water is used as the operating fluid, keep the surge pressure below the maximum working pressure. Also, do not allow the water to freeze.

☞ See page 10 for common instructions for tubing products.

Applicable fittings

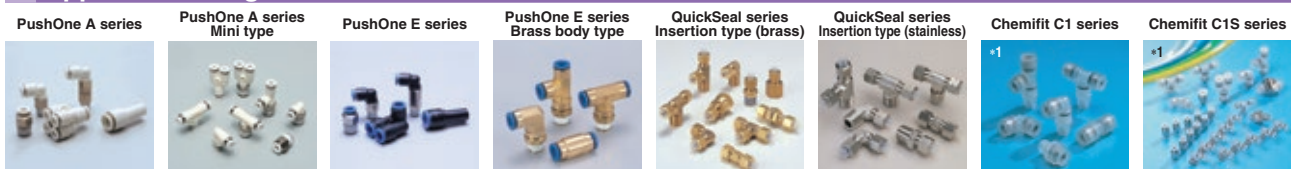

Applicable fittings



Related products and product introduction

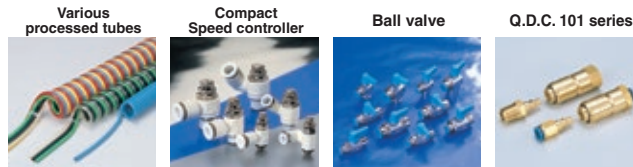

Reference

Chemical resistance specification tableP.198
Effective sectional area ...P.168
Negative-pressure performance listP.169

(*1) Combinatory use of U2 tubing and Chemifit series mixes general and clean type performances. When using them together in a clean environment, be aware of how this could lower the cleanliness level.

Polyurethane Tubing

U1

For general air pressure (high pressure type)

Features

- Usable in higher air-pressure range than U2 tubing.
- Ether polyurethane resin is used to prevent degradation by water or mold under high temperature and high humidity.
- Coil processing and welding can be performed on request.

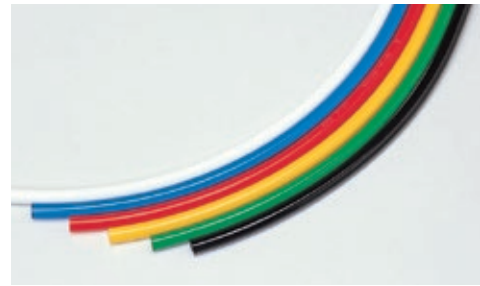

Product number table

● Millimeter size type (Group 4)

Type	Outer diameter × Inner diameter (mm)	Max. working pressure (MPa at 20°C)	Min. bending radius (mm)	Weight (g/m)	Standard color (color symbol)					
					Black	White	Yellow	Blue	Green	Red
					BK	WH	YL	BU	GN	RE
U1-4-4×2.5	4×2.5	(Air) 1.2	10	9	●	○	●	●	●	●
U1-4-6×4	6×4		15	19	●	○	●	●	●	●
U1-4-8×5	8×5		23	36	●	○	●	●	●	●
U1-4-10×6.5	10×6.5	(Water) 0.9	30	53	●	—	—	—	—	—
U1-4-12×8	12×8		35	73	●	—	—	—	—	—

Standard length

20M, 100M

Product number example

U1 - 4 - 6x4 - BK - 100M

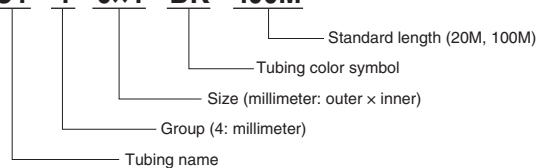

Operating fluid, working temperature range

Operating fluid	Working temperature range
Air	-40°C~+80°C
Water	0°C~+50°C

Negative pressure performance

-101.294kPa

Relation between the working temperature and the maximum working pressure

The maximum working pressure varies with the working temperature (environmental temperature). For use at an abnormal temperature, always check the maximum working pressure change in the graph below and keep the pressure within the indicated range.

⚠ Caution: Using tubes at a pressure outside the range may cause accidents or damage, for which Nitta is not liable.

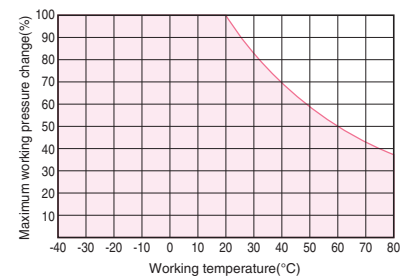

Handling instructions

⚠ Caution: When water is used as the operating fluid, the tubing material might degrade depending on the additive. Contact us for details.

⚠ Caution: When water is used as the operating fluid, keep the surge pressure below the maximum working pressure. Also, do not allow the water to freeze.

📖 See page 10 for common instructions for tubing products.

Applicable fittings

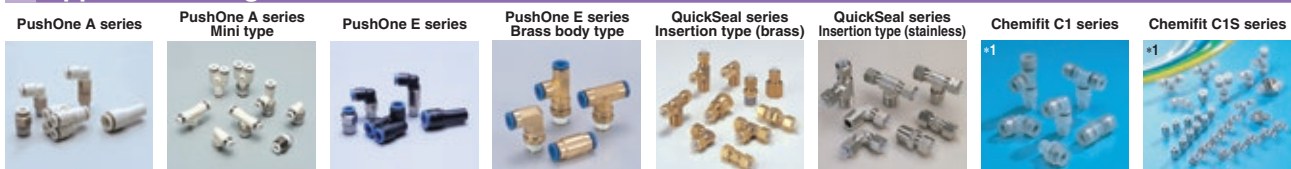

Applicable fittings

Chemifit CSE series



Related products and product introduction

Compact Speed controller



Ball valve



Q.D.C. 101 series



Reference

Chemical resistance specification tableP.198
Effective sectional area ...P.168
Negative-pressure performance listP.169

(*1) Combinatory use of U1 tubing and Chemifit series mixes general and clean type performances. When using them together in a clean environment, be aware of how this could lower the cleanliness level.

Polyurethane Tubing

U5

For general air pressure (ultra flexible)

Features

- The lowest bending stress among polyurethane tubes ensures high workability.
- Ether polyurethane resin is used to prevent degradation by water or mold under high temperature and high humidity.
- Usable for barb fittings (bamboo-shoot fittings).

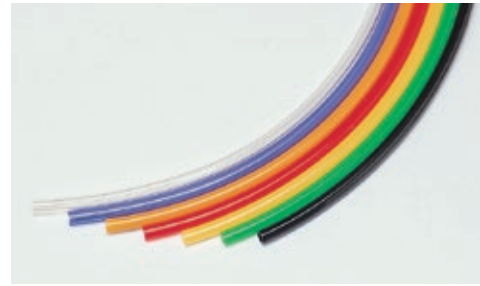

Product number table

● Millimeter size type (Group 4)

Type	Outer diameter × Inner diameter (mm)	Max. working pressure (MPa at 20°C)	Min. bending radius (mm)	Weight (g/m)	Standard color (color symbol)						
					Black	Yellow brown	Clear	Clear blue	Clear green	Clear red	Clear yellow
					BK	BYL	CL	CBU	CGN	CRE	CYL
U5-4-3.5×2	3.5×2	0.4	7	8	●	●	○	○	○	○	○
U5-4-4×2.5	4×2.5		10	9	●	●	○	○	○	○	○
U5-4-6×4	6×4		15	19	●	●	○	○	○	○	○

Standard length

20M, 100M

Product number example

U5 - 4 - 6×4 - BK - 100M

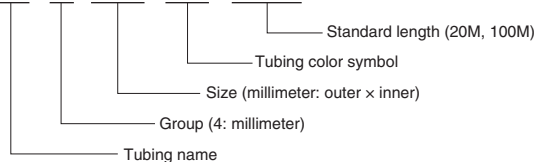

Operating fluid, working temperature range

Operating fluid	Working temperature range
Air	-40°C~+80°C

Negative pressure performance

-101.294kPa

Relation between the working temperature and the maximum working pressure

The maximum working pressure varies with the working temperature (environmental temperature). For use at an abnormal temperature, always check the maximum working pressure change in the graph below and keep the pressure within the indicated range.

⚠ Caution: Using tubes at a pressure outside the range may cause accidents or damage, for which Nitta is not liable.

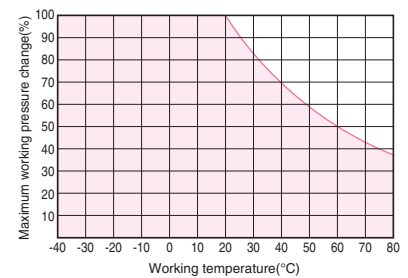

Handling instructions

⚠ Caution: Water should not be used for operating fluid because of possible hydrolysis.

📖 See page 10 for common instructions for tubing products.

Applicable fittings



(*1) Combinatory use of U5 tubing and Chemifit series mixes general and clean type performances. When using them together in a clean environment, be aware of how this could lower the cleanliness level.

Related products and product introduction

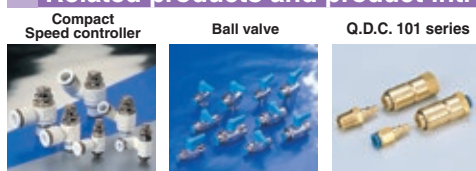

Reference

Chemical resistance specification tableP.198
Effective sectional area ...P.168
Negative-pressure performance listP.169

Nylon Tubing

N2

For multi-purpose piping

Features

- High oil resistance and chemical resistance.
- Group 2 type endures up to 4.8MPa (at 20°C).
- High abrasion resistance.

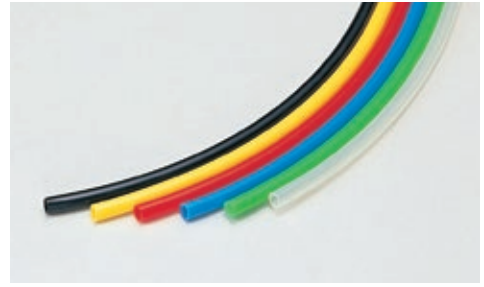

Product number table

● Millimeter size type (Group 4)

Type	Outer diameter x Inner diameter (mm)	Max. working pressure (MPa at 20°C)	Min. bending radius (mm)	Weight (g/m)	Standard color (color symbol)					
					Black	Milky white	Yellow	Blue	Green	Red
					BK	MW	YL	BU	GN	RE
N2-4-4x2	4x2	5.0	10	11	●	○	—	—	—	—
N2-4-4x2.5	4x2.5	3.3	15	8	●	○	●	●	●	●
N2-4-4x3	4x3	2.0	20	6	●	○	—	—	—	—
N2-4-6x4	6x4	3.0		17	●	○	●	●	●	●
N2-4-6x4.5	6x4.5	2.0	35	13	●	○	●	●	●	●
N2-4-8x6	8x6			23	●	○	●	●	●	●
N2-4-10x7.5	10x7.5	1.6	45	35	●	○	—	—	—	—
N2-4-10x8	10x8			29	●	○	●	●	●	●
N2-4-12x9	12x9	2.0	100	51	●	○	●	●	●	●
N2-4-16x13	16x13	1.6		70	●	○	—	—	—	—

● Inch size type (Group 1)

Type	Outer diameter x Inner diameter (mm)	Max. working pressure (MPa at 20°C)	Min. bending radius (mm)	Weight (g/m)	Standard color (color symbol)					
					Black	Milky white	Yellow	Blue	Green	Red
					BK	MW	YL	BU	GN	RE
N2-1-1/8	3.18x2.25	2.3	13	4	●	○	—	—	—	—
N2-1-3/16	4.76x3.48		16	9	●	○	●	●	●	●
N2-1-1/4	6.35x4.57		23	16	●	○	●	●	●	●
N2-1-5/16	7.94x5.90		29	23	●	○	●	●	●	●
N2-1-3/8	9.53x6.99		35	35	●	○	●	●	●	●
N2-1-1/2	12.70x9.56		45	58	●	○	●	●	●	●
N2-1-5/8	15.88x11.10		140	107	●	○	—	—	—	—

● Inch size type (Group 2) –High pressure type–

Type	Outer diameter x Inner diameter (mm)	Max. working pressure (MPa at 20°C)	Min. bending radius (mm)	Weight (g/m)	Standard color (color symbol)	
					Black	Milkywhite
					BK	MW
N2-2-1/8	3.18x1.60	4.8	7	6	●	○
N2-2-3/16	4.76x2.42		12	14	●	○
N2-2-1/4	6.35x3.21		13	25	●	○
N2-2-5/16	7.94x4.02		19	39	●	○
N2-2-3/8	9.53x4.81		26	56	●	○
N2-2-1/2	12.70x6.40		99	99	●	○

☞ Use fittings of insertion type (Group 2) in QuickSeal series.

Standard length

20M, 100M

Product number example

N2 - 4 - 6x4 - BK - 100M

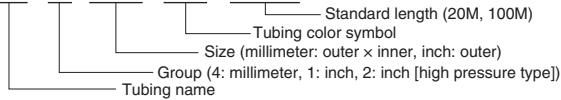

Operating fluid, working temperature range

Operating fluid	Working temperature range
Air	-40°C~+100°C
Water	0°C~+70°C
General operating oil	-40°C~+100°C

☞ Contact us for other operating fluids.

Negative pressure performance

-101.294kPa

Relation between the working temperature and the maximum working pressure

The maximum working pressure varies with the working temperature (environmental temperature). For use at an abnormal temperature, always check the maximum working pressure change in the graph below and keep the pressure within the indicated range.

⚠ Caution: Using tubes at a pressure outside the range may cause accidents or damage, for which Niitta is not liable.

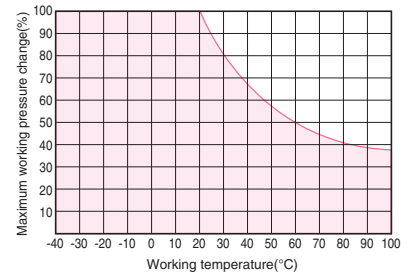

Handling instructions

⚠ Caution: When water is used as the operating fluid, the tubing material might degrade depending on the additive. Contact us for details.

⚠ Caution: When water is used as the operating fluid, keep the surge pressure below the maximum working pressure. Also, do not allow the water to freeze.

☞ See page 10 for common instructions for tubing products.

Applicable fittings



Related products and product introduction

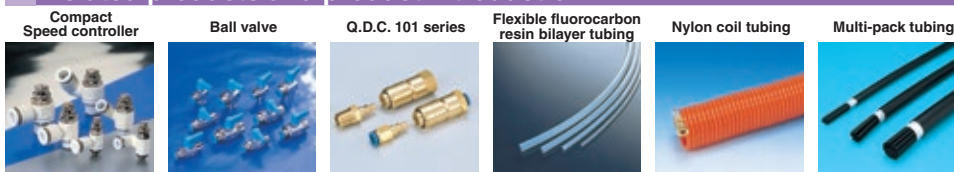

Reference

Chemical resistance specification tableP.198
Effective sectional area ...P.168
Negative-pressure performance listP.169

Tubing

Clean tubing

Processed tubing

PushOne fitting

QuickSeal fitting

Clean fitting/Chemi-fit

Bamboo-shoot fitting

Control switch/Detachable series

Jig/Tool/Accessory

Technical information

Reference

Nylon Tubing

N5

Soft nylon

Features

- Most flexible nylon tubing.
- High abrasion resistance.
- High oil resistance and chemical resistance.

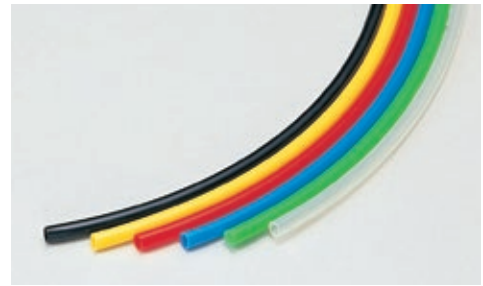

Product number table

● Millimeter size type (Group 4)

Type	Outer diameter × Inner diameter (mm)	Max. working pressure (MPa at 20°C)	Min. bending radius (mm)	Weight (g/m)	Standard color (color symbol)					
					Black	Milky white	Yellow	Blue	Green	Red
					BK	MW	YL	BU	GN	RE
N5-4-4×2	4×2	1.8	10	11	●	○	●	●	●	●
N5-4-4×2.5	4×2.5	1.2	15	8	●	○	—	—	—	—
N5-4-4×3	4×3	0.7	20	6	●	○	●	●	●	●
N5-4-6×4	6×4	1.1		17	●	○	●	●	●	●
N5-4-6×4.5	6×4.5	0.7	35	13	●	○	●	●	●	●
N5-4-8×6	8×6			23	●	○	●	●	●	●
N5-4-10×7.5	10×7.5	0.6	45	35	●	○	●	●	●	●
N5-4-10×8	10×8			29	●	○	●	●	●	●
N5-4-12×9	12×9	0.7	100	51	●	○	—	—	—	—
N5-4-16×13	16×13	0.6		70	●	○	—	—	—	—

● Inch size type (Group 1)

Type	Outer diameter × Inner diameter (mm)	Max. working pressure (MPa at 20°C)	Min. bending radius (mm)	Weight (g/m)	Standard color (color symbol)	
					Black	Milky white
					BK	MW
N5-1-3/16	4.76×3.48	0.8	16.0	9.0	●	○
N5-1-1/4	6.35×4.57		23.0	16.0	●	○
N5-1-5/16	7.94×5.90		29.0	23.0	●	○
N5-1-3/8	9.53×6.99		35.0	35.0	●	○
N5-1-1/2	12.70×9.56		45.0	58.0	●	○

Standard length

20M, 100M

Product number example

N5 - 4 - 6x4 - BK - 100M

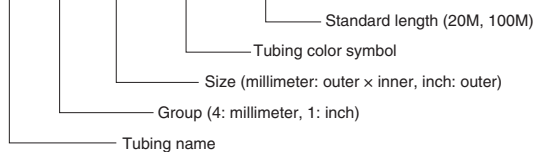

Applicable fittings



Related products and product introduction



Operating fluid, working temperature range

Operating fluid	Working temperature range
Air	-40°C~+100°C
Water	0°C~+50°C
General operating oil	-40°C~+100°C

☎ Contact us for other operating fluids.

Negative pressure performance

-101.294kPa

Relation between the working temperature and the maximum working pressure

The maximum working pressure varies with the working temperature (environmental temperature). For use at an abnormal temperature, always check the maximum working pressure change in the graph below and keep the pressure within the indicated range.

⚠ Caution: Using tubes at a pressure outside the range may cause accidents or damage, for which Nitta is not liable.

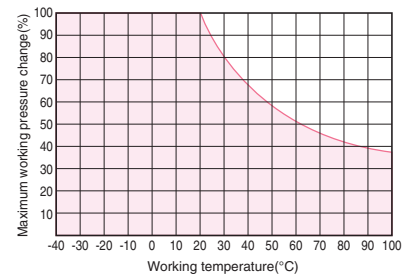

Handling instructions

⚠ Caution: When water is used as the operating fluid, the tubing material might degrade depending on the additive. Contact us for details.

⚠ Caution: When water is used as the operating fluid, keep the surge pressure below the maximum working pressure. Also, do not allow the water to freeze.

☞ See page 10 for common instructions for tubing products.

Reference

Chemical resistance specification tableP.198
Effective sectional area ...P.168
Negative-pressure performance listP.169

Nylon Tubing

N1

Hard (unplasticized) nylon

Features

- 100% unplasticized nylon resin tubing.
- Suitable for high pressure application.
- Usable at a high temperature (up to 120°C).



Product number table

● Millimeter size type (Group 4)

Type	Outer diameter × Inner diameter (mm)	Max. working pressure (MPa at 20°C)	Min. bending radius (mm)	Weight (g/m)	Standard color (color symbol)	
					Black	Milky white
					BK	MW
N1-4-6×4	6×4	5.0	20.0	17.0	●	○
N1-4-8×6	8×6	3.3	30.0	23.0	●	○

● Inch size type (Group 1)

Type	Outer diameter × Inner diameter (mm)	Max. working pressure (MPa at 20°C)	Min. bending radius (mm)	Weight (g/m)	Standard color (color symbol)	
					Black	Milky white
					BK	MW
N1-1-1/4	6.35×4.57	4.0	23.0	16.0	●	○

Standard length

20M, 100M

Product number example

N1 - 4 - 6x4 - BK - 100M

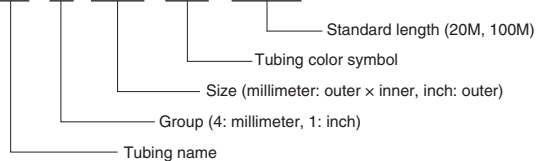

Operating fluid, working temperature range

Operating fluid	Working temperature range
Air	-40°C~+120°C
Water	0°C~+70°C
General operating oil	-40°C~+120°C

☞ Contact us for other operating fluids.

Negative pressure performance

-101.294kPa

Relation between the working temperature and the maximum working pressure

The maximum working pressure varies with the working temperature (environmental temperature). For use at an abnormal temperature, always check the maximum working pressure change in the graph below and keep the pressure within the indicated range.

⚠ Caution: Using tubes at a pressure outside the range may cause accidents or damage, for which Nitta is not liable.



Handling instructions

⚠ Caution: When water is used as the operating fluid, the tubing material might degrade depending on the additive. Contact us for details.

⚠ Caution: When water is used as the operating fluid, keep the surge pressure below the maximum working pressure. Also, do not allow the water to freeze.

☞ See page 10 for common instructions for tubing products.

Applicable fittings

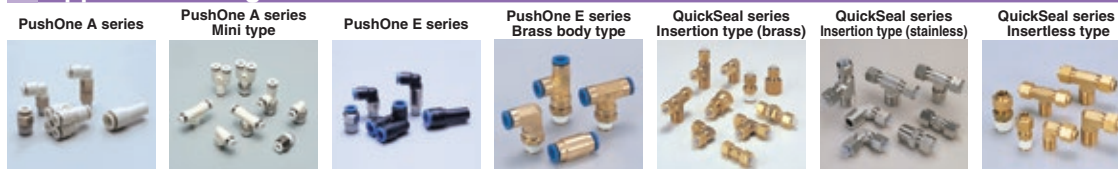

Related products and product introduction

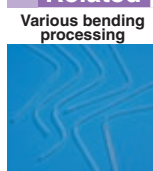

Contact us for 2- and 3-dimensional bending processing.

Reference

Chemical resistance specification tableP.198
Effective sectional area ...P.168
Negative-pressure performance listP.169

TES

For coating (flexible, abrasion resistant)

Features

- Bilayer structure of inner (special fluorocarbon resin) and outer (special nylon resin) layers.
- Super flexible and suitable for movable piping for robots.
- Highly smooth and highly chemical resistant inner surface, and highly abrasion resistant outer surface.
- The translucent tubing enables the fluid to be seen.

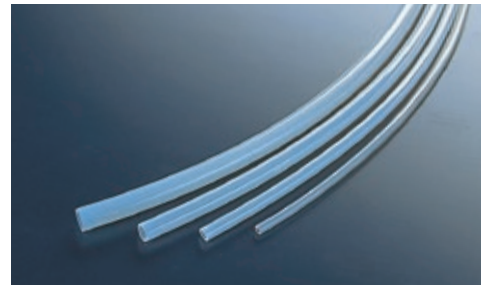

Structure diagram

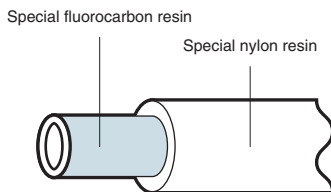

Product number table

● Millimeter size type (Group 4)

Type	Outer diameter × Inner diameter (mm)	Max. working pressure (MPa at 20°C)	Min. bending radius (mm)	Weight (g/m)	Standard color (color symbol)	
					Translucent	CWH
TES-4-4×2.5	4×2.5	1.8	15	9	○	○
TES-4-6×4	6×4	1.8	20	18	○	○
TES-4-8×6	8×6	1.5	35	26	○	○
TES-4-10×8	10×8	1.1	50	33	○	○

● Inch size type (Group 1)

Type	Outer diameter × Inner diameter (mm)	Max. working pressure (MPa at 20°C)	Min. bending radius (mm)	Weight (g/m)	Standard color (color symbol)	
					Translucent	CWH
* TES-1-1/4	06.35×4.57	1.4	25	18	○	○
* TES-1-3/8	9.53×6.99		40	37	○	○
* TES-1-1/2	12.70×9.56		55	61	○	○

* Made to Order

Standard length

20M, 100M

Product number example

TES - 4 - 6x4 - CWH - 100M

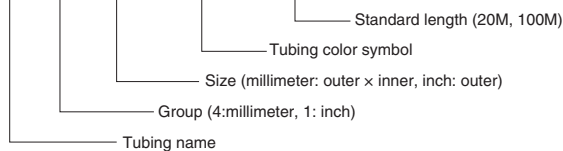

Applicable fittings

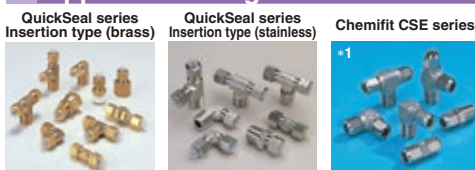

(*1) Combinatory use of TES tubing and Chemifit series mixes general and clean type performances. When using them together in a clean environment, be aware of how this could lower the cleanliness level.

Operating fluid, working temperature range

Operating fluid	Working temperature range
Air	-40°C~+100°C
Water	0°C~+70°C
Water-based paint (*)	0°C~+40°C

(*) Water-based paint, or aliphatic or aromatic carbon hydride solvent.
☎ Contact us for other operating fluids.

Negative pressure performance

-101.294kPa

Relation between the working temperature and the maximum working pressure

The maximum working pressure varies with the working temperature (environmental temperature). For use at an abnormal temperature, always check the maximum working pressure change in the graph below and keep the pressure within the indicated range.

⚠ Caution: Using tubes at a pressure outside the range may cause accidents or damage, for which Nitta is not liable.

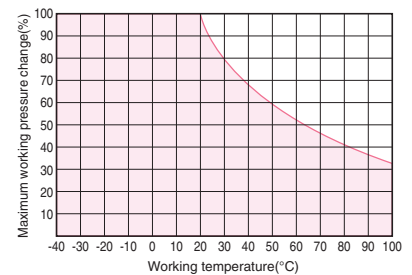

Handling instructions

⚠ Caution: When water is used as the operating fluid, the tubing material might degrade depending on the additive. Contact us for details.

⚠ Caution: When water is used as the operating fluid, keep the surge pressure below the maximum working pressure. Also, do not allow the water to freeze.

☞ See page 10 for common instructions for tubing products.

Reference

TES Tubing
Technology DataP.189
Chemical resistance
specification tableP.189
Effective sectional areaP.188
Negative-pressure
performance listP.169

Flame-resistant Tubing

FUK

For spot welding piping (flexible)

Features

- A double-layer structure which adopts a flame-retardant resin (equivalent to UL-94 standard V-0) for the outer layer and an ether-based polyurethane resin for the inner layer.
- Excellent in flexibility, abrasion resistance and sliding properties.
- With no need to peel off the outer layer, it requires less effort in pipe installation.
- Our line-up of products with increased inner diameters contributes to the increase in flow volume.

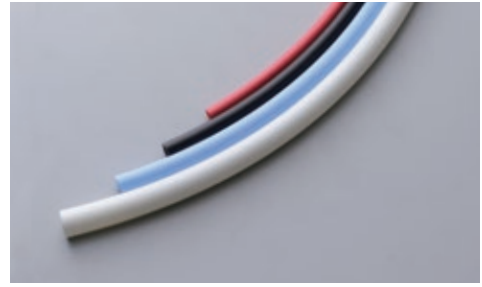

Product number table

- Millimeter size type (Group 4)

Type	Outer diameter × Inner diameter (mm)	Max. working pressure (Mpa at 20°C)	Min. bending radius (mm)	Weight (g/m)	Standard color (color symbol)								
					Black	White	Yellow	Blue	Green	Red	Light green	Pink	
					BK	WH	YL	BU	GN	RE	LGN	PK	
FUK-4-6×4	6×4	(Air)0.8	20	19	●	○	●	●	●	●	—	—	
FUK-4-8×5	8×5	(Water)0.7	20	37	●	○	●	●	●	●	—	—	
FUK-4-10×6.5	10×6.5		25	54	●	○	●	●	●	●	—	—	
*1 FUK-4-10×7	10×7	(Air)0.7(Water)0.6	35	48	●	○	●	●	●	●	●	●	
FUK-4-12×8	12×8	(Air)0.8(Water)0.7	35	74	●	○	●	●	●	●	●	●	
*1 FUK-4-12×8.5	12×8.5	(Air)0.7(Water)0.6	40	67	●	○	●	●	●	●	●	●	

*1 The applicable fittings are only the ones in PushOne series.

Standard length

20M, 100M

Product number example

FUK - 4 - 12×8 - WH - 100M

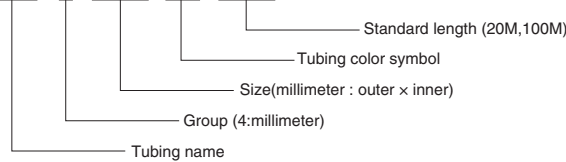

Flexibility data

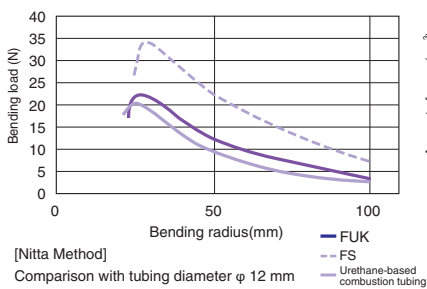

Abrasion resistance

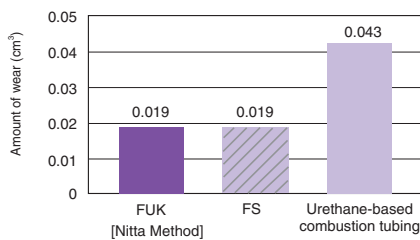

Operating fluid, working temperature range

Operating fluid	Working temperature range
Air	-40°C~+80°C
Water	0°C~+60°C

Relation between the working temperature and the maximum working pressure

The maximum working pressure varies with the working temperature (environmental temperature). For use at an abnormal temperature, always check the maximum working pressure change in the graph below and keep the pressure within the indicated range.

⚠ Caution: Using tubes at a pressure outside the range may cause accidents or damage, for which Nitta is not liable.

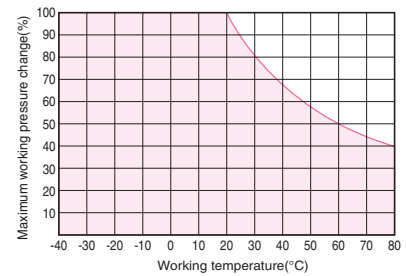

Handling instructions

⚠ Caution: When water is used as the operating fluid, the tubing material might degrade depending on the additive. Contact us for details.

⚠ Caution: When water is used as the operating fluid, keep the surge pressure below the maximum working pressure. Also, do not allow the water to freeze.

📖 See page 10 for common Instructions for tubing products.

Applicable fittings



(*1) When QuickSeal series fittings are used on a spatter-resistant line, replace the nylon sleeve with a brass sleeve.

(*2) Combinatory use of FUK tubing and Chemifit series mixes general and clean type performances.

When using them together in a clean environment, be aware of how this could lower the cleanliness level.

Related products and product introduction

Spatter Cap



Reference

Effective sectional area ···P.168

Flame-resistant Tubing

FS

For spot welding piping

Features

- Tubes which utilize a flame-retardant resin (equivalent to UL-94 standard V-0).
- Our line-up of products with increased inner diameters contributes to the increase in flow volume.
- Markings along the tubing as an insertion length indicator.



Product number table

● Millimeter size type (Group 4)

Type	Outer diameter × Inner diameter (mm)	Max. working pressure (MPa at 20°C)	Min. bending radius (mm)	Weight (g/m)	Standard color (color symbol)									
					Black	White	Yellow	Blue	Green	Red	Light cream	Light green	Pink	
					BK	WH	YL	BU	GN	RE	LCM	LGN	PK	
FS-4-4×2.5	4×2.5	1.0	10	10	●	○	●	●	●	●	—	—	—	
FS-4-6×4	6×4		15	21	●	○	●	●	●	●	●	—	—	
FS-4-8×5	8×5	1.2	15	40	●	○	●	●	●	●	—	—	—	
*1 FS-4-8×5.5	8×5.5	0.9	20	36	●	○	●	●	●	●	●	—	—	
FS-4-10×6.5	10×6.5	1.0	20	60	●	○	●	●	●	●	—	—	—	
*1 FS-4-10×7	10×7	0.9	25	55	●	○	●	●	●	●	●	●	●	
FS-4-12×8	12×8	1.0	30	82	●	○	●	●	●	●	—	—	—	
*1 FS-4-12×8.5	12×8.5	0.9	30	77	●	○	●	●	●	●	●	●	●	
FS-4-16×12	16×12	0.7	80	106	—	—	—	●	—	—	—	—	—	

*1 Insertion type fittings of QuickSeal series cannot be used for FS tubing because of different inner diameters.
*2 Made to Order

Standard length

20M, 100M FS-4-16x12: 50M only

Product number example

FS - 4 - 6x4 - BK - 100M

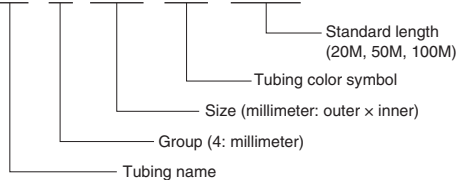

Insertion length markings

Markings along the tubing as an insertion length indicator.



Operating fluid, working temperature range

Operating fluid	Working temperature range
Air	-40°C~+100°C
Water	0°C~+70°C

Negative pressure performance

-101.294kPa

Relation between the working temperature and the maximum working pressure

The maximum working pressure varies with the working temperature (environmental temperature). For use at an abnormal temperature, always check the maximum working pressure change in the graph below and keep the pressure within the indicated range.

Caution: Using tubes at a pressure outside the range may cause accidents or damage, for which Nitta is not liable.

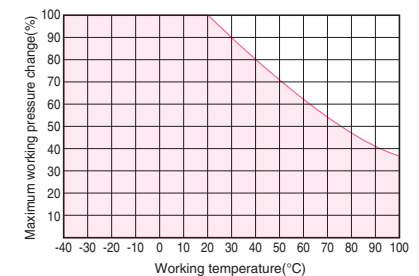

Handling instructions

Caution: When water is used as the operating fluid, the tubing material might degrade depending on the additive. Contact us for details.

Caution: When water is used as the operating fluid, keep the surge pressure below the maximum working pressure. Also, do not allow the water to freeze.

See page 10 for common instructions for tubing products.

Applicable fittings



(*1) When QuickSeal series fittings are used on a spatter-resistant line, replace the nylon sleeve with a brass sleeve.

Related products and product introduction

Spatter cap



Reference

Flame test of UL-94 standardP.195
Effective sectional area ...P.168
Negative-pressure performance listP.169

Flame-resistant Tubing

FW

For spot welding piping (bilayer)

Features

- A double-layer structure with a flame-retardant resin (equivalent to UL-94 standard V-0) for inner and outer layers.
- Markings along the tubing as an insertion length indicator.



Product number table

● Millimeter size type (Group 4)

Type	Inner tubing Outer diameter × Inner diameter (mm)	Outer cover Cover thickness	Max. working pressure (MPa at 20°C)	Min. bending radius (mm)	Weight (g/m)	Standard color (color symbol)									
						Inner tubing	Outer cover								
							Black	White	Yellow	Blue	Green	Red	Light green	Pink	Greenish white
BK	WH	YL	BU	GN	RE	LGN	PK	GWH							
FW-4-6×4	6×4	1.0	1.0	14	49	Black	●	○	●	●	●	●	—	—	○
FW-4-8×6	8×6	1.0	0.8	23	65		●	○	●	●	●	●	—	—	○
FW-4-10×7.5	10×7.5	1.0		27	89		●	○	●	●	●	●	●	●	○
FW-4-12×9	12×9	1.0	31	116	●		○	—	●	●	●	●	●	○	

⚠ Caution: Before using FW tubes, peel off outer covers.
Use Nitta's special cutter (TC02, TC03) to peel off covers.

Standard length

20M, 100M 📏 FW-4-12x9: 50M only

Product number example

FW - 4 - 6x4 - BK - 100M

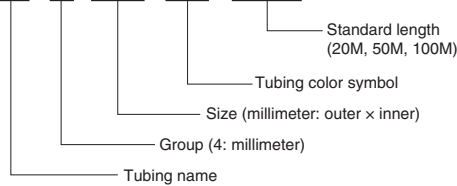

Insertion length markings

Markings along the tubing as an insertion length indicator.



Operating fluid, working temperature range

Operating fluid	Working temperature range
Air	-40°C~+80°C
Water	0°C~+70°C

Negative pressure performance

-101.294kPa

Relation between the working temperature and the maximum working pressure

The maximum working pressure varies with the working temperature (environmental temperature). For use at an abnormal temperature, always check the maximum working pressure change in the graph below and keep the pressure within the indicated range.

⚠ Caution: Using tubes at a pressure outside the range may cause accidents or damage, for which Nitta is not liable.

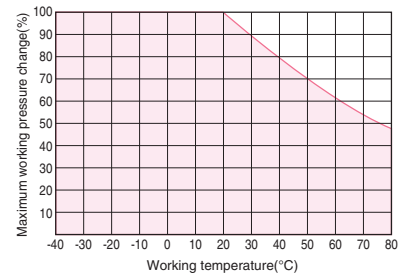

Handling instructions

⚠ Caution: When water is used as the operating fluid, the tubing material might degrade depending on the additive. Contact us for details.

⚠ Caution: When water is used as the operating fluid, keep the surge pressure below the maximum working pressure. Also, do not allow the water to freeze.

📖 See page 10 for common instructions for tubing products.

Applicable fittings



(*1) When QuickSeal series fittings are used on a spatter-resistant line, replace the nylon sleeve with a brass sleeve.

Related products and product introduction

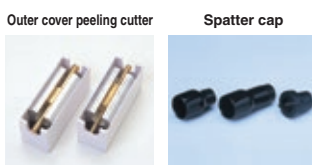

Reference

UL-94 standard flame testP.195
Effective sectional area ...P.168
Negative-pressure performance list.....P.169

Tubing

Clean tubing

Processed tubing

PushOne fitting

QuickSeal fitting

Clean fitting/Chemifit

Bamboo-shoot fitting

Control switch/Detachable series

Jig/Tool/Accessory

Technical information

Reference

Flame-resistant Tubing

FWU

For spot welding piping (flexible)

Features

- Tubes with higher flexibility than FW, with a double-layer structure which utilizes a flame-retardant resin (equivalent to UL-94 standard V-0) for the outer layer and an ether-based polyurethane resin for the inner layer.
- Markings along the tubing as an insertion length indicator.

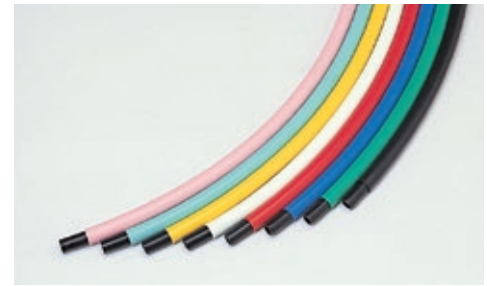

Product number table

● Millimeter size type (Group 4)

Type	Inner tubing Outer diameter × Inner diameter (mm)	Outer cover Cover thickness	Max. working pressure (MPa at20°C)	Min. bending radius (mm)	Weight (g/m)	Standard color (color symbol)								
						Inner tubing	Outer cover							
							Black	Red	Blue	Green	Yellow	Light green	Pink	Greenish white
BK	RE	BU	GN	YL	LGN	PK	GWH							
FWU-4-6x4	6x4	1.0	0.9	14	50	●	—	—	—	—	—	—	—	—
FWU-4-8x5	8x5	1.0		20	73	●	—	—	—	—	—	—	—	—
FWU-4-10x6.5	10x6.5	1.0	0.6	30	98	●	●	●	—	—	●	●	●	
FWU-4-12x8	12x8	1.0		35	126	●	●	●	●	●	●	●	●	

⚠ Caution Before using FWU tubes, peel off outer covers.
Use Nitta's special cutter (TC02, TC03) to peel off covers.

Standard length

20M, 100M 📏 FWU-4-12x8: 50M only

Product number example

FWU - 4 - 6x4 - BK - 100M

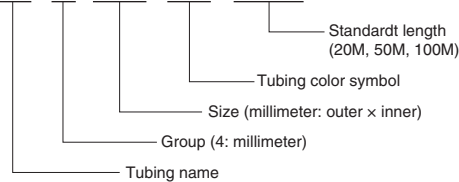

Insertion length markings

Markings along the tubing as an insertion length indicator.



Operating fluid, working temperature range

Operating fluid	Working temperature range
Air	-40°C~+80°C
Water	0°C~+50°C

Negative pressure performance

-101.294kPa

Relation between the working temperature and the maximum working pressure

The maximum working pressure varies with the working temperature (environmental temperature). For use at an abnormal temperature, always check the maximum working pressure change in the graph below and keep the pressure within the indicated range.

⚠ Caution: Using tubes at a pressure outside the range may cause accidents or damage, for which Nitta is not liable.

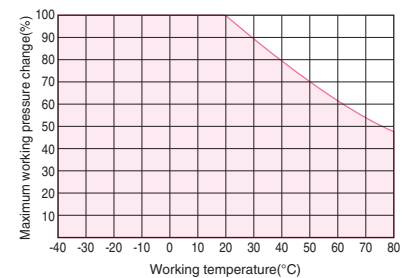

Handling instructions

⚠ Caution: When water is used as the operating fluid, the tubing material might degrade depending on the additive. Contact us for details.

⚠ Caution: When water is used as the operating fluid, keep the surge pressure below the maximum working pressure. Also, do not allow the water to freeze.

📖 See page 10 for common instructions for tubing products.

Applicable fittings

PushOne A series



PushOne E series



PushOne E series
Brass body type



QuickSeal series
Insertion type (brass)



(*1) When QuickSeal series fittings are used on a spatter-resistant line, replace the nylon sleeve with a brass sleeve.

Related products and product introduction

Outer cover peeling cutter



Spatter cap



Reference

UL-94 standard
flame testP.195
Effective sectional area.....P.168
Negative-pressure
performance list.....P.169

Antistatic Tubing

UE

For general air pressure (electrically conductive)

Features

- Conductive polyurethane elastomer is used to prevent build-up of electrostatic charge that could result in sparks. (Surface resistance 10^5 - $10^3\Omega$)
- Super flexible.

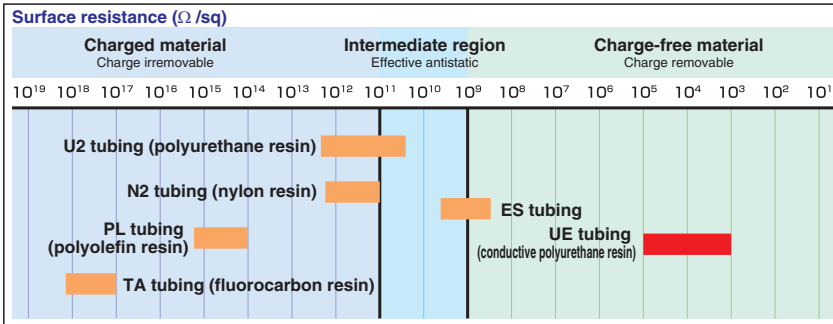

Product number table

● Millimeter size type (Group 4)

Type	Outer diameter × Inner diameter (mm)	Max. working pressure (MPa at 20°C)	Min. bending radius (mm)	Weight (g/m)	Standard color (color symbol)
					Black BK
UE-4-4×2.5	4×2.5	0.8	10	10	●
UE-4-6×4	6×4		15	20	●
UE-4-8×5	8×5		23	39	●
UE-4-10×6.5	10×6.5		30	57	●
UE-4-12×8	12×8		35	79	●

Standard length

20M, 100M

Product number example

UE - 4 - 6×4 - BK - 100M

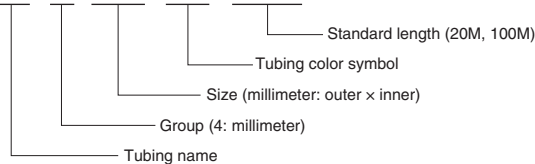

Applicable fittings



(*1) When a PushOne series is used with a UE tubing, choose a metal type of body including a connector and an internal connector or a brass body type from the PushOne E series to maintain electric conductivity between the tubing and the fittings.

(*2) Combinatory use of UE tubing and Chemifit series mixes general and clean type performances. When using them together in a clean environment, be aware of how this could lower the cleanliness level.

Operating fluid, working temperature range

Operating fluid	Working temperature range
Air	-40°C~+80°C

Negative pressure performance

-101.294kPa

Relation between the working temperature and the maximum working pressure

The maximum working pressure varies with the working temperature (environmental temperature). For use at an abnormal temperature, always check the maximum working pressure change in the graph below and keep the pressure within the indicated range.

⚠ Caution: Using tubes at a pressure outside the range may cause accidents or damage, for which Nitta is not liable.

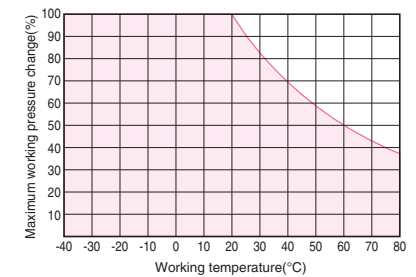

Handling instructions

⚠ Caution: When the PushOne series is used with a UE tubing, choose a metal type of body including a connector and an internal connector or a brass body type from the PushOne E series to maintain electric conductivity between the tubing and the fittings.

👉 See page 10 for common instructions for tubing products.

Reference

Effective sectional area.....P.168
Negative-pressure performance list.....P.169

Shape-keeping Tubing

DK

For retaining shape and fixed piping in absence of clamp

Features

- Aluminum is used for the inner layer for maintaining the shape. Suitable for fixed piping.
- Better workability compared to copper piping if DK fittings are used. Tubing end processing is not necessary.



Structure diagram

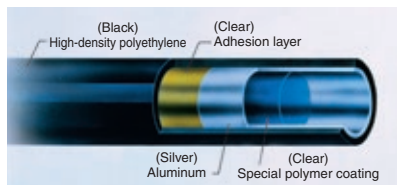

Product number example

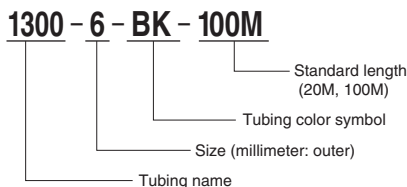

Product number table

● Millimeter size type (Group 4)

Type	Outer diameter × Inner diameter (mm)	Max. working pressure (MPa at 20°C)	Min. bending radius (mm)	Weight (g/m)	Standard color (color symbol)
					Black BK
1300-6	6×4	1.0	20	21	●
1300-10	10×6.8		40	47	●

Applicable fittings

QuickSeal series DK tubing dedicated typeP.98

Polybutene Tubing

PB

For food processing machines

Features

- Suitable for piping that requires high temperature antimicrobial cleaning of food processing machines.
- Compliant with the MHLW Ministerial Notification No.201(2006), MHW Ministerial Notification No.370(1959), Japan.



Product number table

● Inch size type (Group 1)

Type	Outer diameter × Inner diameter (mm)	Max. working pressure (MPa at 20°C)	Min. bending radius (mm)	Weight (g/m)	Standard color (color symbol)
					Milky white MW
* PB-1-1/4	6.35×4.57	1.1	25	14	○
* PB-1-3/8	9.53×6.99		30	30	○
* PB-1-1/2	12.70×9.56		40	50	○

* Made to Order

Product number example

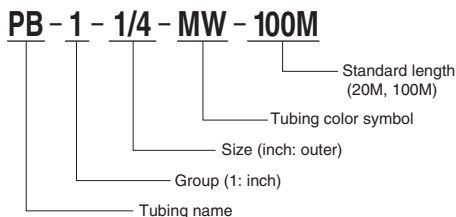

Handling instructions

⚠ Caution: When water is used as the operating fluid, the tubing material might degrade depending on the additive. Contact us for details.

⚠ Caution: When water is used as the operating fluid, keep the surge pressure below the maximum working pressure. Also, do not allow the water to freeze.

👉 See page 10 for common instructions for tubing products.

Applicable fittings

QuickSeal series Insertion type (brass), QuickSeal series Insertion type (stainless) Chemifit CSE series.*1

(*1) Combinatory use of PB tubing and Chemifit series mixes general and clean type performances. When using them together in a clean environment, be aware of how this could lower the cleanliness level.

Reference

Chemical resistance specification tableP.198 Effective sectional areaP.168 Negative-pressure performance listP.169

Operating fluid, working temperature range

Operating fluid	Working temperature range
Air	-40°C~+60°C

Negative pressure performance

-101.294kPa

Relation between the working temperature and the maximum working pressure

The maximum working pressure of DK tubing does not decrease by temperature as far as within the working temperature (environment temperature) range.

Handling instructions

⚠ Caution: DK tubing cannot be used for movable applications.

👉 See page 10 for common instructions for tubing products.

Reference

Effective cross area P.168
Negative-pressure performance list P.169

Operating fluid, working temperature range

Operating fluid	Working temperature range
Air	-10°C~+90°C
Water	0°C~+90°C

Negative pressure performance

-101.294kPa

Relation between the working temperature and the maximum working pressure

The maximum working pressure varies with the working temperature (environmental temperature). For use at an abnormal temperature, always check the maximum working pressure change in the graph below and keep the pressure within the indicated range.

⚠ Caution: Using tubes at a pressure outside the range may cause accidents or damage, for which Nitta is not liable.

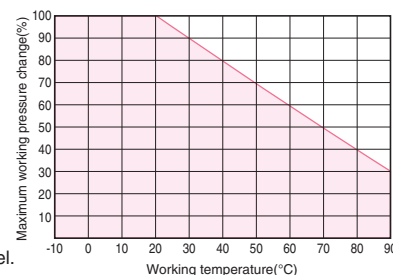

ES

Prevention of dielectric breakdown

Features

- With antistatic performance of surface resistivity $10^{11} \Omega/\text{sq}$ or lower, it does not allow dust to gather.
- There is no bleed-out of conductive agent, and no environmental pollution with particles and other debris.
- Excellent resistance to fluorine-based inert fluids.

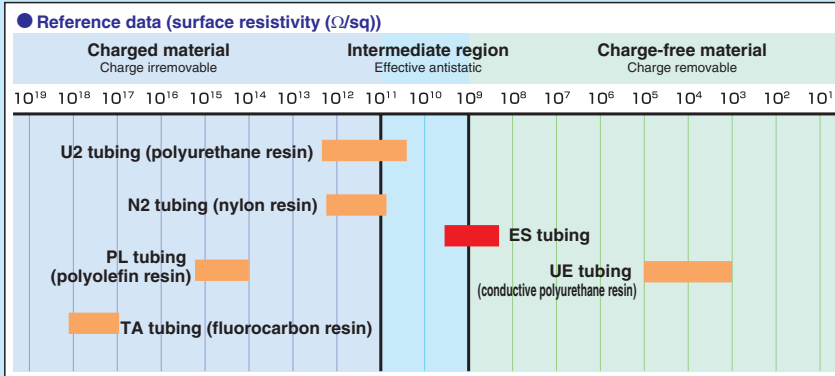

Product number table

- Millimeter size type (Group 4)
- Inch size type (Group 1)

Type	Outer diameter × Inner diameter (mm)	Max. working pressure (MPa at 20°C)	Min. bending radius (mm)	Weight (g/m)	Standard color (color symbol)	
					White	WH
ES-4-4×2.5	4×2.5	0.7	15	10	○	
ES-4-6×4	6×4		25	19	○	
ES-4-8×6	8×6	0.5	35	26	○	
ES-4-10×8	10×8		60	33	○	
ES-4-12×9	12×9	0.6	50	60	○	
ES-1-1/2	12.70×9.56	0.5		66	○	

*Please contact us for other sizes.

Standard length

20M

Product number example

ES-4-6×4-WH-20M

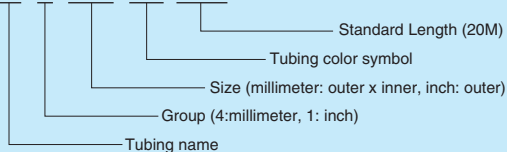

*Only 20 m products are available.

Applicable fittings



(*1) Combinatory use of ES tubing and QuickSeal series mixes general and clean type performances. When using them together in a clean environment, be aware of how this could lower the cleanliness level.

Operating fluid, working temperature range

Operating fluid	Working temperature range
Air (clean air)	-50°C~+80°C
Fluorine-based inert fluid	-50°C~+50°C

- ☞ Contact us for various chemical liquids.
- ☞ See "Combination List of Tubing and Fitting" on page 8.

Relation between the working temperature and the maximum working pressure

The maximum working pressure varies with the working temperature (environmental temperature). For use at an abnormal temperature, always check the maximum working pressure change in the graph below and keep the pressure within the indicated range.

⚠ Caution: Using tubes at a pressure outside the range may cause accidents or damage, for which Nitta is not liable.

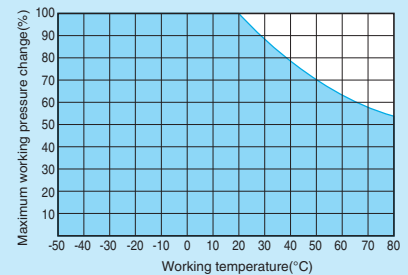

Handling instructions

⚠ Caution: When water is used as the operating fluid, keep the surge pressure below the maximum working pressure. Also, do not allow the water to freeze.

☞ See page 10 for common Instructions for tubing products.

Reference

Chemical resistance specification tableP.198
Effective sectional areaP.168

Polyolefin Resin Tubing

PL

For clean piping (flexible)

Features

- A clean tubing suitable for equipment and applications with fluids such as clean air, N2 gas, pure water and various chemical liquids.
- Environment-friendly eco tubing. When burned at 750°C, PL tubing generates only carbon dioxide gas, no nitrogen oxides (NOx), no sulfur oxides (SOx), and absolutely no dioxin.
- Produced, end-sealed, heat-sealed for shipping in a cleanroom.
- Made of special polyolefin resin with high water barrier performance and flexibility
- Low cost compared to fluorocarbon resin tubes.
- Compliant with the MHLW Ministerial Notification No.201(2006), MHW Ministerial Notification No.370(1959), Japan.



Operating fluid, working temperature range

Operating fluid	Working temperature range
Air (clean air)	-60°C~+80°C
Water (pure water)	0°C~+80°C

Contact us for various chemical liquids.
See "Combination List of Tubing and Fitting" on page 8.

Negative pressure performance

-101.294kPa

Relation between the working temperature and the maximum working pressure

The maximum working pressure varies with the working temperature (environmental temperature). For use at an abnormal temperature, always check the maximum working pressure change in the graph below and keep the pressure within the indicated range.

⚠ Caution: Using tubes at a pressure outside the range may cause accidents or damage, for which Nitta is not liable.

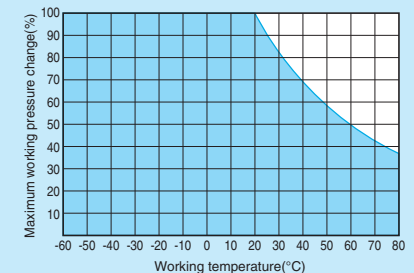

Handling instructions

⚠ Caution: When water is used as the operating fluid, the tubing material might degrade depending on the additive. Contact us for details.

⚠ Caution: When water is used as the operating fluid, keep the surge pressure below the maximum working pressure. Also, do not allow the water to freeze.

See page 10 for common instructions for tubing products.

Product number table

● Millimeter size type (Group 4)

Type	Outer diameter × Inner diameter (mm)	Max. working pressure (MPa at 20°C)	Min. bending radius (mm)	Weight (g/m)	Standard color (color symbol)					
					Black	Milky white	Red	Blue	Yellow	Green
					BK	MW	RE	BU	YL	GN
PL-4-4×2	4×2	1.5	15	10	●	○	●	●	●	●
PL-4-6×4	6×4	1.0	25	15	●	○	●	●	●	●
PL-4-8×6	8×6	0.7	35	20	●	○	●	●	●	●
PL-4-10×7.5	10×7.5		45	30	—	○	—	—	—	—
PL-4-10×8	10×8	0.5	45	25	●	○	●	●	●	●
PL-4-12×9	12×9	0.7		45	●	○	●	●	●	●

● Inch size type (Group 1)

Type	Outer diameter × Inner diameter (mm)	Max. working pressure (MPa at 20°C)	Min. bending radius (mm)	Weight (g/m)	Standard color (color symbol)					
					Black	Milky white	Red	Blue	Yellow	Green
					BK	MW	RE	BU	YL	GN
PL-1-1/4	6.35×4.57	0.7	30	14	●	○	●	●	●	●
PL-1-3/8	9.53×6.99		40	30	●	○	●	●	●	●
PL-1-1/2	12.70×9.56		55	50	●	○	●	●	●	●

● Inch size type (Group 5)

Type	Outer diameter × Inner diameter (mm)	Outer diameter	Max. working pressure (MPa at 20°C)	Min. bending radius (mm)	Weight (g/m)	Standard color (color symbol)	
						Milky white	MW
						○	○
PL-5-3.18×2	3.18×2	1/8	0.9	7	4	○	○

Applicable fittings for Group 5 are Chemifit C1 series and Chemifit C1S series with the same outer diameter.

Product number example

PL - 4 - 6x4 - BK - 100M

Standard length

20M, 100M

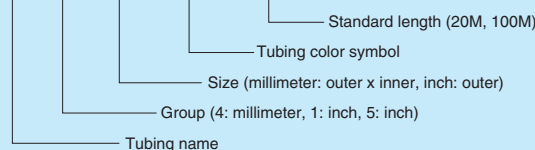

Applicable fittings



Applicable fittings



Related products and product introduction



Reference

Chemical resistance specification tableP.198
Effective sectional area ...P.168
Negative-pressure performance listP.169

(*1) Combinatory use of PL tubing and PushOne series / QuickSeal series mixes general and clean type performances. When using them together in a clean environment, be aware of how this could lower the cleanliness level.

Tubing

Clean tubing

Processed tubing

PushOne fitting

QuickSeal fitting

Clean fitting/ Chemifit

Bamboo-shoot fitting

Control switch/ Detachable series

Jig/Tool/ Accessory

Technical information

Reference

Polyolefin Resin Tubing

PN

For clean piping (Super flexible)

Features

- A clean tubing suitable for equipment and applications with fluids such as clean air, N2 gas, pure water and various chemical liquids.
- Environment-friendly eco tubing. When burned at 750°C, PL tubing generates only carbon dioxide gas, no nitrogen oxides (NOx), no sulfur oxides (SOx), and absolutely no dioxin.
- Produced, end-sealed, heat-sealed for shipping in a cleanroom.
- Made of special polyolefin resin with high water barrier performance and higher flexibility than PL tubes.
- Low cost compared to fluorocarbon resin tubes.
- Compliant with the MHLW Ministerial Notification No.201(2006), MHW Ministerial Notification No.370(1959), Japan.



Operating fluid, working temperature range

Operating fluid	Working temperature range
Air (clean air)	-60°C~+80°C
Water (pure water)	0°C~+80°C

Contact us for various chemical liquids.

See "Combination List of Tubing and Fitting" on page 8.

Negative pressure performance

-101.294kPa

Relation between the working temperature and the maximum working pressure

The maximum working pressure varies with the working temperature (environmental temperature). For use at an abnormal temperature, always check the maximum working pressure change in the graph below and keep the pressure within the indicated range.

Caution: Using tubes at a pressure outside the range may cause accidents or damage, for which Nitta is not liable.

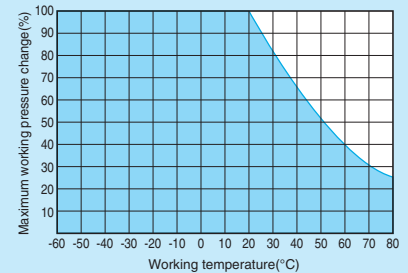

Handling instructions

Caution: When water is used as the operating fluid, the tubing material might degrade depending on the additive. Contact us for details.

Caution: When water is used as the operating fluid, keep the surge pressure below the maximum working pressure. Also, do not allow the water to freeze.

See page 10 for common instructions for tubing products.

Product number table

● Millimeter size type (Group 4)

Type	Outer diameter × Inner diameter (mm)	Max. working pressure (MPa at 20°C)	Min. bending radius (mm)	Weight (g/m)	Standard color (color symbol)						
					Black	Milky white	Clear red	Clear blue	Clear yellow	Clear green	
					BK	MW	CRE	CBU	CYL	CGN	
PN-4-3×2	3×2	0.7	7	4	●*	○	●*	●*	●*	●*	●*
PN-4-4×2.5	4×2.5		10	7	●	○	●	●	●	●	●
PN-4-6×4	6×4		20	14	●	○	●	●	●	●	●
PN-4-8×5	8×5		28	28	●	○	●	●	●	●	●
PN-4-10×6.5	10×6.5		30	41	●*	○	●*	●*	●*	●*	●*
PN-4-12×8	12×8		40	57	●*	○	●*	●*	●*	●*	●*

* Made to Order

● Inch size type (Group 1)

Type	Outer diameter × Inner diameter (mm)	Max. working pressure (MPa at 20°C)	Min. bending radius (mm)	Weight (g/m)	Standard color (color symbol)						
					Black	Milky white	Clear red	Clear blue	Clear yellow	Clear green	
					BK	MW	CRE	CBU	CYL	CGN	
PN-1-1/4	6.35×4.57	0.5	20	14	●*	○*	●*	●*	●*	●*	●*
PN-1-3/8	9.53×6.99		30	30	●*	○*	●*	●*	●*	●*	●*
PN-1-1/2	12.70×9.56		50	50	●*	○*	●*	●*	●*	●*	●*

* Made to Order

Standard length

20M, 100M

Product number example

PN - 4 - 6x4 - MW - 100M

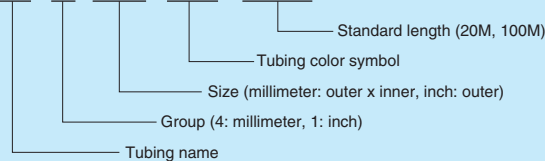

Applicable fittings



Applicable fittings



Related products and product introduction



Reference

Chemical resistance specification tableP.198
 Effective sectional area ...P.168
 Negative-pressure performance listP.169

(*1) Combinatory use of PN tubing and PushOne series / QuickSeal series mixes general and clean type performances. When using them together in a clean environment, be aware of how this could lower the cleanliness level.

Fluorocarbon Resin Tubing

TA

For clean, heat-resistant, cold-resistant, chemical-resistant use

Features

- PFA (copolymer of tetrafluoroethylene – perfluoroalkyl vinyl ether) resin tubing with high chemical resistance.
- Produced, end-sealed, heat-sealed for shipping in a cleanroom.
- Easy cleaning with little remaining fluid inside.
- Less aged deterioration and high weather resistance.
- Usable in ozone environment.
- Usable for clean fittings of Chemifit CSE series.
- Compliant with the MHLW Ministerial Notification No.201(2006), MHW Ministerial Notification No.370(1959), Japan.

Product number table

● Millimeter size type (Group 4)

Type	Outer diameter x Inner diameter (mm)	Max. working pressure (MPa at 20°C)	Min. bending radius (mm)	Weight (g/m)	Standard color (color symbol)	
					Translucent	CWH
TA-4-3x2	3x2	1.5	20	8.5	○	○
TA-4-4x2	4x2	2.5	25	20	○	○
TA-4-4x3	4x3	0.9	30	12	○	○
TA-4-6x4	6x4	1.6	30	34	○	○
TA-4-8x6	8x6	1.1	50	47	○	○
TA-4-10x8	10x8	0.8	70	61	○	○
TA-4-12x9	12x9	1.1	70	106	○	○
TA-4-12x10	12x10	0.7	100	74	○	○
* TA-4-14x12	14x12	0.6	150	89	○	○
* TA-4-17x14	17x14	0.7	300	159	○	○
TA-4-19x16	19x16	0.6	400	179	○	○
* TA-4-24x20	24x20		500	300	○	○
* TA-4-25x22	25x22	0.5	600	240	○	○

*Made to Order

● Inch size type (Group 1)

Type	Outer diameter x Inner diameter (mm)	Max. working pressure (MPa at 20°C)	Min. bending radius (mm)	Weight (g/m)	Standard color (color symbol)	
					Translucent	CWH
TA-1-1/4	6.35x4.57	1.1	30	33	○	○
TA-1-3/8	9.53x6.99	1.1	50	71	○	○
TA-1-1/2	12.70x9.56	1.1	60	118	○	○

● Inch size type (Group 5) Different inner diameter from Group 1

Type	Outer diameter x Inner diameter (mm)	Outer diameter	Max. working pressure (MPa at 20°C)	Min. bending radius (mm)	Weight (g/m)	Standard color (color symbol)	
						Translucent	CWH
TA-5-3.18x2	3.18x2	1/8	1.5	7	10	○	○
TA-5-6.35x3.96	6.35x3.96	1/4	1.7	45	42	○	○
TA-5-9.53x6.35	9.53x6.35	3/8	1.5	60	86	○	○
TA-5-12.7x9.53	12.70x9.53	1/2	1.1	90	120	○	○
* TA-5-19.1x15.9	19.10x15.9	3/4	0.6	400	186	○	○
* TA-5-25.4x22.2	25.40x22.2	1	0.5	600	240	○	○

☞ Applicable fittings for Group 5 are Chemifit C1 series and Chemifit C1S series with the same outer diameter.

*Made to Order

Product number example

TA - 4 - 6x4 - CWH - 100M

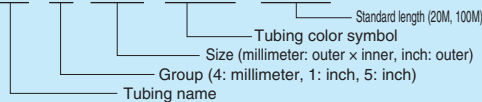

Standard length

20M, 100M

- ☞ TA-4- 14x12, 17x14, 19x16, 24x20, 25x22 and
- TA-5- 19.1x15.9, 25.4x22.2: 20M only

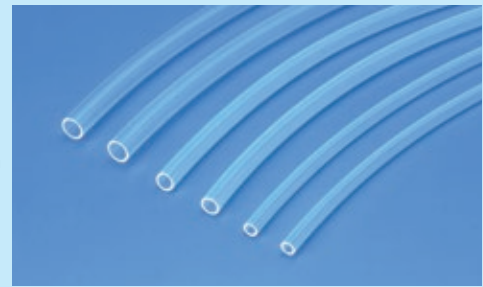

Operating fluid, working temperature range

Operating fluid	Working temperature range
Air (clean air)	-65°C~+260°C
Water (pure water)	0°C~+100°C

☞ Contact us for various chemical liquids.

☞ See "Combination List of Tubing and Fitting" on page 8.

Negative pressure performance

-101.294kPa

Relation between the working temperature and the maximum working pressure

The maximum working pressure varies with the working temperature (environmental temperature). For use at an abnormal temperature, always check the maximum working pressure change in the graph below and keep the pressure within the indicated range.

⚠ Caution: Using tubes at a pressure outside the range may cause accidents or damage, for which Nitta is not liable.

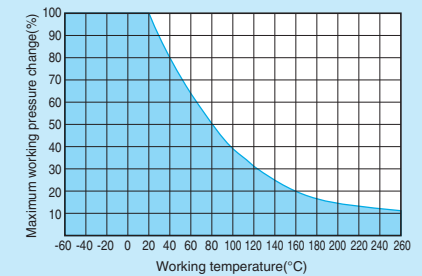

Handling instructions

⚠ Caution: When water is used as the operating fluid, keep the surge pressure below the maximum working pressure. Also, do not allow the water to freeze.

☞ See page 10 for common instructions for tubing products.

Applicable fittings

Chemifit C1 series 	Chemifit C1S series 	Chemifit CSE series 	Chemifit CP series 	PushOne A series 	PushOne A series Mini type 	PushOne E series 	PushOne E series Brass body type
-------------------------------	--------------------------------	--------------------------------	-------------------------------	-----------------------------	---------------------------------------	-----------------------------	---

Applicable fittings

QuickSeal series Insertion type (brass) 	QuickSeal series Insertion type (stainless)
--	--

Related products and product introduction

Chemifit C1 Speed controller 	Various bending processing
---	---------------------------------------

Products with high-graded PFA material are available on request. Contact us for details.

Reference

Chemical resistance specification tableP.198
Effective sectional area ...P.168
Negative-pressure performance listP.169

(*1) Combinatory use of TA tubing and PushOne series / QuickSeal series mixes general and clean type performances.

When using them together in a clean environment, be aware of how this could lower the cleanliness level.

(*2) Contact us for specifications.

Tubing
Clean tubing
Processed tubing
PushOne fitting
QuickSeal fitting
Clean fitting/Chemifit
Bamboo-shoot fitting
Control switch/Detachable series
Jig/Tool/Accessory
Technical information
Reference

TP

For clean, heat-resistant, cold-resistant, chemical-resistant use

Features

- FEP (copolymer of tetrafluoroethylene – hexafluoropropylene) resin tubing with high chemical resistance.
- Produced, end-sealed, heat-sealed for shipping in a cleanroom.
- Easy cleaning with extremely little remaining fluid inside.
- Usable for clean fittings of Chemifit C1 series.
- Less aged deterioration and high weather resistance.
- Usable in ozone environment.
- Compliant with the MHLW Ministerial Notification No.201(2006), MHW Ministerial Notification No.370(1959), Japan.

Product number table

● Millimeter size type (Group 4)

Type	Outer diameter × Inner diameter (mm)	Max. working pressure (MPa at 20°C)	Min. bending radius (mm)	Weight (g/m)	Standard color (color symbol)
					Translucent CWH
TP-4-4×2	4×2	2.5	15	20	○
TP-4-4×2.5	4×2.5	1.7	30	17	○
TP-4-6×4	6×4	1.6	25	34	○
TP-4-8×6	8×6	1.1	40	47	○
TP-4-10×8	10×8	0.8	60	61	○
TP-4-12×9	12×9	1.1		106	○
TP-4-12×10	12×10	0.7	90	74	○
TP-4-14×12	14×12	0.6	150	89	○
TP-4-21×18	21×18	0.6	500	200	○

*Made to Order

● Inch size type (Group 1)

Type	Outer diameter × Inner diameter (mm)	Max. working pressure (MPa at 20°C)	Min. bending radius (mm)	Weight (g/m)	Standard color (color symbol)
					Translucent CWH
TP-1-3/16	4.76×3.48	1.1	20	18	○
TP-1-1/4	6.35×4.57		30	33	○
TP-1-5/16	7.94×5.90		40	48	○
TP-1-3/8	9.53×6.99		50	71	○
TP-1-1/2	12.70×9.56		60	118	○

Product number example

TP - 4 - 6x4 - CWH - 100M

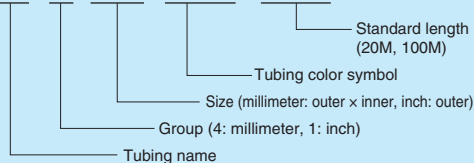

Standard length

20M, 100M
 ☞ TP-4-14×12,
 TP-4-21×18: 20M only

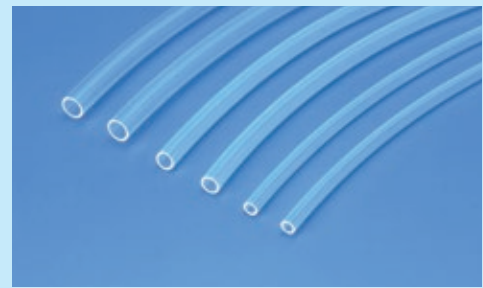

Operating fluid, working temperature range

Operating fluid	Working temperature range
Air (clean air)	-65°C~+200°C
Water (pure water)	0°C~+100°C

☞ Contact us for various chemical liquids.

☞ See "Combination List of Tubing and Fitting" on page 8.

Negative pressure performance

-101.294kPa

Relation between the working temperature and the maximum working pressure

The maximum working pressure varies with the working temperature (environmental temperature). For use at an abnormal temperature, always check the maximum working pressure change in the graph below and keep the pressure within the indicated range.

⚠ Caution: Using tubes at a pressure outside the range may cause accidents or damage, for which Nitta is not liable.

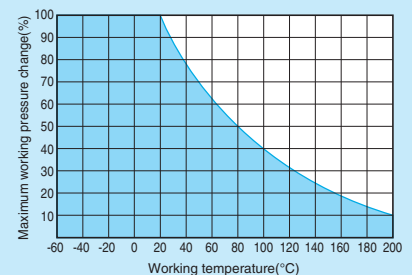

Handling instructions

⚠ Caution: When water is used as the operating fluid, keep the surge pressure below the maximum working pressure. Also, do not allow the water to freeze.

☞ See page 10 for common instructions for tubing products.

Applicable fittings

Chemifit C1 series	Chemifit C1S series	Chemifit CP series	PushOne A series	PushOne A series Mini type	PushOne E series	PushOne E series Brass body type	QuickSeal series Insertion type (brass)

Applicable fittings



Related products and product introduction

Chemifit C1 Speed controller	Various bending processing	Flexible fluorocarbon resin bilayer tubing

Reference

Chemical resistance specification tableP.198
 Effective sectional area ...P.168
 Negative-pressure performance listP.169

(*1) Combinatory use of TP tubing and PushOne series / QuickSeal series mixes general and clean type performances.

When using them together in a clean environment, be aware of how this could lower the cleanliness level.

(*2) Contact us for specifications.

Polyurethane Coil Tubing

UC/USC/UMC

Features

- Polyurethane tubes of type U2 in coiled form.
- USC has a smaller coil diameter than UC.
- UMC is a coil tubing with multiple tubes welded for multi piping.

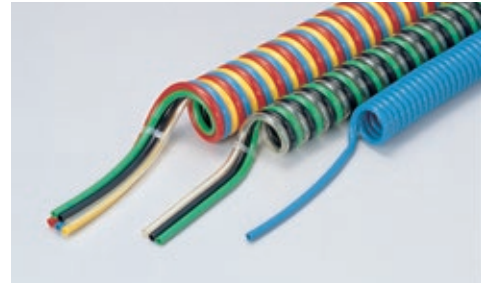

Standard products

UC

Product number	Outer diameter × Inner diameter (mm)	Coil size (mm)			Max. working pressure (MPa at 20°C)	Max. stretchable length (m)	Weight (g/m)	Coiling direction	Standard color Blue
		A	B	C					
UC-6	6×4	240		35	0.8	2.5	80	Right	●
UC-8	8×5	300	200	42					
UC-10	10×6.5			52					

☞ Other tubing colors are available on request.

USC (small coil diameter type)

Product number	Outer diameter × Inner diameter (mm)	Coil size (mm)			Max. working pressure (MPa at 20°C)	Max. stretchable length (m)	Weight (g/m)	Coiling direction	Standard color Blue
		A	B	C					
USC-4	4×2.5	230		18	0.8	1.5	24	Left	●
USC-6	6×4	360	100	24					
USC-8	8×5			31					
USC-10	10×6.5			40					

☞ Other tubing colors are available on request.

UMC (multi-coil type)

Product number	Number of tubes	Outer diameter × Inner diameter (mm)	Coil size (mm)			Max. working pressure (MPa at 20°C)	Max. stretchable length (m)	Weight (g/m)	Standard color combination	
			A	B	C					
UMC602	A B	6×4	350	100	40	0.8	1.5	114	●●	
UMC603	A B								3	●●●
UMC604	A B								4	●●●●
UMC606	A B	8×5	350	100	49	0.8	1.0	270	●●●●	
UMC802	A B								2	●●●●●
UMC803	A B								3	●●●●●●

☞ Other tubing colors are available on request.

Nominal lengths

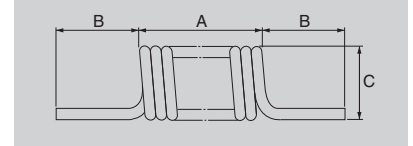

A: Total length of coiled part

B: Length of straight part

C: Outer coil diameter

Operating fluid, working temperature range

Operating fluid	Working temperature range
Air	-40°C~+80°C

Negative pressure performance

-101.294kPa

Relation between the working temperature and the maximum working pressure

The maximum working pressure varies with the working temperature (environmental temperature). For use at an abnormal temperature, always check the maximum working pressure change in the graph below and keep the pressure within the indicated range.

⚠ Caution: Using tubes at a pressure outside the range may cause accidents or damage, for which Nitta is not liable.

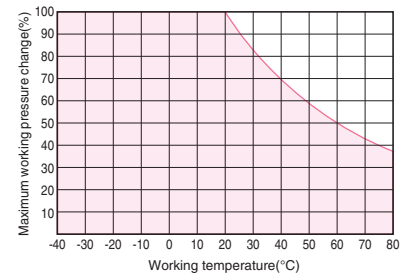

☞ See page 10 for common instructions for tubing products.

Applicable fittings



(*1) Combinatory use of polyurethane coil tubing and Chemifit series mixes general and clean type performances. When using them together in a clean environment, be aware of how this could lower the cleanliness level.

Related products and product introduction

Tool balancer



Tubing
Clean tubing
Processed tubing
PushOne fitting
QuickSeal fitting
Clean fitting/Chemifit
Bamboo-shoot fitting
Control switch/Detachable series
Jig/Tool/Accessory
Technical information
Reference

Polyurethane Multi-line Tubing

UML

Features

- Multiple Polyurethane tubes of type U2 are welded together.



Product number table

● Millimeter size type

Product number	Outer diameter × Inner diameter (mm)	Max. working pressure (MPa at 20°C)	Min. bending radius	Weight (g/m)	Standard color combination		
UML-402	4×2.5	0.8	10	18	●●		
UML-403				27	●●●		
UML-404				36	●●●●		
UML-406				54	●●●●●		
UML-602				6×4	15	38	●●
UML-603						57	●●●
UML-604	25		76			●●●●	
UML-606			114			●●●●●	
UML-802	8×5		23			70	●●
UML-803							105

Standard length

5M

Applicable fittings

QuickSeal series
Insertion type (brass)



QuickSeal series
Insertion type (stainless)



Chemifit CSE series



(*1) Combinatory use of polyurethane multiline tubing and Chemifit series mixes general and clean type performances. When using them together in a clean environment, be aware of how this could lower the cleanliness level.

Operating fluid, working temperature range

Operating fluid	Working temperature range
Air	-40°C~+80°C

Negative pressure performance

-101.294kPa

Relation between the working temperature and the maximum working pressure

The maximum working pressure varies with the working temperature (environmental temperature). For use at an abnormal temperature, always check the maximum working pressure change in the graph below and keep the pressure within the indicated range.

⚠ Caution: Using tubes at a pressure outside the range may cause accidents or damage, for which Nitta is not liable.

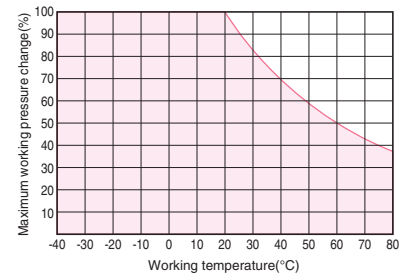

➔ See page 10 for common instructions for tubing products.

Tubing

Clean tubing

Processed tubing

PushOne fitting

QuickSeal fitting

Clean fitting/ Chemifit

Bamboo-shoot fitting

Control switch/ Detachable series

Jig/Tool/ Accessory

Technical information

Reference

Nylon Coil Tubing

S

Features

- Coil tubing with strong elasticity easily returns from stretched form.
- High pressure resistance and heat resistance.



Nylon coil tubing with dedicated fittings attached

Standard products

Original length of tubing is 30M before being coiled.

Product number	Outer diameter x Inner diameter (mm)	Max. working pressure (MPa at 20°C)	Length of coil part	Max. stretchable length (mm)	Outer coil diameter (mm)	Weight (g/m)	Standard color (color symbol) Orange(OR)
S3/16-OR-30M	5.95x4.76	1.2	1170	21	55	0.38	●
S1/4-OR-30M	7.85x6.35		1120	20	75	0.60	●
S3/8-OR-30M	11.80x9.53		1210	19	105	1.25	●
S1/2-OR-30M	15.87x12.70		1090	18	155	2.55	●
S3/4-OR-30M	22.80x19.05		690	19.5	360	3.80	●

Product number example

S1/4-OR-30M

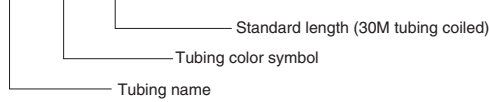

Applicable fittings

QuickSeal series Nylon coil tubing dedicated type



Related products and product introduction

Q.D.C. 101 series



Operating fluid, working temperature range

Operating fluid	Working temperature range
Air	-40°C~+100°C

Negative pressure performance

-101.294kPa

Relation between the working temperature and the maximum working pressure

The maximum working pressure varies with the working temperature (environmental temperature). For use at an abnormal temperature, always check the maximum working pressure change in the graph below and keep the pressure within the indicated range.

⚠ Caution: Using tubes at a pressure outside the range may cause accidents or damage, for which Nitta is not liable.

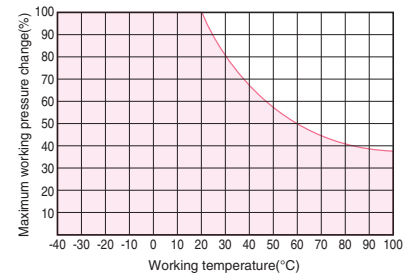

👉 See page 10 for common instructions for tubing products.

Tubing
Clean tubing
Processed tubing
PushOne fitting
QuickSeal fitting
Clean fitting/Chemifit
Bamboo-shoot fitting
Control switch/Detachable series
Jig/Tool/Accessory
Technical information
Reference

Multi-pack Tubing

1213

(Made to order)

Features

- Processed tubing for multi piping of up to 19 nylon tubes (N2 tubes) of $\phi 6$ bundled together.

Structure diagram

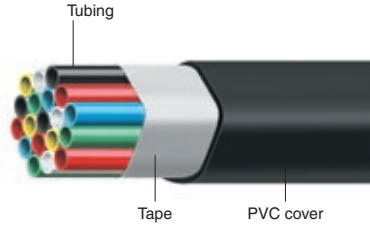

Product number table (Made to order)

- N2-4-6x4 (Color: Choose from standard colors of N2 tubing)

Product number	Number of tubes	Max. outer diameter (mm)	Cover thickness (mm)	Max. working pressure (MPa at 20°C)	Min. bending radius (mm)	Max. allowable tensile strength (N)	Max. bundle sectional area (mm ²)	Weight (g/m)
1213-0602	2	16	1.6	3.0	40	400	122	130
1213-0603	3	16			40	500	165	173
1213-0604	4	20			60	600	208	194
1213-0605	5	22			60	750	251	230
1213-0607	7	22			75	850	326	267
1213-0608	8	25			95	1050	369	298
1213-0610	10	28			100	1150	443	348
1213-0612	12	28			110	1350	518	390
1213-0614	14	31			130	1500	592	443
1213-0619	19	34	150	1900	765	567		

Minimum length for order

95M



Operating fluid, working temperature range

Operating fluid	Working temperature range
Air	-40°C~+100°C

Negative pressure performance

-101.294kPa

Relation between the working temperature and the maximum working pressure

The maximum working pressure varies with the working temperature (environmental temperature). For use at an abnormal temperature, always check the maximum working pressure change in the graph below and keep the pressure within the indicated range.

⚠ Caution: Using tubes at a pressure outside the range may cause accidents or damage, for which Nitta is not liable.

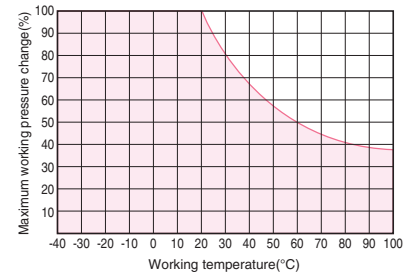

👉 See page 10 for common instructions for tubing products.

Applicable fittings



Tubing

Clean tubing

Processed tubing

PushOne fitting

QuickSeal fitting

Clean fitting/Chemifit

Bamboo-shoot fitting

Control switch/Detachable series

Jig/Tool/Accessory

Technical information

Reference

FITTING FITTING

Handling instructions for fitting products

⚠ Safety Note

This Safety Note provides indications on the correct use of the product in order to prevent harm to people and property. The indications are classified into three categories, "danger", "warning", and "caution", depending on the level of potential harm due to improper use. Each category contains important instructions on safety that should be followed in addition to the latest ISO 4414(*1), JIS B 8370(*2), ISO 4413 (*3), and JIS B 8361 (*4).

(*1) ISO 4414 Pneumatic fluid power...Recommendations for the application of equipment to transmission and control systems.

(*2) JIS B 8370 Pneumatic System General Rules

(*3) ISO 4413 Hydraulic fluid power...General rules for the application of equipment to transmission and control systems.

(*4) JIS B 8361 Hydraulic System General Rules

⚠ DANGER

Where inappropriate use of this equipment may cause death or severe injury and where immediate warning of a dangerous situation is mandated.

⚠ WARNING

Where inappropriate use of this equipment may cause death or severe injury.

⚠ CAUTION

Where inappropriate use of this equipment may cause minor injury.

⚠ Before Selection

⚠ DANGER

•Cannot use for machines or equipment for life support.

•To use for machines or equipment that require extremely high safety, measures have to be taken to prevent danger in the event tubing pulls out, bursts or leaks.

⚠ WARNING

•Please contact us before using our products under conditions other than those specified in the catalog.

•Please contact us when using our products for equipment, machines, various types of vehicles, and passenger aircraft, for leisure machines or passenger transport, for medical equipment that would cause human harm in case the specifications are not properly followed, and for machines in contact with food or drinking water.

⚠ When Selecting

⚠ WARNING

•Please check that our products are used under the "use conditions" specified in the catalog.

•Do not use our products when a caustic or flammable gas is used as the fluid or is in the environment.

⚠ CAUTION

•Do not use our products in places where excessive vibration or impact may occur.

•If use conditions differ between tubing and fittings, use them under the lower specified conditions.

•For Nitta's fitting products, use tubing products that Nitta specifies or JIS B 8381-1995 on-spec products.

•When a chemical is used in fluid or the environment, see "Chemical resistance specification table". Contact us for chemical resistance of plating.

•When spatter (hot wasted metal) is likely to cling to fittings, use flame-resistant products only. Otherwise spatter may cause fire.

•The maximum operating pressure varies for Chemifit C1 series, Chemifit C1S series and Chemifit CP series depending on the operating temperature. See "Relation between the working temperature and the maximum working pressure" when selecting.

⚠ Installation

⚠ WARNING

•Fix tubes in place when installing them in a situation where unexpected disconnection of the tubing and connector could cause harm to people or property.

⚠ CAUTION

•Instruction for connecting fittings provide in a separate document. Please read it and follow the instructions to install.

•Do not throw or drop fittings. The impact may cause internal damage even if no outer damage is found.

•Because the connection part of the fitting may swell or crack depending on the material, check the strength of the part when connecting.

•Fittings with a sealing processed thread may swell due to the action of an operating fluid such as organic solvent, allowing fluid leakage from the thread part.

•Avoid sharply bending the piping near the tubing insertion port of fittings. Keep the tubing straight for twice as long as the tubing diameter from the insertion port.

•Do not use a fitting with a damaged thread or a damaged tubing insertion port. Before using re-usable products, always check that they are undamaged.

•Nitta only guarantees products fabricated by designated companies.

•Please do not install with tension applied on the tubing or a torsional or bending load applied on the fittings.

•When using water as the operating fluid for PushOne series, Chemifit C1 series and Chemifit C1S series, avoid installing to a place where assembly could be moved.

•You cannot re-use sleeves of the QuickSeal series. Replace them with new sleeves each time you detach.

•You cannot re-use the sleeve and the nut of the Chemifit CP series. Replace them with a new sleeve each time you detach.

•Please do not use the product in an environment where foreign materials may enter the product or come into contact with its internal parts. Doing so may result in damage or leakage.

•Please do not use the products in a manner where the screw side or the tubing insertion opening side is rotated or oscillated repeatedly.

⚠ Usage

⚠ WARNING

•Nitta's products should be handled only by designers who have sufficient knowledge of equipment, instruments and systems in which our products are to be installed, or by persons responsible for determining specifications. Test and analysis should be conducted if necessary. The designers or the responsible persons are liable for the performance and the safety of the equipment, instruments and systems.

⚠ CAUTION

•When water is used as fluid, do not allow it to freeze.

•Do not touch a tubing at pressurization. Improperly treating or touching a tubing at pressurization may lead to danger from unexpected breakage or leakage of fluid.

•Do not touch a tubing when the operating fluid is hot. Doing so may cause burns.

⚠ Storage

⚠ CAUTION

•When storing unused products, make sure to keep them in a clean place to prevent dust. When fine particles such as dust enter the inside of tubing products or the connected equipment, they may cause problems.

•Keep tubing products in a dry place below 40°C avoiding direct sunlight.

•Do not use tubing products that have been stored for more than one year after production.

•The packaging of clean tubes should be opened just before use. Store the tubes in a box in a clean place in a dust-free environment.

⚠ Maintenance and Inspection

⚠ CAUTION

•Before handling or removing Nitta's products, be sure to check the safety by shutting off power supply, stopping pressure supply, evacuating pressurized air in the pipe, and terminating the operation of equipment, instruments, and systems.

•Please be sure to make periodic inspections. Confirm that there is no degradation such as outer damage, corrosion, and abrasion and replace any damaged piping.

•When using QuickSeal and Chemifit CP series continuously for a long time, or when using them continuously at a high temperature within the working temperature range, tighten their nuts periodically. Also if using a fitting with a resin thread, tighten the thread periodically.

⚠ Disposal

⚠ CAUTION

•Dispose of unnecessary products as industrial waste or have them disposed of by a waste disposal firm. In particular, incineration of products containing fluorocarbon may generate a toxic pyrolysis gas.

FITTING INDEX

Tubing

Clean tubing

Processed tubing

PushOne fitting

QuickSeal fitting

Clean fitting/
Chemifit

Bamboo-shoot fitting

Control switch/
Detachable series

Jig/Tool/
Accessory

Technical information

Reference

PushOne™ A Series

For general air pressure



For general air pressure



PushOne™ E Series

For general air pressure



For general air pressure

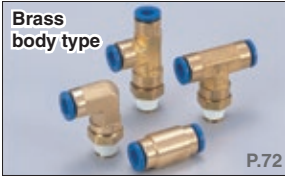

QuickSeal Series

For multi-purpose piping



For multi-purpose piping



For general air pressure



QuickSeal Series

For general air pressure



For general air pressure



Chemifit™ C1 Series

For clean air, pure water, chemical liquid piping



Chemifit™ C1S Series

For clean air, pure water, chemical liquid piping



Chemifit™ CSE Series

For clean air, pure water, chemical liquid piping



Chemifit™ CP Series

For clean air, pure water, chemical liquid piping



Bamboo-shoot Series

Bamboo-shoot fitting



PushOne™ A Series

PushOne™ fittings for general air pressure (flame-resistant)

Features

- **PushOne™ connection of tubing**
The tubes can be connected without using a jig or tools.
- **Electroless nickel plated**
Prevents degradation of surface and dissolution of copper ions in fluid.
- **White body illuminative to working environment**
- **Flame-resistant resin (compliant with V-0 of UL94 standard)**
Made of flame-resistant resin PBT. High self-extinguishing performance is compliant with V-0 of UL94 standard. Usable under an environment with spatters.
- **Sealing-processed R thread**
Sealing tape is not required.



Cross-sectional structure diagram

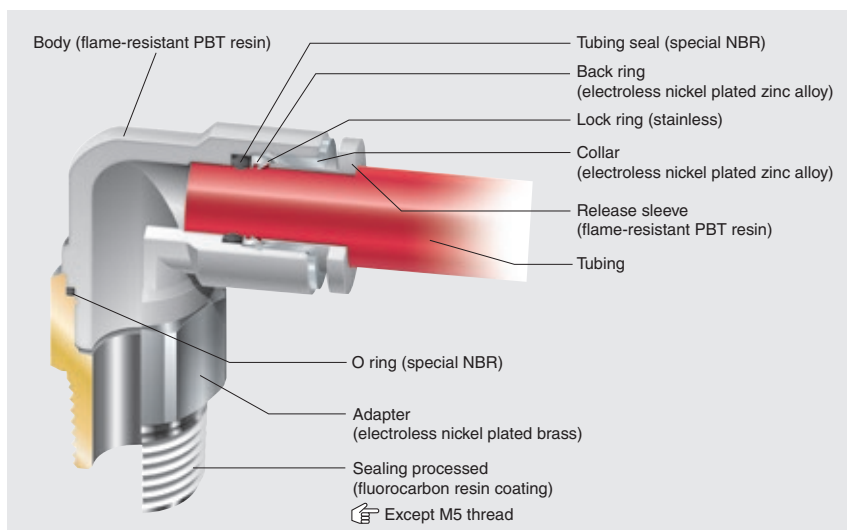

Operating fluid, working temperature range

Operating fluid	Working temperature range
Air	-20°C~+80°C
Water	0°C~+40°C

See "Combination List of Tubing and Fitting" on page 8.

Pressure condition

Maximum working pressure: 1.0MPa
Negative pressure performance: -99.975kPa

Handling instructions

- ⚠ Caution: When the working conditions of tubes and fittings differ, use them under the lower specified conditions.
- ⚠ Caution: When water is used as the operating fluid, confirm that there is no water leakage damage to equipment and instruments due to construction failure.
- ⚠ Caution: When water is used as the operating fluid, do not allow it to freeze.
- ⚠ Caution: Do not bend the pipe sharply near the tubing insertion port of the fitting. Keep the tubing straight for twice as long as the tubing diameter from the insertion port.

See page 34 for the common handling instructions for fittings.

Product number example

AL 6 - R1/8



Applicable tubing

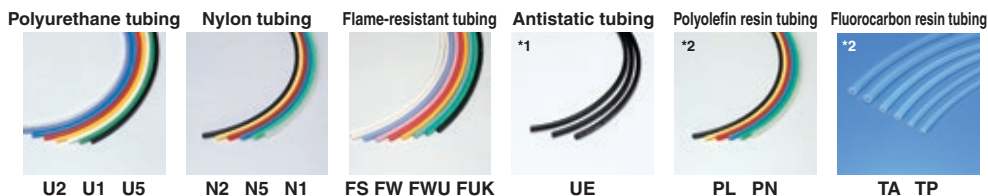

(*1) When the PushOne A series is used with a UE tubing, choose a metal body type including a connector and a hexagonal socket to maintain conductivity between the tubing and the fittings.

(*2) Combinatory use of PL, PN, TA or TP tubing and PushOne A series mixes general and clean type performances. When using them together in a clean environment, be aware of how this could lower the cleanliness level.

Related products and product introduction

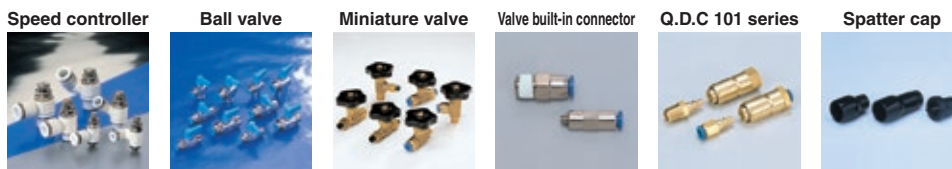

Reference

Instruction manualP.170
UL-94 standard flame testP.195
Effective sectional area ..P.168
Negative-pressure performance listP.169

PushOne™ A Series

Shape list



Tubing

Clean tubing

Processed tubing

PushOne fitting

QuickSeal fitting

Clean fitting/
Chemifit

Bamboo-shoot fitting

Control switch/
Detachable series

Jig/Tool/
Accessory

Technical information

Reference

Connector

●Millimeter size type

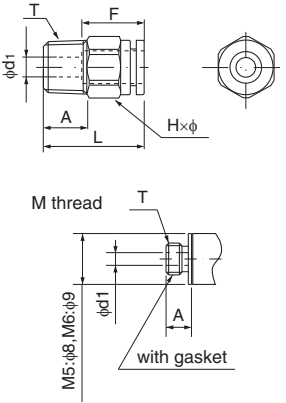

Product number	Applicable tubing outer diameter (mm)	T Thread size (M,R)	L (mm)	A (mm)	F Tubing insertion length (mm)	H×φ Width across flat (mm)	d ₁ (mm)	Effective sectional area (mm ²)	Weight (g)
AC4-M5	4	M5×0.8	22.4	4.0	13	10.0×11.0	2.0	3.0	6.0
AC4-R1/8	4	R1/8	19.4	8.0	13	10.0×11.0	2.5	4.0	7.0
AC4-R1/4	4	R1/4	22.4	11.0	13	14.0×15.4	2.5	4.0	17.0
AC6-M5	6	M5×0.8	24.2	4.0	15	12.0×13.0	2.0	3.5	9.0
AC6-M6	6	M6×1.0	25.2	5.0	15	12.0×13.0	3.0	4.5	10.0
AC6-R1/8	6	R1/8	21.2	8.0	15	12.0×13.0	4.0	10.5	9.0
AC6-R1/4	6	R1/4	24.2	11.0	15	14.0×15.4	4.0	10.5	18.0
AC6-R3/8	6	R3/8	25.2	12.0	15	17.0×18.5	4.0	10.5	32.0
AC8-R1/8	8	R1/8	26.2	8.0	16	14.0×15.4	5.0	20.0	14.0
AC8-R1/4	8	R1/4	25.2	11.0	16	14.0×15.4	6.0	25.0	16.0
AC8-R3/8	8	R3/8	26.2	12.0	16	17.0×18.5	6.0	26.0	29.0
AC10-R1/8	10	R1/8	30.1	8.0	19	17.0×18.5	5.0	25.0	24.0
AC10-R1/4	10	R1/4	28.1	11.0	19	17.0×18.5	8.0	40.0	21.0
AC10-R3/8	10	R3/8	29.1	12.0	19	17.0×18.5	8.0	40.0	29.0
AC10-R1/2	10	R1/2	32.1	15.0	19	22.0×24.5	8.0	40.0	61.0
AC12-R1/4	12	R1/4	34.0	11.0	20	19.0×21.0	8.0	45.0	32.0
AC12-R3/8	12	R3/8	30.0	12.0	20	19.0×21.0	10.0	50.0	31.0
AC12-R1/2	12	R1/2	33.0	15.0	20	22.0×24.5	10.0	50.0	58.0
AC16-R3/8	16	R3/8	41.6	12.0	27	24.0×26.5	10.0	77.0	68.0
AC16-R1/2	16	R1/2	43.6	15.0	27	24.0×26.5	12.0	110.5	83.0

*Made to order

Hexagon socket connector

●Millimeter size type

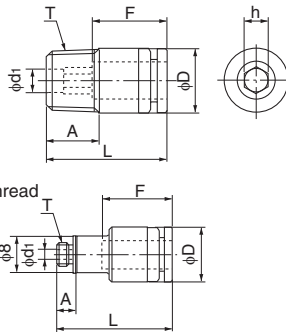

Product number	Applicable tubing outer diameter (mm)	T Thread size (M,R)	L (mm)	A (mm)	F Tubing insertion length (mm)	h Width across flat (mm)	D (mm)	d ₁ (mm)	Effective sectional area (mm ²)	Weight (g)
AC4-M5A	4	M5×0.8	19.4	4.0	13	2.0	9.8	2.0	—	5.0
AC4-R1/8A	4	R1/8	19.4	8.0	13	2.5	9.8	2.5	—	7.0
AC6-M5A	6	M5×0.8	24.2	4.0	15	4.0	11.8	2.0	—	18.0
AC6-R1/8A	6	R1/8	21.2	8.0	15	4.0	11.8	4.0	—	8.0
AC6-R1/4A	6	R1/4	24.2	11.0	15	4.0	13.8	4.0	—	17.0
AC8-R1/8A	8	R1/8	26.2	8.0	16	5.0	13.8	5.0	—	12.0
AC8-R1/4A	8	R1/4	25.2	11.0	16	5.0	13.8	5.0	—	15.0
AC10-R1/4A	10	R1/4	28.1	11.0	19	6.0	16.8	6.0	—	19.0
AC10-R3/8A	10	R3/8	29.1	12.0	19	6.0	16.8	6.0	—	28.0

Internal connector

●Millimeter size type

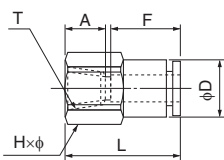

Product number	Applicable tubing outer diameter (mm)	T Thread size (RC)	L (mm)	A (mm)	F Tubing insertion length (mm)	H×φ Width across flat (mm)	D (mm)	Min. inner diameter (mm)	Effective sectional area (mm ²)	Weight (g)
AFC4-R1/8	4	RC1/8	23.9	8.7	13	14.0×15.4	10.0	3.0	4.0	16.0
AFC6-R1/8	6	RC1/8	24.8	8.7	15	14.0×15.4	12.0	5.0	10.5	17.0
AFC6-R1/4	6	RC1/4	29.3	13.0	15	17.0×18.5	12.0	5.0	10.5	26.0
AFC8-R1/4	8	RC1/4	30.9	13.0	16	17.0×18.5	13.9	7.0	25.0	28.0
AFC8-R3/8	8	RC3/8	31.4	13.5	16	22.0×24.5	13.9	7.0	26.0	45.0
AFC10-R1/4	10	RC1/4	33.9	13.0	19	17.0×18.5	16.9	9.0	40.0	34.0
AFC10-R3/8	10	RC3/8	34.4	13.5	19	22.0×24.5	16.9	9.0	40.0	50.0
AFC10-R1/2	10	RC1/2	38.4	17.5	19	24.0×26.5	16.9	9.0	40.0	56.0
AFC12-R1/4	12	RC1/4	34.8	13.0	20	19.0×21.0	19.0	10.0	45.0	43.0
AFC12-R3/8	12	RC3/8	35.3	13.5	20	22.0×24.5	19.0	11.0	50.0	50.0
AFC12-R1/2	12	RC1/2	39.3	17.5	20	24.0×26.5	19.0	11.0	50.0	58.0

Tubing

Clean tubing

Processed tubing

PushOne fitting

QuickSeal fitting

Clean fitting/ Chemifit

Bamboo-shoot fitting

Control switch/ Detachable series

Jig/Tool/ Accessory

Technical information

Reference

90 degree elbow

●Millimeter size type

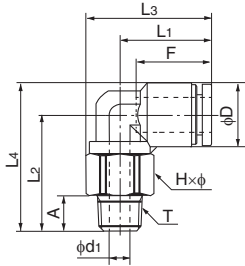

M thread

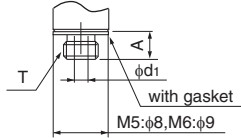

Product number	Applicable tubing outer diameter (mm)	T Thread size (M,R)	L1 (mm)	L2 (mm)	L3 (mm)	L4 (mm)	A (mm)	F Tubing insertion length (mm)	H×φ Width across flat (mm)	D (mm)	d1 (mm)	Min. inner diameter (mm)	Effective sectional area (mm ²)	Weight (g)
AL4-M5-Z2	4	M5×0.8	17.2	18.3	22.7	23.2	4.0	13	10.0×11.0	9.8	2.0	2.0	3.0	6.0
AL4-R1/8-Z2	4	R1/8	17.2	22.7	22.7	27.6	8.0	13	10.0×11.0	9.8	5.0	3.0	4.0	10.0
AL4-R1/4-Z2	4	R1/4	17.2	24.4	24.9	29.3	12.0	13	14.0×15.4	9.8	5.0	3.0	4.0	19.0
AL6-M5-Z2	6	M5×0.8	18.5	22.2	25.0	28.5	4.0	15	12.0×13.0	12.6	2.0	2.0	3.5	10.0
AL6-M6	6	M6×1.0	18.5	22.7	25.0	29.0	5.0	15	12.0×13.0	12.6	3.0	3.0	4.5	11.0
AL6-R1/8-Z2	6	R1/8	18.5	25.2	25.0	31.5	8.0	15	12.0×13.0	12.6	5.0	5.0	12.0	12.0
AL6-R1/4-Z2	6	R1/4	18.5	25.8	26.2	32.1	12.0	15	14.0×15.4	12.6	7.0	5.0	12.0	17.0
AL6-R3/8-Z2	6	R3/8	18.5	26.8	27.8	33.1	12.0	15	17.0×18.5	12.6	11.0	5.0	12.0	27.0
AL8-R1/8-Z2	8	R1/8	20.7	26.2	28.4	33.5	8.0	16	14.0×15.4	14.6	5.0	5.0	18.5	16.0
AL8-R1/4-Z2	8	R1/4	20.7	30.2	28.4	37.5	12.0	16	14.0×15.4	14.6	8.0	7.0	23.0	19.0
AL8-R3/8-Z2	8	R3/8	20.7	27.8	30.0	35.1	12.0	16	17.0×18.5	14.6	9.0	7.0	23.0	28.0
AL10-R1/8-Z2	10	R1/8	24.7	29.2	33.9	38.0	8.0	19	17.0×18.5	17.5	5.0	5.0	22.0	23.0
AL10-R1/4-Z2	10	R1/4	24.7	32.4	33.9	41.1	12.0	19	17.0×18.5	17.5	8.0	8.0	38.0	25.0
AL10-R3/8-Z2	10	R3/8	24.7	34.2	33.9	43.0	12.0	19	17.0×18.5	17.5	11.0	9.0	37.0	30.0
AL10-R1/2-Z2	10	R1/2	24.7	34.3	36.9	43.0	16.0	19	22.0×24.5	17.5	12.0	9.0	37.0	53.0
AL12-R1/4-Z2	12	R1/4	26.3	35.0	36.8	45.0	12.0	20	19.0×21.0	20.0	8.0	8.0	42.0	31.0
AL12-R3/8-Z2	12	R3/8	26.3	33.5	36.8	43.5	12.0	20	19.0×21.0	20.0	11.0	11.0	46.0	32.0
AL12-R1/2-Z2	12	R1/2	26.3	36.5	38.6	46.5	16.0	20	22.0×24.5	20.0	12.0	11.0	46.0	53.0
AL16-R3/8	16	R3/8	34.9	45.0	48.4	59.0	12.0	27	24.0×27.0	28.0	11.0	11.0	70.0	70.0
AL16-R1/2	16	R1/2	34.9	48.0	48.4	62.0	15.0	27	24.0×27.0	28.0	12.0	12.0	93.0	84.0

*Made to order

90 degree internal elbow

●Millimeter size type

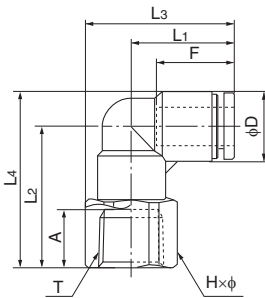

Product number	Applicable tubing outer diameter (mm)	T Thread size (RC)	L1 (mm)	L2 (mm)	L3 (mm)	L4 (mm)	A (mm)	F Tubing insertion length (mm)	H×φ Width across flat (mm)	D (mm)	Min. inner diameter (mm)	Effective sectional area (mm ²)	Weight (g)
AFL4-R1/8	4	RC1/8	17.2	21.7	24.9	26.6	8.0	13	14.0×15.4	9.8	3.0	—	13.0
AFL6-R1/8	6	RC1/8	18.5	24.2	26.2	30.5	8.0	15	14.0×15.4	12.6	5.0	—	15.0
AFL6-R1/4	6	RC1/4	18.5	28.2	27.8	34.5	12.0	15	17.0×18.5	12.6	5.0	—	23.0
AFL6-R3/8	6	RC3/8	18.5	28.7	30.8	35.0	12.5	15	22.0×24.5	12.6	5.0	—	37.0
AFL8-R1/8	8	RC1/8	20.7	25.2	28.4	32.5	8.0	16	14.0×15.4	14.6	7.0	—	17.0
AFL8-R1/4	8	RC1/4	20.7	29.2	30.0	36.5	12.0	16	17.0×18.5	14.6	7.0	—	25.0
AFL8-R3/8	8	RC3/8	20.7	29.7	33.0	37.0	12.5	16	22.0×24.5	14.6	7.0	—	38.0
AFL10-R1/4	10	RC1/4	24.7	32.2	33.9	41.0	12.0	19	17.0×18.5	17.5	9.0	—	29.0
AFL10-R3/8	10	RC3/8	24.7	33.7	36.9	42.5	12.5	19	22.0×24.5	17.5	9.0	—	45.0
AFL12-R3/8	12	RC3/8	26.3	36.2	38.6	46.2	12.5	20	22.0×24.5	20.0	10.0	—	49.0
AFL12-R1/2	12	RC1/2	26.3	39.2	39.6	49.2	15.5	20	24.0×26.5	20.0	10.0	—	54.0

Tubing

Clean tubing

Processed tubing

PushOne fitting

QuickSeal fitting

Clean fitting/Chemifit

Bamboo-shoot fitting

Control switch/Detachable series

Jig/Tool/Accessory

Technical information

Reference

90 degree long elbow

●Millimeter size type

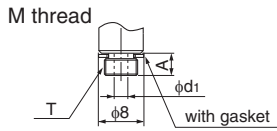
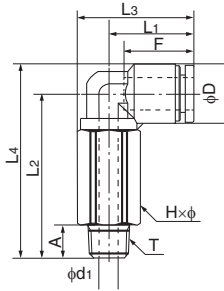

Product number	Applicable tubing outer diameter (mm)	T Thread size (M,R)	L ₁ (mm)	L ₂ (mm)	L ₃ (mm)	L ₄ (mm)	A (mm)	F Tubing insertion length (mm)	H×φ Width across flat (mm)	D (mm)	d ₁ (mm)	Min. inner diameter (mm)	Effective sectional area (mm ²)	Weight (g)
ALL4-M5-Z2	4	M5×0.8	17.2	29.9	22.7	34.8	4.0	13	10.0×11.0	9.8	2.0	2.0	3.0	14.0
ALL4-R1/8-Z2	4	R1/8	17.2	32.4	22.7	37.3	8.0	13	10.0×11.0	9.8	5.0	3.0	4.0	15.0
ALL4-R1/4-Z2	4	R1/4	17.2	36.4	24.9	41.3	12.0	13	14.0×15.4	9.8	5.0	3.0	4.0	34.0
ALL6-M5-Z2	6	M5×0.8	18.5	34.7	25.0	41.0	4.0	15	12.0×13.0	12.6	2.0	2.0	3.5	23.0
ALL6-R1/8-Z2	6	R1/8	18.5	37.2	25.0	43.5	8.0	15	12.0×13.0	12.6	5.0	5.0	12.0	23.0
ALL6-R1/4-Z2	6	R1/4	18.5	41.2	26.2	47.5	12.0	15	14.0×15.4	12.6	7.0	5.0	12.0	34.0
ALL6-R3/8-Z2	6	R3/8	18.5	42.2	27.8	48.5	12.0	15	17.0×18.5	12.6	11.0	5.0	12.0	54.0
ALL8-R1/8-Z2	8	R1/8	20.7	40.2	28.4	47.5	8.0	16	14.0×15.4	14.6	5.0	5.0	18.5	33.0
ALL8-R1/4-Z2	8	R1/4	20.7	44.2	28.4	51.5	12.0	16	14.0×15.4	14.6	8.0	7.0	23.0	33.0
ALL8-R3/8-Z2	8	R3/8	20.7	45.2	30.0	52.5	12.0	16	17.0×18.5	14.6	9.0	7.0	23.0	55.0
ALL10-R1/8-Z2	10	R1/8	24.7	46.2	33.9	55.0	8.0	19	17.0×18.5	17.5	5.0	5.0	22.0	55.0
ALL10-R1/4-Z2	10	R1/4	24.7	50.2	33.9	59.0	12.0	19	17.0×18.5	17.5	8.0	8.0	38.0	55.0
ALL10-R3/8-Z2	10	R3/8	24.7	51.2	33.9	60.0	12.0	19	17.0×18.5	17.5	11.0	9.0	37.0	52.0
ALL10-R1/2-Z2	10	R1/2	24.7	55.2	36.9	64.0	16.0	19	22.0×24.5	17.5	12.0	9.0	37.0	106.0
ALL12-R1/4-Z2	12	R1/4	26.3	55.2	36.8	65.2	12.0	20	19.0×21.0	20.0	8.0	8.0	42.0	75.0
ALL12-R3/8-Z2	12	R3/8	26.3	56.2	36.8	66.2	12.0	20	19.0×21.0	20.0	11.0	11.0	46.0	73.0
ALL12-R1/2-Z2	12	R1/2	26.3	60.2	38.6	70.2	16.0	20	22.0×24.5	20.0	12.0	11.0	46.0	114.0

45 degree elbow

●Millimeter size type

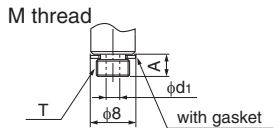
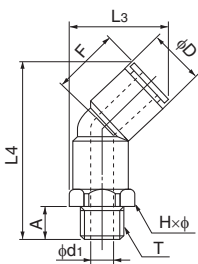

Product number	Applicable tubing outer diameter (mm)	T Thread size (M,R)	L ₃ (mm)	L ₄ (mm)	A (mm)	F Tubing insertion length (mm)	H×φ Width across flat (mm)	D (mm)	d ₁ (mm)	Min. inner diameter (mm)	Effective sectional area (mm ²)	Weight (g)
A45L4-M5	4	M5×0.8	19.7	34.4	4.0	13	10.0×11.0	9.8	2.0	2.0	3.0	7.0
A45L4-R1/8	4	R1/8	19.7	36.9	8.0	13	10.0×11.0	9.8	5.0	3.0	4.0	9.0
A45L4-R1/4	4	R1/4	21.9	40.9	11.0	13	14.0×15.4	9.8	7.0	3.0	4.0	16.0
A45L6-M5	6	M5×0.8	22.4	38.6	4.0	15	12.0×13.0	12.6	2.0	2.0	3.5	10.0
A45L6-R1/8	6	R1/8	22.4	41.1	8.0	15	12.0×13.0	12.6	5.0	5.0	12.0	12.0
A45L6-R1/4	6	R1/4	23.6	45.1	11.0	15	14.0×15.4	12.6	7.0	5.0	12.0	18.0
A45L6-R3/8	6	R3/8	25.2	46.1	12.0	15	17.0×18.5	12.6	9.0	5.0	12.0	26.0
A45L8-R1/8	8	R1/8	25.5	44.0	8.0	16	14.0×15.4	14.6	5.0	5.0	18.5	15.0
A45L8-R1/4	8	R1/4	25.5	48.0	11.0	16	14.0×15.4	14.6	7.0	7.0	23.0	20.0
A45L8-R3/8	8	R3/8	27.0	49.0	12.0	16	17.0×18.5	14.6	9.0	7.0	23.0	28.0
A45L10-R1/8	10	R1/8	30.0	50.0	8.0	19	17.0×18.5	17.5	5.0	5.0	22.0	22.0
A45L10-R1/4	10	R1/4	30.0	54.0	11.0	19	17.0×18.5	17.5	7.0	7.0	34.5	27.0
A45L10-R3/8	10	R3/8	30.0	55.0	12.0	19	17.0×18.5	17.5	9.0	9.0	37.0	33.0
A45L10-R1/2	10	R1/2	33.0	59.0	15.0	19	22.0×24.5	17.5	12.0	9.0	38.5	52.0
A45L12-R1/4	12	R1/4	33.5	58.7	11.0	20	19.0×21.0	20.0	7.0	7.0	43.0	34.0
A45L12-R3/8	12	R3/8	33.5	59.7	12.0	20	19.0×21.0	20.0	9.0	9.0	47.0	40.0
A45L12-R1/2	12	R1/2	35.3	63.7	15.0	20	22.0×24.5	20.0	12.0	10.0	47.0	57.0

Tubing
Clean tubing
Processed tubing
PushOne fitting
QuickSeal fitting
Clean fitting/ Chemifit
Bamboo-shoot fitting
Control switch/ Detachable series
Jig/Tool/ Accessory
Technical information
Reference

Universal elbow

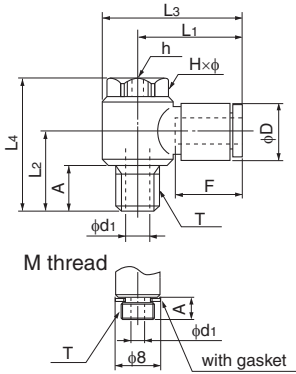

●Millimeter size type

Product number	Applicable tubing outer diameter (mm)	T Thread size (M,R)	L ₁ (mm)	L ₂ (mm)	L ₃ (mm)	L ₄ (mm)	A (mm)	F Tubing insertion length (mm)	H×φ Width across flat (mm)	h (mm)	D (mm)	d ₁ (mm)	Min. inner diameter (mm)	Effective sectional area (mm ²)	Weight (g)
ALB4-M5	4	M5×0.8	20.4	11.5	25.3	21.0	4.0	13	8.0×9.0	3.0	9.8	2.0	2.0	3.0	10.0
ALB4-R1/8	4	R1/8	23.4	17.5	30.4	30.0	9.5	13	13.0×14.0	5.0	9.8	5.0	3.0	4.0	20.0
ALB6-M5	6	M5×0.8	20.8	11.5	25.6	21.0	4.0	15	8.0×9.0	3.0	12.6	2.0	2.0	3.5	10.0
ALB6-R1/8	6	R1/8	22.8	17.5	29.8	30.0	9.5	15	13.0×14.0	5.0	12.6	5.0	3.2	8.0	21.0
ALB6-R1/4	6	R1/4	24.8	22.9	34.5	37.5	13.4	15	17.0×18.3	6.0	12.6	7.0	4.2	9.0	43.0
ALB8-R1/8	8	R1/8	24.4	17.5	31.4	30.0	9.5	16	13.0×14.0	5.0	14.6	5.0	3.2	9.0	41.0
ALB8-R1/4	8	R1/4	26.4	22.9	36.1	37.5	13.4	16	17.0×18.3	6.0	14.6	7.0	4.2	14.5	44.0
ALB8-R3/8	8	R3/8	28.4	24.4	40.4	40.5	13.9	16	21.0×22.6	8.0	14.6	9.0	6.0	19.0	69.0
ALB10-R1/4	10	R1/4	29.4	22.9	39.1	37.5	13.4	19	17.0×18.3	6.0	17.5	7.0	4.2	15.5	74.0
ALB10-R3/8	10	R3/8	31.4	24.4	43.4	40.5	13.9	19	21.0×22.6	8.0	17.5	9.0	6.0	23.0	74.0
ALB12-R3/8	12	R3/8	34.3	24.3	48.3	40.5	13.8	20	24.0×26.0	8.0	20.0	10.0	8.0	25.5	92.0
ALB12-R1/2	12	R1/2	34.3	27.3	48.3	43.5	16.8	20	24.0×26.0	8.0	20.0	12.0	8.0	25.5	100.0

90 degree branch elbow

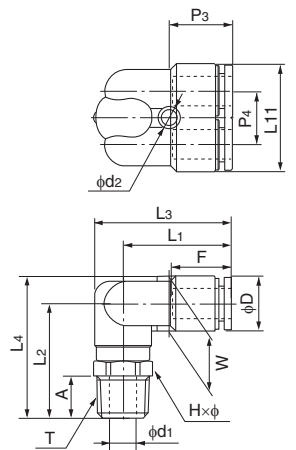

●Millimeter size type

Product number	Applicable tubing outer diameter (mm)	T Thread size (R)	L ₁ (mm)	L ₂ (mm)	L ₃ (mm)	L ₄ (mm)	L ₁₁ (mm)	A (mm)	F Tubing insertion length (mm)	H×φ Width across flat (mm)	P ₃ (mm)	P ₄ (mm)	W (mm)	D (mm)	d ₁ (mm)	d ₂ (mm)	Effective sectional area (mm ²)	Weight (g)
ALY6-R1/8	6	R1/8	25.6	25.2	32.1	31.5	24.8	8.0	15	12.0×13.0	14.8	12.2	12.6	12.6	5.0	4.2	—	16.0
ALY6-R1/4	6	R1/4	25.6	29.2	33.3	35.5	24.8	11.0	15	14.0×15.4	14.8	12.2	12.6	12.6	7.0	4.2	—	23.0
ALY8-R1/8	8	R1/8	28.2	26.2	35.9	33.5	28.8	8.0	16	14.0×15.4	16.4	14.2	14.6	14.6	5.0	4.2	—	21.0
ALY8-R1/4	8	R1/4	28.2	30.2	35.9	37.5	28.8	11.0	16	14.0×15.4	16.4	14.2	14.6	14.6	7.0	4.2	—	27.0
ALY8-R3/8	8	R3/8	28.2	31.2	37.5	38.5	28.8	12.0	16	17.0×18.5	16.4	14.2	14.6	14.6	9.0	4.2	—	35.0
ALY10-R1/4	10	R1/4	31.3	33.2	40.5	42.0	35.0	11.0	19	17.0×18.5	18.4	17.5	17.5	17.5	7.0	4.2	—	37.0
ALY10-R3/8	10	R3/8	31.3	34.2	40.5	43.0	35.0	12.0	19	17.0×18.5	18.4	17.5	17.5	17.5	9.0	4.2	—	43.0

Tubing

Clean tubing

Processed tubing

PushOne fitting

QuickSeal fitting

Clean fitting/ Chemifit

Bamboo-shoot fitting

Control switch/ Detachable series

Jig/Tool/ Accessory

Technical information

Reference

Universal branch elbow

●Millimeter size type



Product number	Applicable tubing outer diameter (mm)	T Thread size (R)	L ₁ (mm)	L ₂ (mm)	L ₃ (mm)	L ₄ (mm)	L ₁₁ (mm)	A (mm)	F Tubing insertion length (mm)	H×φ Width across flat (mm)	h Width across flat (mm)	P ₃ (mm)	P ₄ (mm)	W (mm)	D (mm)	d ₁ (mm)	d ₂ (mm)	Effective sectional area (mm ²)	Weight (g)
ALYB6-R1/8	6	R1/8	26.1	17.5	33.1	30.0	24.8	9.5	15	13.0×14.0	5.0	14.8	12.2	12.6	12.6	5.0	4.2	—	25.0
ALYB6-R1/4	6	R1/4	29.0	22.9	38.7	37.5	24.8	13.4	15	17.0×18.3	6.0	14.8	12.2	12.6	12.6	7.0	4.2	—	46.0
ALYB8-R1/4	8	R1/4	30.6	22.9	40.3	37.5	28.8	13.4	16	17.0×18.3	6.0	16.4	14.2	14.6	14.6	7.0	4.2	—	49.0
ALYB8-R3/8	8	R3/8	32.9	24.4	44.9	40.5	28.8	13.9	16	21.0×22.6	8.0	16.4	14.2	14.6	14.6	9.0	4.2	—	58.0
ALYB10-R1/4	10	R1/4	34.9	23.4	46.9	39.5	35.0	12.9	19	21.0×22.6	8.0	18.4	17.5	17.5	17.5	7.0	4.2	—	78.0
ALYB10-R3/8	10	R3/8	34.9	24.4	46.9	40.5	35.0	13.9	19	21.0×22.6	8.0	18.4	17.5	17.5	17.5	9.0	4.2	—	80.0

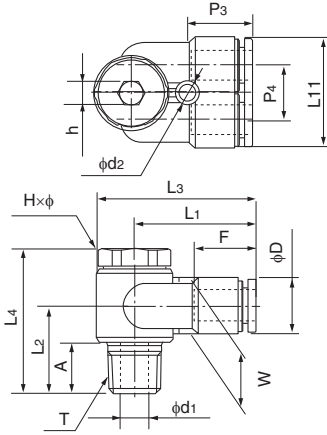

Double universal elbow

●Millimeter size type



Product number	Applicable tubing outer diameter (mm)	T Thread size (R)	L ₁ (mm)	L ₂ (mm)	L ₃ (mm)	L ₄ (mm)	L ₅ (mm)	A (mm)	F Tubing insertion length (mm)	H×φ Width across flat (mm)	D (mm)	d ₁ (mm)	Effective sectional area (mm ²)	Weight (g)
ALWB6-R1/8	6	R1/8	22.8	18.8	30.5	42.3	13.5	8.0	15	14.0×15.4	12.6	5.0	—	33.0
ALWB6-R1/4	6	R1/4	22.8	21.8	30.5	45.3	13.5	11.0	15	14.0×15.4	12.6	7.0	—	35.0
ALWB8-R1/4	8	R1/4	24.4	23.0	32.1	50.0	16.0	11.0	16	14.0×15.4	14.6	7.0	—	39.0
ALWB8-R3/8	8	R3/8	24.4	24.0	33.7	51.0	16.0	12.0	16	17.0×18.5	14.6	9.0	—	47.0
ALWB10-R1/4	10	R1/4	29.4	24.5	39.1	56.0	19.0	11.0	19	17.0×18.5	17.5	7.0	—	72.0
ALWB10-R3/8	10	R3/8	29.4	25.5	39.1	57.0	19.0	12.0	19	17.0×18.5	17.5	9.0	—	70.0

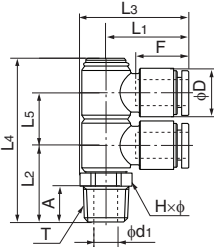

Triple universal elbow

●Millimeter size type



Product number	Applicable tubing outer diameter (mm)	T Thread size (R)	L ₁ (mm)	L ₂ (mm)	L ₃ (mm)	L ₄ (mm)	L ₅ (mm)	A (mm)	F Tubing insertion length (mm)	H×φ Width across flat (mm)	D (mm)	d ₁ (mm)	Effective sectional area (mm ²)	Weight (g)
ALTB6-R1/8	6	R1/8	22.8	18.8	30.5	55.5	13.5	8.0	15	14.0×15.4	12.6	5.0	—	43.0
ALTB6-R1/4	6	R1/4	22.8	21.8	30.5	58.5	13.5	11.0	15	14.0×15.4	12.6	7.0	—	45.0
ALTB8-R1/4	8	R1/4	24.4	23.0	32.1	66.0	16.0	11.0	16	14.0×15.4	14.6	7.0	—	51.0
ALTB8-R3/8	8	R3/8	24.4	24.0	33.7	67.0	16.0	12.0	16	17.0×18.5	14.6	9.0	—	59.0
ALTB10-R1/4	10	R1/4	29.4	24.5	39.1	75.5	19.0	11.0	19	17.0×18.5	17.5	7.0	—	98.0
ALTB10-R3/8	10	R3/8	29.4	25.5	39.1	76.5	19.0	12.0	19	17.0×18.5	17.5	9.0	—	92.0

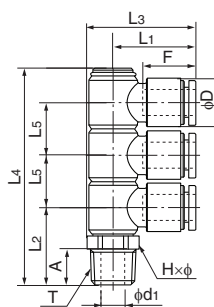

Tubing

Clean tubing

Processed tubing

PushOne fitting

QuickSeal fitting

Clean fitting/ Chemifit

Bamboo-shoot fitting

Control switch/ Detachable series

Jig/Tool/ Accessory

Technical information

Reference

Tee

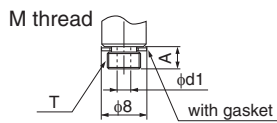
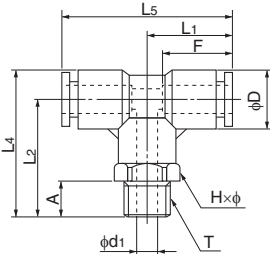

●Millimeter size type

Product number	Applicable tubing outer diameter (mm)	T Thread size (M,R)	L ₁ (mm)	L ₂ (mm)	L ₄ (mm)	L ₅ (mm)	A (mm)	F Tubing insertion length (mm)	H×φ Width across flat (mm)	D (mm)	d ₁ (mm)	Min. inner diameter (mm)	Effective sectional area (mm ²)	Weight (g)
AT4-M5	4	M5×0.8	17.2	20.2	25.1	34.4	4.0	13	10.0×11.0	9.8	2.0	2.0	3.0	8.0
AT4-R1/8	4	R1/8	17.2	22.7	27.6	34.4	8.0	13	10.0×11.0	9.8	5.0	3.0	4.0	10.0
AT4-R1/4	4	R1/4	17.2	26.7	31.6	34.4	11.0	13	14.0×15.4	9.8	7.0	3.0	4.0	17.0
AT6-M5	6	M5×0.8	18.5	22.7	29.0	37.0	4.0	15	12.0×13.0	12.6	2.0	2.0	3.5	12.0
AT6-R1/8	6	R1/8	18.5	25.2	31.5	37.0	8.0	15	12.0×13.0	12.6	5.0	4.6	12.0	14.0
AT6-R1/4	6	R1/4	18.5	29.2	35.5	37.0	11.0	15	14.0×15.4	12.6	7.0	4.6	12.0	21.0
AT6-R3/8	6	R3/8	18.5	30.2	36.5	37.0	12.0	15	17.0×18.5	12.6	9.0	4.6	12.0	29.0
AT8-R1/8	8	R1/8	20.7	26.2	33.5	41.4	8.0	16	14.0×15.4	14.6	5.0	5.0	18.5	18.0
AT8-R1/4	8	R1/4	20.7	30.2	37.5	41.4	11.0	16	14.0×15.4	14.6	7.0	7.0	23.0	24.0
AT8-R3/8	8	R3/8	20.7	31.2	38.5	41.4	12.0	16	17.0×18.5	14.6	9.0	7.0	23.0	32.0
AT10-R1/8	10	R1/8	24.7	29.2	38.0	49.3	8.0	19	17.0×18.5	17.5	5.0	5.0	22.0	28.0
AT10-R1/4	10	R1/4	24.7	33.2	42.0	49.3	11.0	19	17.0×18.5	17.5	7.0	7.0	34.5	34.0
AT10-R3/8	10	R3/8	24.7	34.2	43.0	49.3	12.0	19	17.0×18.5	17.5	9.0	9.0	37.0	39.0
AT10-R1/2	10	R1/2	24.7	38.2	47.0	49.3	15.0	19	22.0×24.5	17.5	12.0	9.0	37.0	58.0
AT12-R1/4	12	R1/4	26.3	35.7	45.7	52.6	11.0	20	19.0×21.0	20.0	7.0	7.0	36.0	43.0
AT12-R3/8	12	R3/8	26.3	36.7	46.7	52.6	12.0	20	19.0×21.0	20.0	9.0	9.0	43.0	48.0
AT12-R1/2	12	R1/2	26.3	40.7	50.7	52.6	15.0	20	22.0×24.5	20.0	12.0	10.0	43.0	65.0
AT16-R3/8	16	R3/8	34.9	45.0	59.0	69.8	12.0	27	24.0×27.0	28.0	11.0	11.0	70.0	92.0
AT16-R1/2	16	R1/2	34.9	48.0	62.0	69.8	15.0	27	24.0×27.0	28.0	12.0	12.0	93.0	106.0

Service tee

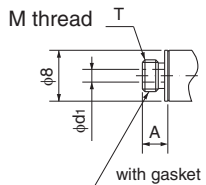
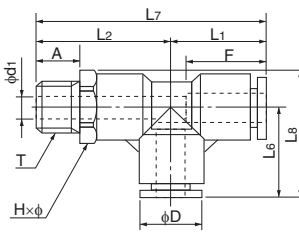

●Millimeter size type

Product number	Applicable tubing outer diameter (mm)	T Thread size (M,R)	L ₁ (mm)	L ₂ (mm)	L ₆ (mm)	L ₇ (mm)	L ₈ (mm)	A (mm)	F Tubing insertion length (mm)	H×φ Width across flat (mm)	D (mm)	d ₁ (mm)	Min. inner diameter (mm)	Effective sectional area (mm ²)	Weight (g)
AST4-M5	4	M5×0.8	17.2	20.2	17.2	37.4	22.7	4.0	13	10.0×11.0	9.8	2.0	2.0	3.0	8.0
AST4-R1/8	4	R1/8	17.2	22.7	17.2	39.9	22.7	8.0	13	10.0×11.0	9.8	5.0	3.0	4.0	10.0
AST4-R1/4	4	R1/4	17.2	26.7	17.2	43.9	24.9	11.0	13	14.0×15.4	9.8	7.0	3.0	4.0	18.0
AST6-M5	6	M5×0.8	18.5	22.7	18.5	41.2	25.0	4.0	15	12.0×13.0	12.6	2.0	2.0	3.5	12.0
AST6-R1/8	6	R1/8	18.5	25.2	18.5	43.7	25.0	8.0	15	12.0×13.0	12.6	5.0	5.0	12.0	14.0
AST6-R1/4	6	R1/4	18.5	29.2	18.5	47.7	26.2	11.0	15	14.0×15.4	12.6	7.0	5.0	12.0	21.0
AST6-R3/8	6	R3/8	18.5	30.2	18.5	48.7	27.8	12.0	15	17.0×18.5	12.6	9.0	5.0	12.0	29.0
AST8-R1/8	8	R1/8	20.7	26.2	20.7	46.9	28.4	8.0	16	14.0×15.4	14.6	5.0	5.0	18.5	18.0
AST8-R1/4	8	R1/4	20.7	30.2	20.7	50.9	28.4	11.0	16	14.0×15.4	14.6	7.0	7.0	23.0	24.0
AST8-R3/8	8	R3/8	20.7	31.2	20.7	51.9	30.0	12.0	16	17.0×18.5	14.6	9.0	7.0	23.0	32.0
AST10-R1/8	10	R1/8	24.7	29.2	24.7	53.9	33.9	8.0	19	17.0×18.5	17.5	5.0	5.0	22.0	28.0
AST10-R1/4	10	R1/4	24.7	33.2	24.7	57.9	33.9	11.0	19	17.0×18.5	17.5	7.0	7.0	34.5	34.0
AST10-R3/8	10	R3/8	24.7	34.2	24.7	58.9	33.9	12.0	19	17.0×18.5	17.5	9.0	9.0	37.0	40.0
AST10-R1/2	10	R1/2	24.7	38.2	24.7	62.9	36.9	15.0	19	22.0×24.5	17.5	12.0	9.0	37.0	58.0
AST12-R1/4	12	R1/4	26.3	35.7	26.3	63.0	36.8	11.0	20	19.0×21.0	20.0	7.0	7.0	36.0	43.0
AST12-R3/8	12	R3/8	26.3	36.7	26.3	63.0	36.8	12.0	20	19.0×21.0	20.0	9.0	9.0	43.0	48.0
AST12-R1/2	12	R1/2	26.3	40.7	26.3	67.0	38.6	15.0	20	22.0×24.5	20.0	12.0	10.0	43.0	65.0
AST16-R3/8	16	R3/8	34.9	45.0	34.9	79.9	48.4	12.0	27	24.0×27.0	28.0	11.0	11.0	70.0	92.0
AST16-R1/2	16	R1/2	34.9	48.0	34.9	82.9	48.4	15.0	27	24.0×27.0	28.0	12.0	12.0	93.0	106.0

Tubing

Clean tubing

Processed tubing

PushOne fitting

QuickSeal fitting

Clean fitting/ Chemifit

Bamboo-shoot fitting

Control switch/ Detachable series

Jig/Tool/ Accessory

Technical information

Reference

Y joint

●Millimeter size type

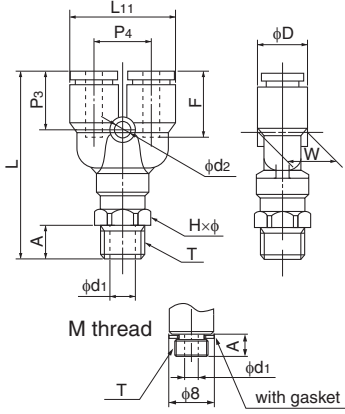

Product number	Applicable tubing outer diameter (mm)	T Thread size (M,R)	L (mm)	L ₁₁ (mm)	A (mm)	F Tubing insertion length (mm)	H×φ Width across flat (mm)	P ₃ (mm)	P ₄ (mm)	W (mm)	D (mm)	d ₁ (mm)	d ₂ (mm)	Min. inner diameter (mm)	Effective sectional area (mm ²)	Weight (g)
AY4-M5	4	M5×0.8	37.9	20.8	4.0	13	10.0×11.0	13.4	11.0	9.8	9.8	2.0	3.2	2.0	2.5	9.0
AY4-R1/8	4	R1/8	40.4	20.8	8.0	13	10.0×11.0	13.4	11.0	9.8	9.8	5.0	3.2	3.0	3.5	11.0
AY4-R1/4	4	R1/4	44.4	20.8	11.0	13	14.0×15.4	13.4	11.0	9.8	9.8	7.0	3.2	3.0	3.5	18.0
AY6-M5	6	M5×0.8	41.3	24.8	4.0	15	12.0×13.0	14.8	12.2	12.5	12.6	2.0	4.2	2.0	2.5	13.0
AY6-R1/8	6	R1/8	43.8	24.8	8.0	15	12.0×13.0	14.8	12.2	12.5	12.6	5.0	4.2	5.0	9.0	15.0
AY6-R1/4	6	R1/4	47.8	24.8	11.0	15	14.0×15.4	14.8	12.2	12.5	12.6	7.0	4.2	5.0	9.0	22.0
AY6-R3/8	6	R3/8	48.8	24.8	12.0	15	17.0×18.5	14.8	12.2	12.5	12.6	9.0	4.2	5.0	9.0	30.0
AY8-R1/8	8	R1/8	46.9	28.8	8.0	16	14.0×15.4	16.4	14.2	14.6	14.6	5.0	4.2	5.0	17.5	20.0
AY8-R1/4	8	R1/4	50.9	28.8	11.0	16	14.0×15.4	16.4	14.2	14.6	14.6	7.0	4.2	7.0	20.0	25.0
AY8-R3/8	8	R3/8	51.9	28.8	12.0	16	17.0×18.5	16.4	14.2	14.6	14.6	9.0	4.2	7.0	20.0	33.0
AY10-R1/4	10	R1/4	55.9	35.0	11.0	19	17.0×18.5	18.4	17.5	17.5	17.5	7.0	4.2	7.0	27.5	33.0
AY10-R3/8	10	R3/8	56.9	35.0	12.0	19	17.0×18.5	18.4	17.5	17.5	17.5	9.0	4.2	9.0	28.0	41.0
AY10-R1/2	10	R1/2	60.9	35.0	15.0	19	22.0×24.5	18.4	17.5	17.5	17.5	12.0	4.2	9.0	28.0	60.0
AY12-R1/4	12	R1/4	60.8	40.0	11.0	20	19.0×21.0	20.3	20.0	20.0	20.0	7.0	4.2	7.0	34.5	47.0
AY12-R3/8	12	R3/8	61.8	40.0	12.0	20	19.0×21.0	20.3	20.0	20.0	20.0	9.0	4.2	9.0	40.0	52.0
AY12-R1/2	12	R1/2	65.8	40.0	15.0	20	22.0×24.5	20.3	20.0	20.0	20.0	12.0	4.2	10.0	40.0	70.0
AY16-R3/8	16	R3/8	78.6	55.5	12.0	27	24.0×27.0	26.6	27.5	27.5	28.0	11.0	4.2	11.0	70.0	103.0
AY16-R1/2	16	R1/2	81.6	55.5	15.0	27	24.0×27.0	26.6	27.5	27.5	28.0	12.0	4.2	12.0	71.0	117.0

Union connector

●Millimeter size type

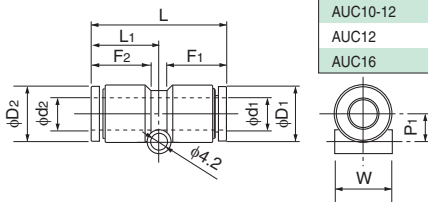

Product number	d ₁ Applicable tubing outer diameter (mm)	d ₂ Applicable tubing outer diameter (mm)	L (mm)	L ₁ (mm)	P ₁ (mm)	F ₁ Tubing insertion length (mm)	F ₂ Tubing insertion length (mm)	D ₁ (mm)	D ₂ (mm)	W (mm)	Min. inner diameter (mm)	Effective sectional area (mm ²)	Weight (g)
AUC4	4	4	31.8	15.9	5.0	13	13	9.8	9.8	9.7	3.0	3.5	4.0
AUC4-6	4	6	32.7	16.8	6.0	13	15	9.8	12.6	12.5	3.0	3.5	5.0
AUC6	6	6	33.6	16.8	6.0	15	15	12.6	12.6	12.5	5.0	12.5	6.0
AUC6-8	6	8	34.7	17.9	7.0	15	16	12.6	14.6	14.5	5.0	11.5	7.0
AUC8	8	8	35.8	17.9	7.0	16	16	14.6	14.6	14.5	7.0	28.0	8.0
AUC8-10	8	10	38.8	20.9	8.5	16	19	14.6	17.5	17.5	7.0	31.5	11.0
AUC10	10	10	41.7	20.9	8.5	19	19	17.5	17.5	17.5	9.0	45.0	14.0
AUC10-12	10	12	42.7	21.8	9.8	19	20	17.5	20.0	20.0	9.0	53.0	17.0
AUC12	12	12	43.6	21.8	9.8	20	20	20.0	20.0	20.0	11.0	67.0	19.0
AUC16	16	16	56.2	28.1	13.8	27	27	28.0	28.0	27.5	13.0	110.0	48.0

90 degree union elbow

●Millimeter size type

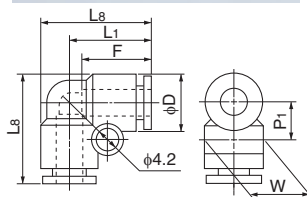

Product number	Applicable tubing outer diameter (mm)	L ₁ (mm)	L ₈ (mm)	P ₁ (mm)	F Tubing insertion length (mm)	D (mm)	W (mm)	Min. inner diameter (mm)	Effective sectional area (mm ²)	Weight (g)
AUL4	4	17.2	22.1	6.9	13	9.8	9.7	3.0	3.5	4.0
AUL6	6	18.5	24.8	8.3	15	12.6	12.5	5.0	9.5	6.0
AUL8	8	20.7	28.0	9.3	16	14.6	14.5	7.0	19.5	9.0
AUL10	10	24.7	33.4	10.8	19	17.5	17.5	9.0	32.5	15.0
AUL12	12	26.3	36.3	12.1	20	20.0	20.0	11.0	45.5	20.0

Product number	Applicable tubing outer diameter (mm)	L ₁ (mm)	L ₈ (mm)	L ₁₂ (mm)	P ₁ (mm)	F Tubing insertion length (mm)	D (mm)	W (mm)	Min. inner diameter (mm)	Effective sectional area (mm ²)	Weight (g)
* AUL16	16	34.9	48.9	50.8	12.9	27	28.0	27.5	13.0	97.5	50.0

*AUL16 has a different screw hole position.

AUL16

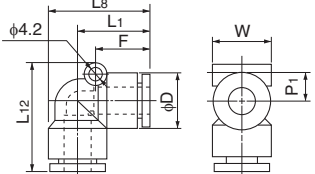

Tubing
Clean tubing
Processed tubing
PushOne fitting
QuickSeal fitting
Clean fitting/ Chemifit
Bamboo-shoot fitting
Control switch/ Detachable series
Jig/Tool/ Accessory
Technical information
Reference

90 degree branch union elbow

●Millimeter size type



Product number	Applicable tubing outer diameter (mm)	L ₁ (mm)	L ₂ (mm)	L ₃ (mm)	L ₄ (mm)	L ₁₁ (mm)	F Tubing insertion length (mm)	P ₃ (mm)	P ₄ (mm)	W (mm)	D (mm)	d ₂ (mm)	Min. inner diameter (mm)	Effective sectional area (mm ²)	Weight (g)
AULY6	6	25.6	18.0	31.9	24.3	24.8	15	14.8	12.2	12.6	12.6	4.2	5.0	—	10.0
AULY8	8	28.2	19.6	35.5	26.9	28.8	16	16.4	14.2	14.6	14.6	4.2	7.0	—	14.0
AULY10	10	31.3	22.6	40.0	31.3	35.0	19	18.4	17.5	17.5	17.5	4.2	9.0	—	23.0

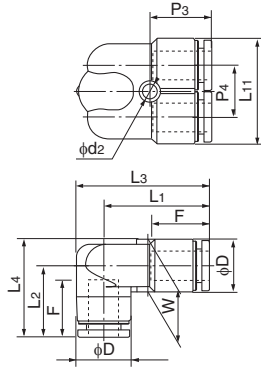

Union tee

●Millimeter size type



Product number	d ₁ Applicable tubing outer diameter (mm)	d ₂ Applicable tubing outer diameter (mm)	L ₁ (mm)	L ₅ (mm)	L ₆ (mm)	L ₈ (mm)	F ₁ Tubing insertion length (mm)	F ₂ Tubing insertion length (mm)	P ₁ (mm)	P ₂ (mm)	D ₁ (mm)	D ₂ (mm)	W (mm)	Min. inner diameter (mm)	Effective sectional area (mm ²)	Weight (g)
AUT4	4	4	17.2	34.4	17.2	22.1	13	13	6.9	14.0	9.8	9.8	9.7	3.0	3.5	6.0
AUT4-6	4	6	17.7	35.4	18.0	22.9	13	15	6.8	17.0	9.8	12.6	12.5	3.0	2.5	8.0
AUT6	6	6	18.5	37.0	18.5	24.8	15	15	8.3	17.0	12.6	12.6	12.5	5.0	4.5	9.0
AUT6-8	6	8	19.5	39.0	20.4	26.7	15	16	8.2	19.0	12.6	14.6	14.5	5.0	15.5	11.0
AUT8	8	8	20.7	41.4	20.7	28.0	16	16	9.3	19.0	14.6	14.6	14.5	7.0	19.5	13.0
AUT8-10	8	10	21.7	43.4	24.4	31.7	16	19	9.2	22.0	14.6	17.5	17.5	7.0	21.0	18.0
AUT10	10	10	24.7	49.3	24.7	33.4	19	19	10.8	22.0	17.5	17.5	17.5	9.0	32.5	22.0
AUT10-12	10	12	25.6	51.1	26.3	35.1	19	20	10.8	24.0	17.5	20.0	20.0	9.0	27.0	26.0
AUT12	12	12	26.3	52.6	26.3	36.3	20	20	12.1	24.0	20.0	20.0	20.0	11.0	45.5	29.0
AUT16	16	16	34.9	69.8	34.9	48.9	27	27	15.9	31.7	28.0	28.0	27.5	13.0	97.0	73.0

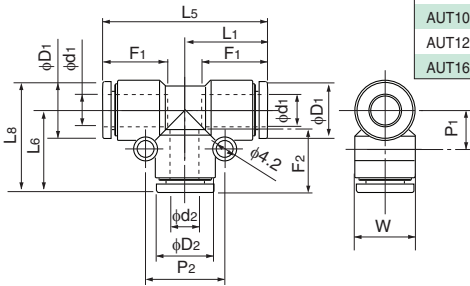

Y union

●Millimeter size type



Product number	d ₁ Applicable tubing outer diameter (mm)	d ₂ Applicable tubing outer diameter (mm)	L (mm)	L ₁₁ (mm)	F ₁ Tubing insertion length (mm)	F ₂ Tubing insertion length (mm)	P ₃ (mm)	P ₄ (mm)	W (mm)	D ₁ (mm)	D ₂ (mm)	d ₃ (mm)	Min. inner diameter (mm)	Effective sectional area (mm ²)	Weight (g)
AYB4-4	4	4	33.8	20.8	13	13	13.4	11.0	9.8	9.8	9.8	3.2	3.0	3.0	6.0
AYB4-6	4	6	34.2	20.8	13	15	13.4	11.0	12.5	9.8	12.6	3.2	3.0	2.5	8.0
AYB6-6	6	6	37.5	24.8	15	15	14.8	12.2	12.5	12.6	12.6	4.2	5.0	8.0	10.0
AYB6-8	6	8	39.2	24.8	15	16	14.8	12.2	14.5	12.6	14.6	4.2	5.0	17.0	12.0
AYB8-8	8	8	42.9	28.8	16	16	16.4	14.2	14.6	14.6	14.6	4.2	7.0	18.0	14.0
AYB8-10	8	10	44.8	28.8	16	19	16.4	14.2	17.5	14.6	17.5	4.2	7.0	22.5	19.0
AYB10-10	10	10	48.3	35.0	19	19	18.4	17.5	17.5	17.5	17.5	4.2	9.0	27.0	24.0
AYB10-12	10	12	49.4	35.0	19	20	18.4	17.5	20.0	17.5	20.0	4.2	9.0	30.0	29.0
AYB12-12	12	12	54.0	40.0	20	20	20.3	20.0	20.0	20.0	20.0	4.2	11.0	38.5	33.0

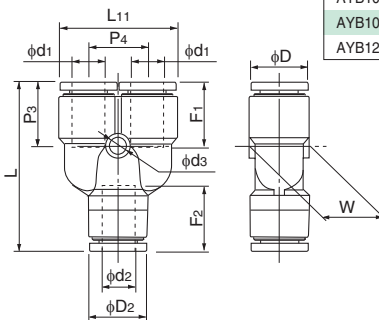

Tubing

Clean tubing

Processed tubing

PushOne fitting

QuickSeal fitting

Clean fitting/Chemfit

Bamboo-shoot fitting

Control switch/Detachable series

Jig/Tool/Accessory

Technical information

Reference

Double Y union

●Millimeter size type



Product number	d1 Applicable tubing outer diameter (mm)	d2 Applicable tubing outer diameter (mm)	L (mm)	L11 (mm)	F1 Tubing insertion length (mm)	F2 Tubing insertion length (mm)	P3 (mm)	P4 (mm)	W (mm)	D1 (mm)	D (mm)	ds (mm)	Min. inner diameter (mm)	Effective sectional area (mm ²)	Weight (g)
AUWY4-6	4	6	34.2	19.8	13	15	13.4	10.0	19.8	9.8	12.6	3.2	3.5	—	10.0
AUWY6-8	6	8	39.2	24.8	15	16	14.8	12.2	24.8	12.6	14.6	4.2	5.0	—	16.0

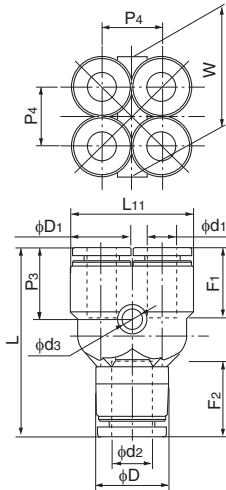

Panel touch connector

●Millimeter size type



Product number	Applicable tubing outer diameter (mm)	L (mm)	F Tubing insertion length (mm)	t Max. panel thickness (mm)	H4 (mm)	T1 Recommended panel hole diameter (mm)	Washer outer diameter (mm)	Washer thickness (mm)	Thread length (mm)	Min. inner diameter (mm)	Effective sectional area (mm ²)	Weight (g)
APC4	4	31.8	13	8.0	17.0	13	20	2.0	20	3.0	3.5	5.0
APC6	6	33.6	15	9.5	19.0	15	24	2.5	22	5.0	12.5	7.0
APC8	8	35.8	16	10.5	22.0	17	28	2.5	23	7.0	28.0	9.0
APC10	10	41.7	19	14.0	27.0	21	34	3.0	27	9.0	45.0	16.0
APC12	12	43.6	20	16.0	30.0	23	37	3.0	29	11.0	67.0	67.0

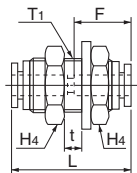

Internal panel touch connector

●Millimeter size type



Product number	Applicable tubing outer diameter (mm)	T Thread size (RC)	L (mm)	A (mm)	F Tubing insertion length (mm)	H×φ Width across flat (mm)	H4 (mm)	t Max. panel thickness (mm)	T1 Recommended panel hole diameter (mm)	d1 (mm)	Washer outer diameter (mm)	Washer thickness (mm)	Min. inner diameter (mm)	Effective sectional area (mm ²)	Weight (g)
APFC4-R1/8	4	RC1/8	27.9	8.7	13	17.0×18.5	17.0	8.0	13	3.0	20	2.0	3.0	4.0	22.0
APFC6-R1/8	6	RC1/8	29.8	8.7	15	19.0×21.0	19.0	9.0	15	5.0	24	2.5	5.0	10.5	44.0
APFC6-R1/4	6	RC1/4	35.3	13.0	15	19.0×21.0	19.0	9.0	15	5.0	24	2.5	5.0	10.5	50.0
APFC8-R1/4	8	RC1/4	34.4	13.0	16	22.0×24.5	22.0	10.5	17	7.0	28	2.5	7.0	25.0	64.0
APFC8-R3/8	8	RC3/8	38.4	13.5	16	22.0×24.5	22.0	10.5	17	7.0	28	2.5	7.0	26.0	68.0
APFC10-R1/4	10	RC1/4	40.4	13.0	19	27.0×30.0	27.0	14.0	21	9.0	34	3.0	9.0	40.0	117.0
APFC10-R3/8	10	RC3/8	40.4	13.5	19	27.0×30.0	27.0	14.0	21	9.0	34	3.0	9.0	40.0	107.0
APFC12-R1/4	12	RC1/4	42.3	13.0	20	30.0×33.5	30.0	16.0	23	10.5	37	3.0	10.5	45.0	147.0
APFC12-R3/8	12	RC3/8	42.3	13.5	20	30.0×33.5	30.0	16.0	23	11.0	37	3.0	11.0	50.0	138.0

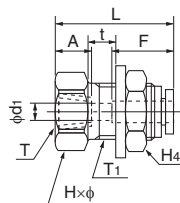

Tubing

Clean tubing

Processed tubing

PushOne fitting

QuickSeal fitting

Clean fitting/ Chemifit

Bamboo-shoot fitting

Control switch/ Detachable series

Jig/Tool/ Accessory

Technical information

Reference

90 degree panel touch elbow

●Millimeter size type



Product number	Applicable tubing outer diameter (mm)	L ₁ (mm)	L ₂ (mm)	L ₃ (mm)	L ₄ (mm)	F Tubing insertion length (mm)	H×φ Width across flat (mm)	H ₄ Width across flat (mm)	t Max. panel thickness (mm)	T ₁ Recommended panel hole diameter (mm)	D (mm)	Washer outer diameter (mm)	Washer thickness (mm)	Min. inner diameter (mm)	Effective sectional area (mm ²)	Weight (g)
APL4	4	17.2	35.6	27.7	40.5	13	17.0×18.5	17.0	7.5	13	9.8	21	2.5	3.0	—	32.0
APL6	6	18.5	40.0	30.5	46.3	15	19.0×21.0	19.0	9.0	15	12.6	24	2.5	5.0	—	43.0
APL8	8	20.7	43.6	34.7	50.9	16	22.0×24.5	22.0	10.0	17	14.6	28	3.0	7.0	—	62.0
APL10	10	24.7	51.6	41.7	60.3	19	27.0×30.0	27.0	14.0	21	17.5	34	3.0	9.0	—	101.0
APL12	12	26.3	56.0	44.8	66.0	20	30.0×33.5	30.0	16.0	23	20.0	37	3.0	10.0	—	126.0

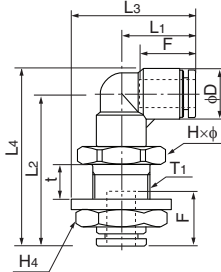

Reducer

●Millimeter size type



Product number	Applicable tubing outer diameter (mm)	D ₁ Insertion part diameter (mm)	L (mm)	L ₁₀ (mm)	F Tubing insertion length (mm)	D (mm)	Min. inner diameter (mm)	Effective sectional area (mm ²)	Weight (g)
AR4-6-Z2	4	6	34.0	17.5	13	9.8	3.0	3.5	3.0
AR4-8-Z2	4	8	31.5	18.5	13	9.8	3.0	3.5	3.0
AR6-8-Z2	6	8	34.3	17.3	15	12.6	5.0	10.5	4.0
AR6-10-Z2	6	10	35.2	20.2	15	12.6	5.0	10.5	4.0
AR6-12-Z2	6	12	36.7	20.9	15	12.6	5.0	10.5	5.0
AR8-10-Z2	8	10	39.0	18.5	16	14.6	7.0	28.0	5.0
AR8-12-Z2	8	12	37.9	15.8	16	14.6	7.0	28.0	5.0
AR10-12-Z2	10	12	42.5	20.5	19	17.5	9.0	45.0	8.0

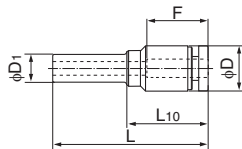

Adapter elbow

●Millimeter size type



Product number	Applicable tubing outer diameter (mm)	D ₁ Insertion part diameter (mm)	L ₁ (mm)	L ₂ (mm)	L ₃ (mm)	L ₄ (mm)	L ₁₀ (mm)	F Tubing insertion length (mm)	D (mm)	Min. inner diameter (mm)	Effective sectional area (mm ²)	Weight (g)
AAL4	4	4	17.2	30.7	22.1	35.6	14.7	13	9.8	3.0	4.0	6.0
AAL6	6	6	18.5	34.2	24.4	40.5	17.7	15	12.6	4.5	12.0	10.0
AAL8	8	8	20.7	35.7	27.6	43.0	18.7	16	14.6	6.0	20.0	14.0
AAL10	10	10	24.7	41.2	33.0	50.0	22.7	19	17.5	8.0	35.0	22.0
AAL12	12	12	26.3	45.2	35.7	55.2	25.2	20	20.0	10.0	43.0	30.0

⚠ Caution: Once an adapter elbow is inserted into a PushOne part, the part cannot be used to connect a tubing.

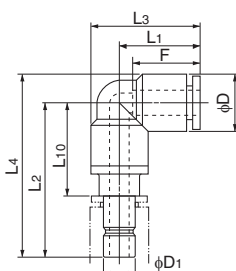

Y plug

● Millimeter size type



Product number	Applicable tubing outer diameter (mm)	D1 Insertion part diameter (mm)	L (mm)	L10 (mm)	L11 (mm)	F Tubing insertion length (mm)	P3 (mm)	P4 (mm)	W (mm)	D (mm)	d2 (mm)	Min. inner diameter (mm)	Effective sectional area (mm ²)	Weight (g)
AYA4-4	4	4	48.4	32.4	20.8	13	13.4	11.0	9.8	9.8	3.2	3.0	3.5	8.0
AYA6-6	6	6	52.8	36.3	24.8	15	14.8	12.2	12.5	12.6	4.2	4.5	9.0	14.0
AYA8-8	8	8	56.4	39.4	28.8	16	16.4	14.2	14.6	14.6	4.2	6.0	18.0	19.0
AYA10-10	10	10	63.9	45.4	35.0	19	18.4	17.5	17.5	17.5	4.2	8.0	28.0	31.0
AYA12-12	12	12	70.3	50.3	40.0	20	20.3	20.0	20.0	20.0	4.2	10.0	40.0	42.0

⚠ Caution: Once a Y plug elbow is inserted into a PushOne part, the part cannot be used to connect a tubing.

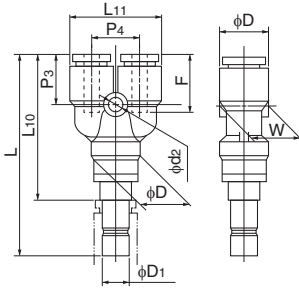

Manifold A type

● Millimeter size type



Product number	Applicable tubing outer diameter (mm)		A Number of ports	L (mm)	L1 (mm)	L2 (mm)	L3 (mm)	L4 (mm)	L5 (mm)	L6 (mm)	L7 (mm)	L8 (mm)	F1 Tubing insertion length (mm)	F2 Tubing insertion length (mm)	P1 (mm)	d1 (mm)	d2 (mm)	Effective sectional area (mm ²)	Weight (g)
	Port A	Port B																	
AMA4-8-6	4	8	6	62.8	31.4	36.0	10.0	19.5	28.8	19.5	9.3	18.5	13	16	10.6	9.8	14.6	—	20.0
AMA4-8-10	4	8	10	84.3	42.2	57.2	10.0	19.8	29.1	19.8	9.3	18.5	13	16	10.6	9.8	14.6	—	33.0
AMA6-10-6	6	10	6	74.7	37.4	44.0	11.5	20.8	30.1	20.8	9.3	18.5	15	19	13.0	12.6	17.5	—	37.0
AMA6-10-10	6	10	10	100.7	50.4	70.0	11.5	21.1	30.4	21.1	9.3	18.5	15	19	13.0	12.6	17.5	—	54.0
AMA8-12-6	8	12	6	84.2	42.1	51.0	12.5	23.0	33.5	23.0	10.5	21.0	16	20	15.5	14.6	20.0	—	50.0
AMA8-12-10	8	12	10	115.1	57.6	82.0	12.5	23.0	33.5	23.0	10.5	21.0	16	20	15.5	14.6	20.0	—	68.0

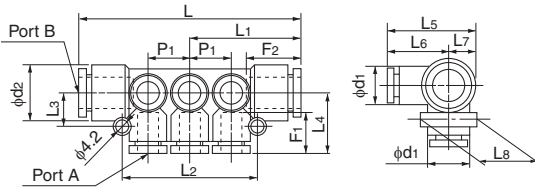

Manifold B type

● Millimeter size type



Product number	Applicable tubing outer diameter (mm)		Thread size (RC)	A Number of ports	L (mm)	L1 (mm)	L2 (mm)	L3 (mm)	L4 (mm)	L5 (mm)	L6 (mm)	L7 (mm)	L8 (mm)	F1 Tubing insertion length (mm)	P1 (mm)	d1 (mm)	H×φ Width across flat (mm)	Effective sectional area (mm ²)	Weight (g)
	Port A	Port B																	
AMB4-1/4-6	4	RC1/4	6	84.0	42.0	36.0	10.0	19.5	28.8	19.5	9.3	18.5	13	10.6	9.8	17.0x18.5	—	58.0	
AMB4-1/4-10	4	RC1/4	10	105.5	52.8	57.2	10.0	19.8	29.1	19.8	9.3	18.5	13	10.6	9.8	17.0x18.5	—	67.0	
AMB6-1/4-6	6	RC1/4	6	96.0	48.0	44.0	11.5	20.8	30.1	20.8	9.3	18.5	15	13.0	12.6	17.0x18.5	—	79.0	
AMB6-1/4-10	6	RC1/4	10	122.0	61.0	70.0	11.5	21.1	30.4	21.1	9.3	18.5	15	13.0	12.6	17.0x18.5	—	96.0	
AMB8-3/8-6	8	RC3/8	6	105.6	52.8	51.0	12.5	23.0	33.5	23.0	10.5	21.0	16	15.5	14.6	19.0x21.0	—	92.0	
AMB8-3/8-10	8	RC3/8	10	136.5	68.3	82.0	12.5	23.0	33.5	23.0	10.5	21.0	16	15.5	14.6	19.0x21.0	—	117.0	

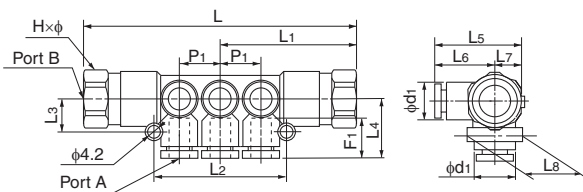

Tubing cap

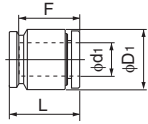

●Millimeter size type

Product number	d ₁ Applicable tubing outer diameter (mm)	D ₁ (mm)	F Tubing insertion length (mm)	L (mm)	Weight (g)
ACC4	4	9.8	13	15.0	2.0
ACC6	6	12.6	15	16.9	3.0
ACC8	8	14.6	16	17.9	4.0
ACC10	10	17.5	19	21.7	6.0
ACC12	12	20.0	20	22.6	8.0

Blank plug

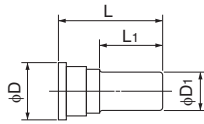

●Millimeter size type

Product number	D ₁ Insertion part diameter (mm)	L (mm)	L ₁ (mm)	D (mm)	Weight (g)
BC4	4	28.0	15.5	7.7	0.8
BC6	6	28.0	16.0	9.7	1.2
BC8	8	29.0	16.0	11.7	1.7
BC10	10	32.0	17.7	14.0	2.5
BC12	12	34.0	20.4	16.0	3.8

⚠ Caution: Material: POM (not flame-retardant resin)

Nipple

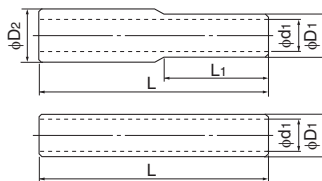

●Millimeter size type

Product number	D ₁ Insertion part diameter (mm)	D ₂ Insertion part diameter (mm)	d ₁ (mm)	L (mm)	L ₁ (mm)	Weight (g)
EN4	4	—	2.5	37.0	—	1.0
EN4-6	4	6	2.5	38.0	18.5	1.0
EN6	6	—	4.0	39.0	—	1.0
EN6-8	6	8	4.0	41.0	19.5	1.0
EN8	8	—	6.0	43.0	—	1.0
EN8-10	8	10	6.0	46.0	21.5	2.0
EN10	10	—	7.5	49.0	—	2.0
EN10-12	10	12	7.5	50.5	24.5	3.0
EN12	12	—	9.0	52.0	—	3.0

⚠ Caution: Material: POM (not flame-retardant resin)

Tubing

Clean tubing

Processed tubing

PushOne fitting

QuickSeal fitting

Clean fitting/Chemifit

Bamboo-shoot fitting

Control switch/Detachable series

Jig/Tool/Accessory

Technical information

Reference

PushOne™ Series

PushOne™ A Series Mini Type

PushOne™ fittings for general air pressure

Features

- **PushOne connection of tubing**
The tubes can be connected without using a jig or tools.
- **Electroless nickel plated**
Prevents degradation of surface and dissolution of copper ions into fluid.
- **Compact body**
Suitable for narrow piping or compact design equipment.
- **Sealing-processed R thread**
Sealing tape is not required.



Cross-sectional structure diagram

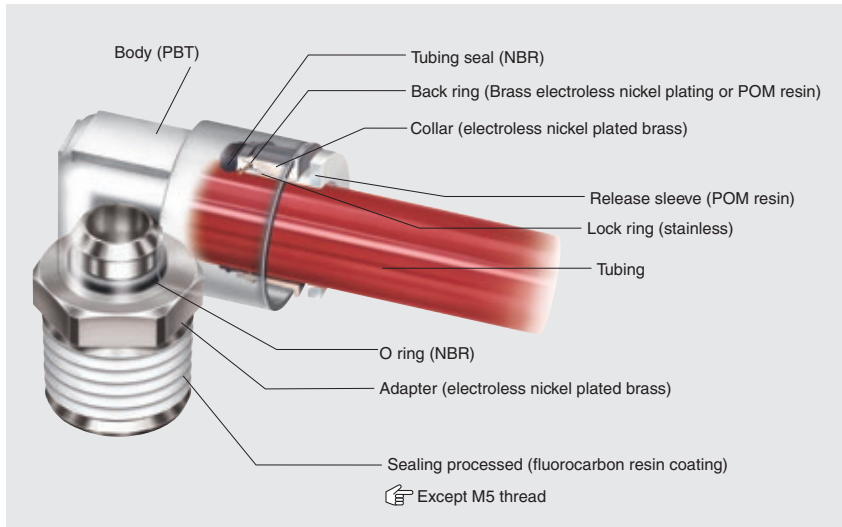

Operating fluid, working temperature range

Operating fluid	Working temperature range
Air	-20°C~+80°C

☞ See "Combination List of Tubing and Fitting" on page 8.

Pressure condition

Maximum working pressure: 1.0MPa
Negative pressure performance: -99.975kPa

Handling instructions

⚠ Caution: When the working conditions of tubes and fittings differ, use them under the lower specified conditions.

⚠ Caution: Do not bend the pipe sharply near the tubing insertion port of the fitting. Keep the tubing straight for twice as long as the tubing diameter from the insertion port.

☞ See page 34 for the common handling instructions for fittings.

Product number example

AL 6 - R1/8 - M

AL: Shape
6: Applicable tubing outer diameter
R: Thread size
M: Mini type

Size comparison of mini types



Applicable tubing

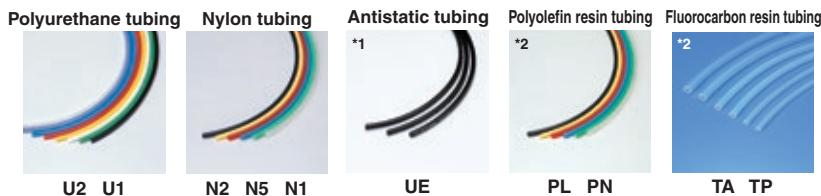

- (*1) When the PushOne E series of the Mini type is used with a UE tubing, choose a metal body type including a connector and a hexagonal socket to maintain conductivity between the tubing and the fittings.
- (*2) Combinatory use of PL, PN, TA or TP tubing and PushOne E series of the Mini type mixes general and clean type performances. When using them together in a clean environment, be aware of how this could lower the cleanliness level.

Related products and product introduction

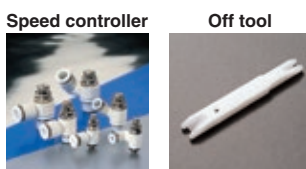

Reference

Instruction manualP.170
Effective sectional area ..P.168
Negative-pressure performance listP.169

Tubing

Clean tubing

Processed tubing

PushOne fitting

QuickSeal fitting

Clean fitting/Chemifit

Bamboo-shoot fitting

Control switch/Detachable series

Jig/Tool/Accessory

Technical information

Reference

PushOne™ A Series Mini Type

Shape list

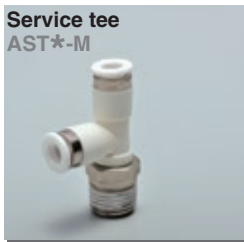

Tubing

Clean tubing

Processed tubing

PushOne fitting

QuickSeal fitting

Clean fitting/Chemifit

Bamboo-shoot fitting

Control switch/Detachable series

Jig/Tool/Accessory

Technical information

Reference

“PushOne E series mini type,” which has been favored by our customers for many years, was discontinued as of August 2014. Please ask for the white body “PushOne A Series mini type” from now on.

Connector



●Millimeter size type

Product number	Applicable tubing outer diameter (mm)	T Thread size (M,R)	L (mm)	A (mm)	F Tubing insertion length (mm)	H×φ Width across flat (mm)	d ₁ Min. inner diameter (mm)	Effective sectional area (mm ²)	Weight (g)
AC3-M3-M	3	M3×0.5	14.9	3.0	11.0	5.5×6.0	1.5	2.0	1.3
AC3-M5-M	3	M5×0.8	15.9	3.5	11.0	7.0×7.7	2.0	2.5	3.1
AC4-M3-M	4	M3×0.5	15.9	3.0	11.5	8.0×8.8	1.5	2.0	2.9
AC4-M5-M	4	M5×0.8	15.9	3.5	11.5	8.0×8.8	2.5	3.5	3.1
AC4-R1/8-M	4	R1/8	15.7	7.3	11.5	10.0×11.0	2.5	4.0	6.1
AC6-M5-M	6	M5×0.8	17.0	3.5	12.5	10.0×11.0	2.5	4.5	4.1
AC6-R1/8-M	6	R1/8	18.5	7.3	12.5	10.0×11.0	4.0	9.0	6.3

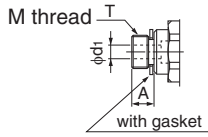
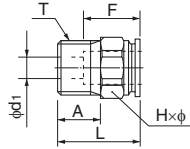

Hexagon socket connector

●Millimeter size type



Product number	Applicable tubing outer diameter (mm)	T Thread size (M,R)	L (mm)	A (mm)	F Tubing insertion length (mm)	h Width across flat (mm)	D (mm)	d ₁ Min. inner diameter (mm)	Effective sectional area (mm ²)	Weight (g)
AC3-M3A-M	3	M3×0.5	14.9	3.0	11.0	1.5	5.6	1.5	2.0	1.2
AC3-M5A-M	3	M5×0.8	15.9	3.5	11.0	2.0	6.8	2.0	2.5	2.9
AC4-M3A-M	4	M3×0.5	15.9	3.0	11.5	1.5	8.0	1.5	2.0	2.5
AC4-M5A-M	4	M5×0.8	15.9	3.5	11.5	2.5	8.0	2.5	3.5	2.8
AC4-R1/8A-M	4	R1/8	15.7	7.3	11.5	2.5	10.0	2.5	4.0	5.8
AC6-M5A-M	6	M5×0.8	17.0	3.5	12.5	2.5	9.8	2.5	4.5	3.6
AC6-R1/8A-M	6	R1/8	18.5	7.3	12.5	4.0	10.0	4.0	9.0	5.7

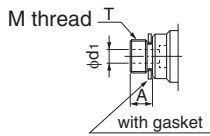
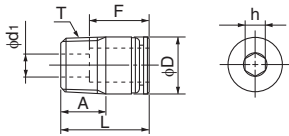

90 degree elbow

●Millimeter size type



Product number	Applicable tubing outer diameter (mm)	T Thread size (M,R)	L ₁ (mm)	L ₂ (mm)	L ₃ (mm)	L ₄ (mm)	A (mm)	F Tubing insertion length (mm)	H×φ Width across flat (mm)	D (mm)	d ₁ (mm)	Min. inner diameter (mm)	Effective sectional area (mm ²)	Weight (g)
AL3-M3-M	3	M3×0.5	12.6	12.0	15.6	15.2	3.0	11.0	5.5×6.0	6.3	1.5	1.5	1.5	1.6
AL3-M5-M	3	M5×0.8	12.6	13.0	16.4	16.2	3.5	11.0	7.0×7.7	6.3	2.5	1.5	1.5	2.2
AL4-M3-M	4	M3×0.5	14.4	12.5	18.8	16.5	3.0	11.5	8.0×8.8	8.0	1.5	1.5	2.0	2.6
AL4-M5-M	4	M5×0.8	14.4	13.0	18.8	17.0	3.5	11.5	8.0×8.8	8.0	2.5	2.5	3.5	3.2
AL4-R1/8-M	4	R1/8	14.4	16.0	19.9	20.0	8.0	11.5	10.0×11.0	8.0	5.0	3.0	4.0	6.1
AL6-M5-M	6	M5×0.8	15.6	14.0	20.0	19.0	3.5	12.5	8.0×8.8	10.0	2.5	2.5	4.5	3.6
AL6-R1/8-M	6	R1/8	15.6	17.0	21.1	22.0	8.0	12.5	10.0×11.0	10.0	5.0	4.0	8.0	6.5

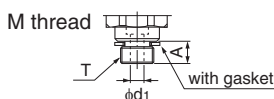
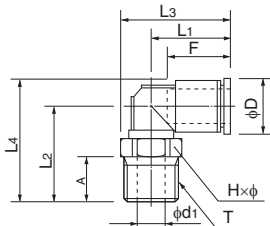

Tubing

Clean tubing

Processed tubing

PushOne fitting

QuickSeal fitting

Clean fitting/ Chemifit

Bamboo-shoot fitting

Control switch/ Detachable series

Jig/Tool/ Accessory

Technical information

Reference

90 degree long elbow

●Millimeter size type



Product number	Applicable tubing outer diameter (mm)	T Thread size (M,R)	L1 (mm)	L2 (mm)	L3 (mm)	L4 (mm)	A (mm)	F Tubing insertion length (mm)	H×φ Width across flat (mm)	D (mm)	d1 (mm)	Min. inner diameter (mm)	Effective sectional area (mm ²)	Weight (g)
ALL3-M3-M	3	M3×0.5	12.6	20.0	15.6	23.2	3.0	11.0	5.5×6.0	6.3	1.5	1.5	1.5	3.4
ALL3-M5-M	3	M5×0.8	12.6	21.0	16.4	24.2	3.5	11.0	7.0×7.7	6.3	2.5	1.5	1.5	4.5
ALL4-M3-M	4	M3×0.5	14.4	24.5	18.8	28.5	3.0	11.5	8.0×8.8	8.0	1.5	1.5	2.0	6.8
ALL4-M5-M	4	M5×0.8	14.4	25.0	18.8	29.0	3.5	11.5	8.0×8.8	8.0	2.5	2.5	3.5	7.4
ALL4-R1/8-M	4	R1/8	14.4	28.0	19.9	32.0	8.0	11.5	10.0×11.0	8.0	5.0	3.0	4.0	12.7
ALL6-M5-M	6	M5×0.8	15.6	26.0	20.0	31.0	3.5	12.5	8.0×8.8	10.0	2.5	2.5	4.5	7.8
ALL6-R1/8-M	6	R1/8	15.6	29.0	21.1	34.0	8.0	12.5	10.0×11.0	10.0	5.0	4.0	8.0	13.1

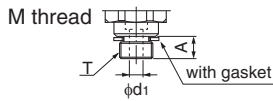
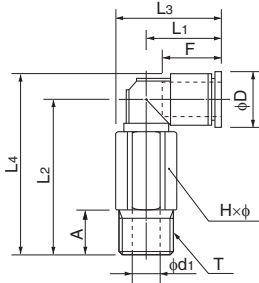

Tee

●Millimeter size type



Product number	Applicable tubing outer diameter (mm)	T Thread size (M,R)	L1 (mm)	L2 (mm)	L4 (mm)	L5 (mm)	A (mm)	F Tubing insertion length (mm)	H×φ Width across flat (mm)	D (mm)	d1 (mm)	Min. inner diameter (mm)	Effective sectional area (mm ²)	Weight (g)
AT3-M3-M	3	M3×0.5	12.6	12.0	15.2	25.1	3.0	11.0	5.5×6.0	6.3	1.5	1.5	1.5	2.1
AT3-M5-M	3	M5×0.8	12.6	13.0	16.2	25.1	3.5	11.0	7.0×7.7	6.3	2.5	1.5	1.5	2.7
AT4-M3-M	4	M3×0.5	14.9	12.5	16.5	29.8	3.0	11.5	8.0×8.8	8.0	1.5	1.5	2.0	3.5
AT4-M5-M	4	M5×0.8	14.9	13.0	17.0	29.8	3.5	11.5	8.0×8.8	8.0	2.5	2.5	3.5	4.1
AT4-R1/8-M	4	R1/8	14.9	16.0	20.0	29.8	8.0	11.5	10.0×11.0	8.0	5.0	3.0	4.0	7.0
AT6-M5-M	6	M5×0.8	16.1	14.0	19.0	32.1	3.5	12.5	8.0×8.8	10.0	2.5	2.5	4.5	4.8
AT6-R1/8-M	6	R1/8	16.1	17.0	22.0	32.1	8.0	12.5	10.0×11.0	10.0	5.0	4.0	8.0	7.7

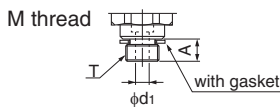
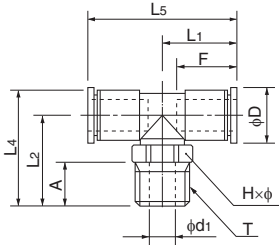

Service tee

●Millimeter size type



Product number	Applicable tubing outer diameter (mm)	T Thread size (M,R)	L1 (mm)	L2 (mm)	L6 (mm)	L7 (mm)	L8 (mm)	A (mm)	F Tubing insertion length (mm)	H×φ Width across flat (mm)	D (mm)	d1 (mm)	Min. inner diameter (mm)	Effective sectional area (mm ²)	Weight (g)
AST3-M3-M	3	M3×0.5	12.6	12.0	12.6	24.6	15.7	3.0	11.0	5.5×6.0	6.3	1.5	1.5	1.5	2.1
AST3-M5-M	3	M5×0.8	12.6	13.0	12.6	25.6	16.4	3.5	11.0	7.0×7.7	6.3	2.5	1.5	1.5	2.7
AST4-M3-M	4	M3×0.5	14.9	12.5	14.9	27.4	19.3	3.0	11.5	8.0×8.8	8.0	1.5	1.5	2.0	3.5
AST4-M5-M	4	M5×0.8	14.9	13.0	14.9	27.9	19.3	3.5	11.5	8.0×8.8	8.0	2.5	2.5	3.5	4.1
AST4-R1/8-M	4	R1/8	14.9	16.0	14.9	30.9	20.4	8.0	11.5	10.0×11.0	8.0	5.0	3.0	4.0	7.0
AST6-M5-M	6	M5×0.8	16.1	14.0	16.1	30.1	21.1	3.5	12.5	8.0×8.8	10.0	2.5	2.5	4.5	4.8
AST6-R1/8-M	6	R1/8	16.1	17.0	16.1	33.1	21.6	8.0	12.5	10.0×11.0	10.0	5.0	4.0	8.0	7.7

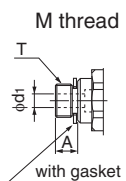
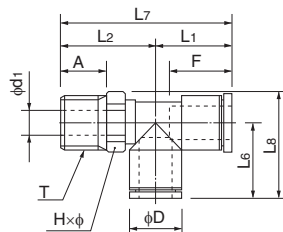

Y joint

●Millimeter size type



Product number	Applicable tubing outer diameter (mm)	T Thread size (M,R)	L (mm)	L ₁ (mm)	A (mm)	F Tubing insertion length (mm)	H×φ Width across flat (mm)	P ₃ (mm)	P ₄ (mm)	W (mm)	D (mm)	d ₁ (mm)	Min. inner diameter (mm)	Effective sectional area (mm ²)	Weight (g)
AY4-M3-M	4	M3×0.5	26.6	17.0	3.0	11.5	8.0×8.8	11.4	9.0	8.0	8.0	1.5	1.5	1.5	3.7
AY4-M5-M	4	M5×0.8	27.1	17.0	3.5	11.5	8.0×8.8	11.4	9.0	8.0	8.0	2.5	2.5	2.5	4.3
AY4-R1/8-M	4	R1/8	30.1	17.0	8.0	11.5	10.0×11.0	11.4	9.0	8.0	8.0	5.0	3.0	2.5	7.2
AY6-M5-M	6	M5×0.8	28.6	21.0	3.5	12.5	8.0×8.8	12.1	11.0	10.0	10.0	2.5	2.5	4.0	5.0
AY6-R1/8-M	6	R1/8	31.6	21.0	8.0	12.5	10.0×11.0	12.1	11.0	10.0	10.0	5.0	4.0	5.0	7.9

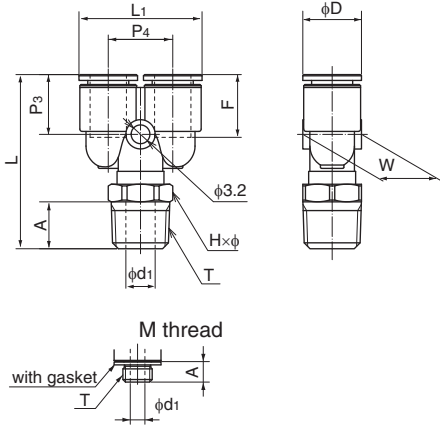

Union connector

●Millimeter size type



Product number	Applicable tubing outer diameter (mm)	L (mm)	L ₁ (mm)	P ₁ (mm)	F Tubing insertion length (mm)	D (mm)	W (mm)	Min. inner diameter (mm)	Effective sectional area (mm ²)	Weight (g)
AUC3-M	3	23.2	11.6	3.6	11.0	6.3	6.0	2.0	2.5	1.1
AUC4-M	4	25.3	12.7	4.5	11.5	8.0	8.0	3.0	4.0	1.8
AUC6-M	6	26.6	13.3	5.4	12.5	10.0	10.0	4.0	8.5	2.5

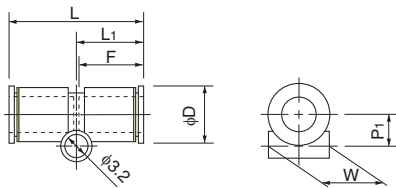

90 degree union elbow

●Millimeter size type



Product number	Applicable tubing outer diameter (mm)	L ₁ (mm)	L ₈ (mm)	P ₁ (mm)	F Tubing insertion length (mm)	D (mm)	d ₂ (mm)	W (mm)	Min. inner diameter (mm)	Effective sectional area (mm ²)	Weight (g)
AUL3-M	3	12.6	15.7	4.1	11.0	6.3	3.1	6.0	2.0	2.0	1.1
AUL4-M	4	14.9	18.9	5.0	11.5	8.0	3.2	8.0	3.0	3.5	2.0
AUL6-M	6	16.1	21.1	6.5	12.5	10.0	3.2	10.0	4.0	8.0	2.7

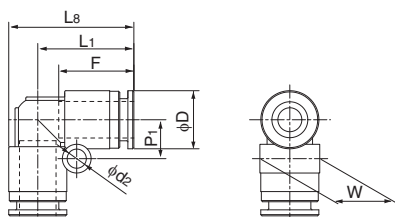

Tubing
Clean tubing
Processed tubing
PushOne fitting
QuickSeal fitting
Clean fitting/ Chemifit
Bamboo-shoot fitting
Control switch/ Detachable series
Jig/Tool/ Accessory
Technical information
Reference

Union tee

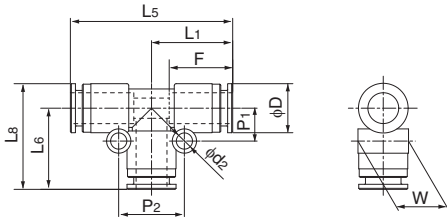

●Millimeter size type

Product number	Applicable tubing outer diameter (mm)	L1 (mm)	L5 (mm)	L6 (mm)	L8 (mm)	P1 (mm)	P2 (mm)	F Tubing insertion length (mm)	D (mm)	d2 (mm)	W (mm)	Min. inner diameter (mm)	Effective sectional area (mm ²)	Weight (g)
AUT3-M	3	12.6	25.1	12.6	15.7	4.1	8.2	11.0	6.3	3.2	6.0	2.0	2.0	1.7
AUT4-M	4	14.9	29.8	14.9	18.9	5.0	10.0	11.5	8.0	3.2	8.0	3.0	3.5	3.0
AUT6-M	6	16.1	32.1	16.1	21.1	6.5	13.0	12.5	10.0	3.2	10.0	4.0	8.0	3.9

Y union

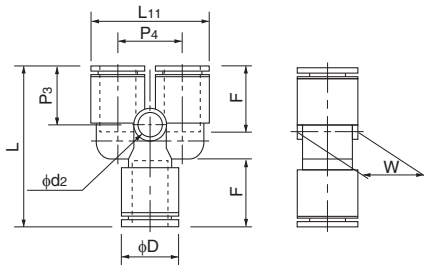

●Millimeter size type

Product number	Applicable tubing outer diameter (mm)	L (mm)	L11 (mm)	F Tubing insertion length (mm)	P3 (mm)	P4 (mm)	W (mm)	D (mm)	d2 (mm)	Min. inner diameter (mm)	Effective sectional area (mm ²)	Weight (g)
AYB3-M	3	25.7	13.3	11.0	10.9	7.0	6.0	6.3	2.0	2.0	2.0	1.8
AYB4-M	4	28.8	17.0	11.5	11.4	9.0	8.0	8.0	3.2	3.0	2.0	3.1
AYB6-M	6	31.1	21.0	12.5	12.1	11.0	10.0	10.0	3.2	4.0	8.0	4.0

Blank plug



See the PushOne E series (P.71) for the product number and part sizes.

Nipple



See the PushOne E series (P.71) for the product number and part sizes.

Tubing

Clean tubing

Processed tubing

PushOne fitting

QuickSeal fitting

Clean fitting/Chemifit

Bamboo-shoot fitting

Control switch/Detachable series

Jig/Tool/Accessory

Technical information

Reference

PushOne™ E Series

PushOne™ fittings for general air pressure (flame-resistant)

Features

- **PushOne connection of tubing**
The tubes can be connected without using a jig or tools.
- **Electroless nickel plated**
Prevents degradation of surface and dissolution of copper ions in fluid.
- **Flame-resistant resin (compliant with V-0 of UL94 standard)**
Made of flame-resistant resin PBT. High self-extinguishing performance is compliant with V-0 of UL94 standard. Usable under an environment with spatters.
- **Sealing-processed R thread**
Sealing tape is not required.



Cross-sectional structure diagram

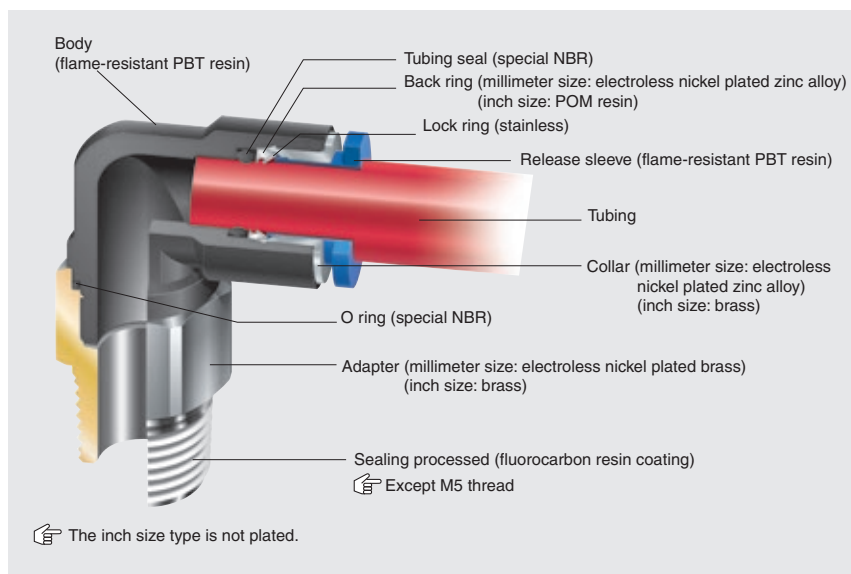

Operating fluid, working temperature range

Operating fluid	Working temperature range
Air	-20°C~+80°C
Water	0°C~+40°C

See "Combination List of Tubing and Fitting" on page 8.

Pressure condition

Maximum working pressure: 1.0MPa
Negative pressure performance: -99.975kPa

Handling instructions

- ⚠ Caution: When the working conditions of tubes and fittings differ, use them under the lower specified conditions.
- ⚠ Caution: When water is used as the operating fluid, confirm that there is no water leakage damage to equipment and instruments due to construction failure.
- ⚠ Caution: When water is used as the operating fluid, do not allow it to freeze.
- ⚠ Caution: Do not bend the pipe sharply near the tubing insertion port of the fitting. Keep the tubing straight for twice as long as the tubing diameter from the insertion port.

See page 34 for the common handling instructions for fittings.

Product number example

EL 6 - PT1/8



Distinction of millimeter/inch sizes



The inch size type has a white release sleeve.

Applicable tubing

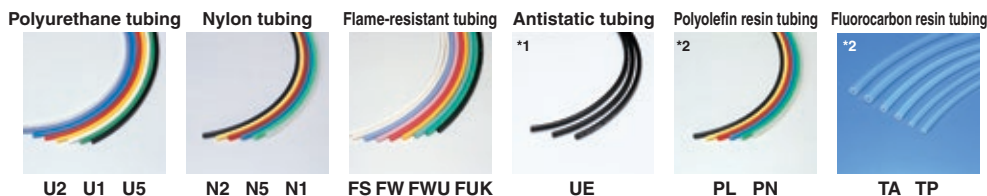

(*1) When the PushOne E series is used with a UE tubing, choose a metal body type including a connector and a hexagonal socket to maintain conductivity between the tubing and the fittings.
(*2) Combinatory use of PL, PN, TA or TP tubing and PushOne E series mixes general and clean type performances. When using them together in a clean environment, be aware of how this could lower the cleanliness level.

Related products and product introduction

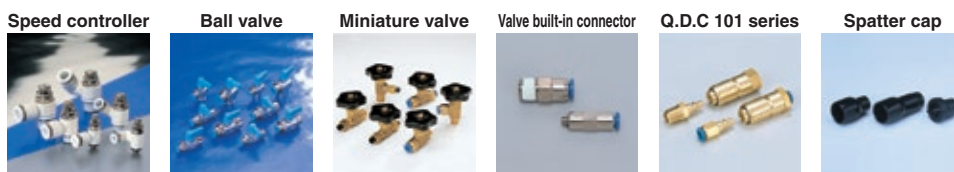

Reference

Instruction manualP.170
UL-94 standard flame testP.195
Effective sectional area ...P.168
Negative-pressure performance listP.169

PushOne™ E Series

Shape list



Tubing

Clean tubing

Processed tubing

PushOne fitting

QuickSeal fitting

Clean fitting/
Chemifit

Bamboo-shoot fitting

Control switch/
Detachable series

Jig/Tool/
Accessory

Technical information

Reference

Connector



Millimeter size type

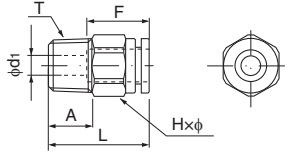

Inch size type

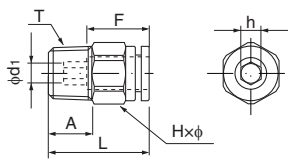

M thread

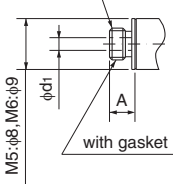

●Millimeter size type

Product number	Applicable tubing outer diameter (mm)	T Thread size (M,R)	L (mm)	A (mm)	F Tubing insertion length (mm)	H×φ Width across flat (mm)	d ₁ (mm)	Effective sectional area (mm ²)	Weight (g)
EC4-M5	4	M5×0.8	22.4	4.0	13	10.0×11.0	2.0	3.0	6.0
EC4-PT1/8	4	R1/8	19.4	8.0	13	10.0×11.0	2.5	4.0	7.0
EC4-PT1/4	4	R1/4	22.4	11.0	13	14.0×15.4	2.5	4.0	17.0
EC6-M5	6	M5×0.8	24.2	4.0	15	12.0×13.0	2.0	3.5	9.0
EC6-M6	6	M6×1.0	25.2	5.0	15	12.0×13.0	3.0	4.5	10.0
EC6-PT1/8	6	R1/8	21.2	8.0	15	12.0×13.0	4.0	10.5	9.0
EC6-PT1/4	6	R1/4	24.2	11.0	15	14.0×15.4	4.0	10.5	18.0
EC6-PT3/8	6	R3/8	25.2	12.0	15	17.0×18.5	4.0	10.5	32.0
EC8-PT1/8	8	R1/8	26.2	8.0	16	14.0×15.4	5.0	20.0	14.0
EC8-PT1/4	8	R1/4	25.2	11.0	16	14.0×15.4	6.0	25.0	16.0
EC8-PT3/8	8	R3/8	26.2	12.0	16	17.0×18.5	6.0	26.0	29.0
EC10-PT1/8	10	R1/8	30.1	8.0	19	17.0×18.5	5.0	25.0	24.0
EC10-PT1/4	10	R1/4	28.1	11.0	19	17.0×18.5	8.0	40.0	21.0
EC10-PT3/8	10	R3/8	29.1	12.0	19	17.0×18.5	8.0	40.0	29.0
EC10-PT1/2	10	R1/2	32.1	15.0	19	22.0×24.5	8.0	40.0	61.0
EC12-PT1/4	12	R1/4	34.0	11.0	20	19.0×21.0	8.0	45.0	32.0
EC12-PT3/8	12	R3/8	30.0	12.0	20	19.0×21.0	10.0	50.0	31.0
EC12-PT1/2	12	R1/2	33.0	15.0	20	22.0×24.5	10.0	50.0	58.0
EC16-PT3/8	16	R3/8	41.6	12.0	27	24.0×26.5	10.0	77.0	68.0
EC16-PT1/2	16	R1/2	43.6	15.0	27	24.0×26.5	12.0	110.5	83.0

*Made to order

●Inch size type

Product number	Applicable tubing outer diameter (inch)	T Thread size (M,R)	L (mm)	A (mm)	F Tubing insertion length (mm)	H×φ Width across flat (mm)	h Width across flat (mm)	d ₁ (mm)	Effective sectional area (mm ²)	Weight (g)
EC1/4-M5	1/4	M5×0.8	24.4	4.0	15	12.0×13.0	4.0	2.0	3.5	9.0
EC1/4-PT1/8	1/4	R1/8	21.4	8.0	15	12.0×13.0	4.0	4.0	12.0	9.0
EC1/4-PT1/4	1/4	R1/4	24.4	11.0	15	14.0×15.4	4.0	4.0	12.0	18.0
EC1/4-PT3/8	1/4	R3/8	25.4	12.0	15	17.0×18.5	4.0	4.0	12.0	32.0
EC5/16-PT1/8	5/16	R1/8	25.9	8.0	16	14.0×15.4	5.0	5.0	20.0	14.0
EC5/16-PT1/4	5/16	R1/4	24.9	11.0	16	14.0×15.4	6.0	6.0	25.0	16.0
EC5/16-PT3/8	5/16	R3/8	25.9	12.0	16	17.0×18.5	6.0	6.0	26.0	29.0
EC3/8-PT1/8	3/8	R1/8	29.7	8.0	19	17.0×18.5	—	5.0	20.0	24.0
EC3/8-PT1/4	3/8	R1/4	27.7	11.0	19	17.0×18.5	—	8.0	35.0	21.0
EC3/8-PT3/8	3/8	R3/8	28.7	12.0	19	17.0×18.5	—	8.0	35.0	29.0
EC3/8-PT1/2	3/8	R1/2	31.7	15.0	19	22.0×24.5	—	8.0	35.0	61.0
EC1/2-PT1/4	1/2	R1/4	34.0	11.0	21	19.0×21.0	—	8.0	48.0	32.0
EC1/2-PT3/8	1/2	R3/8	30.0	12.0	21	19.0×21.0	—	10.0	66.5	31.0
EC1/2-PT1/2	1/2	R1/2	33.0	15.0	21	22.0×24.5	—	10.0	66.5	58.0

☞ The inch size type is not plated.

Hexagon socket connector

●Millimeter size type

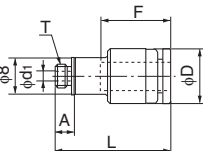
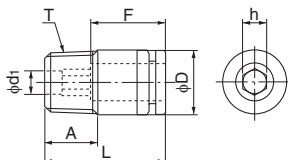

Product number	Applicable tubing outer diameter (mm)	T Thread size (M,R)	L (mm)	A (mm)	F Tubing insertion length (mm)	h Width across flat (mm)	D (mm)	d ₁ (mm)	Effective sectional area (mm ²)	Weight (g)
EC4-M5A	4	M5×0.8	19.4	4.0	13	2.0	9.8	2.0	—	5.0
EC4-PT1/8A	4	R1/8	19.4	8.0	13	2.5	9.8	2.5	—	7.0
EC6-M5A	6	M5×0.8	24.2	4.0	15	4.0	11.8	2.0	—	18.0
EC6-PT1/8A	6	R1/8	21.2	8.0	15	4.0	11.8	4.0	—	8.0
EC6-PT1/4A	6	R1/4	24.2	11.0	15	4.0	13.8	4.0	—	17.0
EC8-PT1/8A	8	R1/8	26.2	8.0	16	5.0	13.8	5.0	—	12.0
EC8-PT1/4A	8	R1/4	25.2	11.0	16	5.0	13.8	5.0	—	15.0
EC10-PT1/4A	10	R1/4	28.1	11.0	19	6.0	16.8	6.0	—	19.0
EC10-PT3/8A	10	R3/8	29.1	12.0	19	6.0	16.8	6.0	—	28.0

Tubing
Clean tubing
Processed tubing
PushOne fitting
QuickSeal fitting
Clean fitting/Chemifit
Bamboo-shoot fitting
Control switch/Detachable series
Jig/Tool/Accessory
Technical information
Reference

Internal connector

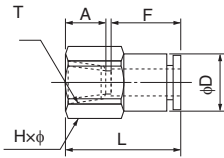

●Millimeter size type

Product number	Applicable tubing outer diameter (mm)	T Thread size (RC)	L (mm)	A (mm)	F Tubing insertion length (mm)	H×φ Width across flat (mm)	D (mm)	Min. inner diameter (mm)	Effective sectional area (mm ²)	Weight (g)
EFC4-PT1/8	4	RC1/8	23.9	8.7	13	14.0×15.4	10.0	3.0	4.0	16.0
EFC6-PT1/8	6	RC1/8	24.8	8.7	15	14.0×15.4	12.0	5.0	10.5	17.0
EFC6-PT1/4	6	RC1/4	29.3	13.0	15	17.0×18.5	12.0	5.0	10.5	26.0
EFC8-PT1/4	8	RC1/4	30.9	13.0	16	17.0×18.5	13.9	7.0	25.0	28.0
EFC8-PT3/8	8	RC3/8	31.4	13.5	16	22.0×24.5	13.9	7.0	26.0	45.0
EFC10-PT1/4	10	RC1/4	33.9	13.0	19	17.0×18.5	16.9	9.0	40.0	34.0
EFC10-PT3/8	10	RC3/8	34.4	13.5	19	22.0×24.5	16.9	9.0	40.0	50.0
EFC10-PT1/2	10	RC1/2	38.4	17.5	19	24.0×26.5	16.9	9.0	40.0	56.0
EFC12-PT1/4	12	RC1/4	34.8	13.0	20	19.0×21.0	19.0	10.0	45.0	43.0
EFC12-PT3/8	12	RC3/8	35.3	13.5	20	22.0×24.5	19.0	11.0	50.0	50.0
EFC12-PT1/2	12	RC1/2	39.3	17.5	20	24.0×26.5	19.0	11.0	50.0	58.0

●Inch size type

Product number	Applicable tubing outer diameter (inch)	T Thread size (RC)	L (mm)	A (mm)	F Tubing insertion length (mm)	H×φ Width across flat (mm)	D (mm)	Min. inner diameter (mm)	Effective sectional area (mm ²)	Weight (g)
EFC1/4-PT1/8	1/4	RC1/8	25.0	8.7	15	14.0×15.4	12.0	5.0	12.0	17.0
EFC1/4-PT1/4	1/4	RC1/4	29.5	13.0	15	17.0×18.5	12.0	5.0	12.0	26.0
EFC5/16-PT1/4	5/16	RC1/4	30.6	13.0	16	17.0×18.5	13.9	7.0	25.0	28.0
EFC5/16-PT3/8	5/16	RC3/8	31.1	13.5	16	22.0×24.5	13.9	7.0	26.0	45.0
EFC3/8-PT1/4	3/8	RC1/4	33.5	13.0	19	17.0×18.5	16.9	9.0	35.0	34.0
EFC3/8-PT3/8	3/8	RC3/8	34.0	13.5	19	22.0×24.5	16.9	9.0	35.0	50.0
EFC3/8-PT1/2	3/8	RC1/2	38.0	17.5	19	24.0×26.5	16.9	9.0	35.0	56.0
EFC1/2-PT1/4	1/2	RC1/4	35.3	13.0	21	22.0×24.5	20.0	10.0	48.0	43.0
EFC1/2-PT3/8	1/2	RC3/8	35.3	13.5	21	22.0×24.5	20.0	11.0	66.5	50.0
EFC1/2-PT1/2	1/2	RC1/2	39.3	17.5	21	24.0×26.5	20.0	11.0	66.5	58.0

☞ The inch size type is not plated.

90 degree elbow

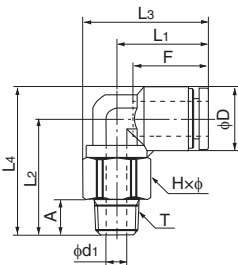

●Millimeter size type

Product number	Applicable tubing outer diameter (mm)	T Thread size (M,R)	L ₁ (mm)	L ₂ (mm)	L ₃ (mm)	L ₄ (mm)	A (mm)	F Tubing insertion length (mm)	H×φ Width across flat (mm)	D (mm)	d ₁ (mm)	Min. inner diameter (mm)	Effective sectional area (mm ²)	Weight (g)
EL4-M5-Z2	4	M5×0.8	17.2	18.3	22.7	23.2	4.0	13	10.0×11.0	9.8	2.0	2.0	3.0	6.0
EL4-PT1/8-Z2	4	R1/8	17.2	22.7	22.7	27.6	8.0	13	10.0×11.0	9.8	5.0	3.0	4.0	10.0
EL4-PT1/4-Z2	4	R1/4	17.2	24.4	24.9	29.3	12.0	13	14.0×15.4	9.8	5.0	3.0	4.0	19.0
EL6-M5-Z2	6	M5×0.8	18.5	22.2	25.0	28.5	4.0	15	12.0×13.0	12.6	2.0	2.0	3.5	10.0
EL6-M6	6	M6×1.0	18.5	22.7	25.0	29.0	5.0	15	12.0×13.0	12.6	3.0	3.0	4.5	11.0
EL6-PT1/8-Z2	6	R1/8	18.5	25.2	25.0	31.5	8.0	15	12.0×13.0	12.6	5.0	5.0	12.0	12.0
EL6-PT1/4-Z2	6	R1/4	18.5	25.8	26.2	32.1	12.0	15	14.0×15.4	12.6	7.0	5.0	12.0	17.0
EL6-PT3/8-Z2	6	R3/8	18.5	26.8	27.8	33.1	12.0	15	17.0×18.5	12.6	11.0	5.0	12.0	27.0
EL8-PT1/8-Z2	8	R1/8	20.7	26.2	28.4	33.5	8.0	16	14.0×15.4	14.6	5.0	5.0	18.5	16.0
EL8-PT1/4-Z2	8	R1/4	20.7	30.2	28.4	37.5	12.0	16	14.0×15.4	14.6	8.0	7.0	23.0	19.0
EL8-PT3/8-Z2	8	R3/8	20.7	27.8	30.0	35.1	12.0	16	17.0×18.5	14.6	9.0	7.0	23.0	28.0
EL10-PT1/8-Z2	10	R1/8	24.7	29.2	33.9	38.0	8.0	19	17.0×18.5	17.5	5.0	5.0	22.0	23.0
EL10-PT1/4-Z2	10	R1/4	24.7	32.4	33.9	41.1	12.0	19	17.0×18.5	17.5	8.0	8.0	38.0	25.0
EL10-PT3/8-Z2	10	R3/8	24.7	34.2	33.9	43.0	12.0	19	17.0×18.5	17.5	11.0	9.0	37.0	30.0
EL10-PT1/2-Z2	10	R1/2	24.7	34.3	36.9	43.0	16.0	19	22.0×24.5	17.5	12.0	9.0	37.0	53.0
EL12-PT1/4-Z2	12	R1/4	26.3	35.0	36.8	45.0	12.0	20	19.0×21.0	20.0	8.0	8.0	42.0	31.0
EL12-PT3/8-Z2	12	R3/8	26.3	33.5	36.8	43.5	12.0	20	19.0×21.0	20.0	11.0	11.0	46.0	32.0
EL12-PT1/2-Z2	12	R1/2	26.3	36.5	38.6	46.5	16.0	20	22.0×24.5	20.0	12.0	11.0	46.0	53.0
EL16-PT3/8	16	R3/8	34.9	45.0	48.4	59.0	12.0	27	24.0×27.0	28.0	11.0	11.0	70.0	70.0
EL16-PT1/2	16	R1/2	34.9	48.0	48.4	62.0	15.0	27	24.0×27.0	28.0	12.0	12.0	93.0	84.0

*Made to order

●Inch size type

Product number	Applicable tubing outer diameter (inch)	T Thread size (M,R)	L ₁ (mm)	L ₂ (mm)	L ₃ (mm)	L ₄ (mm)	A (mm)	F Tubing insertion length (mm)	H×φ Width across flat (mm)	D (mm)	d ₁ (mm)	Min. inner diameter (mm)	Effective sectional area (mm ²)	Weight (g)
EL1/4-M5	1/4	M5×0.8	18.1	22.7	24.6	29.2	4.0	15	12.0×13.0	13.0	2.0	2.0	3.0	10.0
EL1/4-PT1/8	1/4	R1/8	18.1	25.2	24.6	31.7	8.0	15	12.0×13.0	13.0	5.0	5.0	13.0	18.0
EL1/4-PT1/4	1/4	R1/4	18.1	29.2	25.8	35.7	11.0	15	14.0×15.4	13.0	7.0	5.0	13.0	18.0
EL1/4-PT3/8	1/4	R3/8	18.1	30.2	27.4	36.7	12.0	15	17.0×18.5	13.0	9.0	5.0	13.0	26.0
EL5/16-PT1/8	5/16	R1/8	20.6	26.2	28.3	33.7	8.0	16	14.0×15.4	15.0	5.0	5.0	18.5	15.0
EL5/16-PT1/4	5/16	R1/4	20.6	30.2	28.3	37.7	11.0	16	14.0×15.4	15.0	7.0	7.0	23.0	20.0
EL5/16-PT3/8	5/16	R3/8	20.6	31.2	29.9	38.7	12.0	16	17.0×18.5	15.0	9.0	7.0	23.0	28.0
EL3/8-PT1/8	3/8	R1/8	24.4	29.2	33.7	38.2	8.0	19	17.0×18.5	18.0	5.0	5.0	19.0	22.0
EL3/8-PT1/4	3/8	R1/4	24.4	33.2	33.7	42.2	11.0	19	17.0×18.5	18.0	7.0	7.0	30.0	27.0
EL3/8-PT3/8	3/8	R3/8	24.4	34.2	33.7	43.2	12.0	19	17.0×18.5	18.0	9.0	9.0	32.0	33.0
EL3/8-PT1/2	3/8	R1/2	24.4	38.2	36.7	47.2	15.0	19	22.0×24.5	18.0	12.0	9.0	32.0	52.0
EL1/2-PT1/4	1/2	R1/4	26.5	35.7	37.0	46.5	11.0	21	19.0×21.0	21.5	7.0	7.0	37.0	34.0
EL1/2-PT3/8	1/2	R3/8	26.5	36.7	37.0	47.5	12.0	21	19.0×21.0	21.5	9.0	9.0	53.0	39.0
EL1/2-PT1/2	1/2	R1/2	26.5	40.7	38.7	51.5	15.0	21	22.0×24.5	21.5	12.0	10.0	55.5	56.0

☞ The inch size type is not plated.

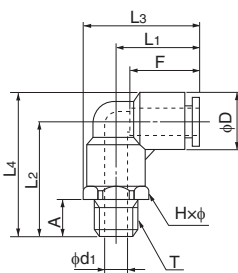

M thread

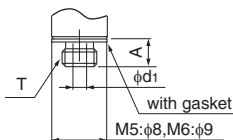

Tubing

Clean tubing

Processed tubing

PushOne fitting

QuickSeal fitting

Clean fitting/Chemifit

Bamboo-shoot fitting

Control switch/Detachable series

Jig/Tool/Accessory

Technical information

Reference

90 degree internal elbow

●Millimeter size type

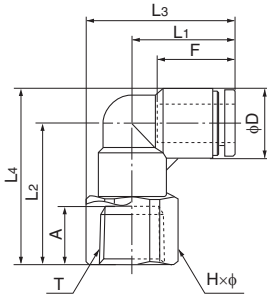

Product number	Applicable tubing outer diameter (mm)	T Thread size (RC)	L1 (mm)	L2 (mm)	L3 (mm)	L4 (mm)	A (mm)	F Tubing insertion length (mm)	H×φ Width across flat (mm)	D (mm)	Min. inner diameter (mm)	Effective sectional area (mm ²)	Weight (g)
EFL4-PT1/8	4	RC1/8	17.2	21.7	24.9	26.6	8.0	13	14.0×15.4	9.8	3.0	—	13.0
EFL6-PT1/8	6	RC1/8	18.5	24.2	26.2	30.5	8.0	15	14.0×15.4	12.6	5.0	—	15.0
EFL6-PT1/4	6	RC1/4	18.5	28.2	27.8	34.5	12.0	15	17.0×18.5	12.6	5.0	—	23.0
EFL8-PT3/8	6	RC3/8	18.5	28.7	30.8	35.0	12.5	15	22.0×24.5	12.6	5.0	—	37.0
EFL8-PT1/8	8	RC1/8	20.7	25.2	28.4	32.5	8.0	16	14.0×15.4	14.6	7.0	—	17.0
EFL8-PT1/4	8	RC1/4	20.7	29.2	30.0	36.5	12.0	16	17.0×18.5	14.6	7.0	—	25.0
EFL8-PT3/8	8	RC3/8	20.7	29.7	33.0	37.0	12.5	16	22.0×24.5	14.6	7.0	—	38.0
EFL10-PT1/4	10	RC1/4	24.7	32.2	33.9	41.0	12.0	19	17.0×18.5	17.5	9.0	—	29.0
EFL10-PT3/8	10	RC3/8	24.7	33.7	36.9	42.5	12.5	19	22.0×24.5	17.5	9.0	—	45.0
EFL12-PT3/8	12	RC3/8	26.3	36.2	38.6	46.2	12.5	20	22.0×24.5	20.0	10.0	—	49.0
EFL12-PT1/2	12	RC1/2	26.3	39.2	39.6	49.2	15.5	20	24.0×26.5	20.0	10.0	—	54.0

90 degree long elbow

●Millimeter size type

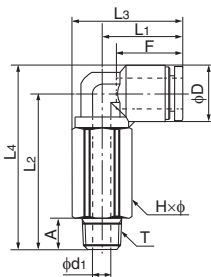

Product number	Applicable tubing outer diameter (mm)	T Thread size (M,R)	L1 (mm)	L2 (mm)	L3 (mm)	L4 (mm)	A (mm)	F Tubing insertion length (mm)	H×φ Width across flat (mm)	D (mm)	d1 (mm)	Min. inner diameter (mm)	Effective sectional area (mm ²)	Weight (g)
ELL4-M5-Z2	4	M5×0.8	17.2	29.9	22.7	34.8	4.0	13	10.0×11.0	9.8	2.0	2.0	3.0	14.0
ELL4-PT1/8-Z2	4	R1/8	17.2	32.4	22.7	37.3	8.0	13	10.0×11.0	9.8	5.0	3.0	4.0	15.0
ELL4-PT1/4-Z2	4	R1/4	17.2	36.4	24.9	41.3	12.0	13	14.0×15.4	9.8	5.0	3.0	4.0	34.0
ELL6-M5-Z2	6	M5×0.8	18.5	34.7	25.0	41.0	4.0	15	12.0×13.0	12.6	2.0	2.0	3.5	23.0
ELL6-PT1/8-Z2	6	R1/8	18.5	37.2	25.0	43.5	8.0	15	12.0×13.0	12.6	5.0	5.0	12.0	23.0
ELL6-PT1/4-Z2	6	R1/4	18.5	41.2	26.2	47.5	12.0	15	14.0×15.4	12.6	7.0	5.0	12.0	34.0
ELL6-PT3/8-Z2	6	R3/8	18.5	42.2	27.8	48.5	12.0	15	17.0×18.5	12.6	11.0	5.0	12.0	54.0
ELL8-PT1/8-Z2	8	R1/8	20.7	40.2	28.4	47.5	8.0	16	14.0×15.4	14.6	5.0	5.0	18.5	33.0
ELL8-PT1/4-Z2	8	R1/4	20.7	44.2	28.4	51.5	12.0	16	14.0×15.4	14.6	8.0	7.0	23.0	33.0
ELL8-PT3/8-Z2	8	R3/8	20.7	45.2	30.0	52.5	12.0	16	17.0×18.5	14.6	9.0	7.0	23.0	55.0
ELL10-PT1/8-Z2	10	R1/8	24.7	46.2	33.9	55.0	8.0	19	17.0×18.5	17.5	5.0	5.0	22.0	55.0
ELL10-PT1/4-Z2	10	R1/4	24.7	50.2	33.9	59.0	12.0	19	17.0×18.5	17.5	8.0	8.0	38.0	55.0
ELL10-PT3/8-Z2	10	R3/8	24.7	51.2	33.9	60.0	12.0	19	17.0×18.5	17.5	11.0	9.0	37.0	52.0
ELL10-PT1/2-Z2	10	R1/2	24.7	55.2	36.9	64.0	16.0	19	22.0×24.5	17.5	12.0	9.0	37.0	106.0
ELL12-PT1/4-Z2	12	R1/4	26.3	55.2	36.8	65.2	12.0	20	19.0×21.0	20.0	8.0	8.0	42.0	75.0
ELL12-PT3/8-Z2	12	R3/8	26.3	56.2	36.8	66.2	12.0	20	19.0×21.0	20.0	11.0	11.0	46.0	73.0
ELL12-PT1/2-Z2	12	R1/2	26.3	60.2	38.6	70.2	16.0	20	22.0×24.5	20.0	12.0	11.0	46.0	114.0

●Inch size type

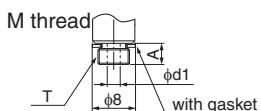
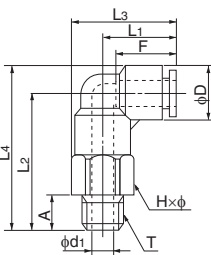

Product number	Applicable tubing outer diameter (inch)	T Thread size (M,R)	L1 (mm)	L2 (mm)	L3 (mm)	L4 (mm)	A (mm)	F Tubing insertion length (mm)	H×φ Width across flat (mm)	D (mm)	d1 (mm)	Min. inner diameter (mm)	Effective sectional area (mm ²)	Weight (g)
ELL1/4-M5	1/4	M5×0.8	18.1	34.7	24.6	41.2	4.0	15	12.0×13.0	13.0	2.0	2.0	3.0	20.0
ELL1/4-PT1/8	1/4	R1/8	18.1	37.2	24.6	43.7	8.0	15	12.0×13.0	13.0	5.0	5.0	13.0	22.0
ELL1/4-PT1/4	1/4	R1/4	18.1	41.2	25.8	47.7	11.0	15	14.0×15.4	13.0	7.0	5.0	13.0	31.0
ELL5/16-PT1/8	5/16	R1/8	20.6	40.2	28.3	47.7	8.0	16	14.0×15.4	15.0	5.0	5.0	18.5	30.0
ELL5/16-PT1/4	5/16	R1/4	20.6	44.2	28.3	51.7	11.0	16	14.0×15.4	15.0	7.0	7.0	23.0	35.0
ELL5/16-PT3/8	5/16	R3/8	20.6	45.2	29.9	52.7	12.0	16	17.0×18.5	15.0	9.0	7.0	—	—
ELL3/8-PT1/4	3/8	R1/4	24.4	50.2	33.7	59.2	11.0	19	17.0×18.5	18.0	7.0	7.0	30.0	53.0
ELL3/8-PT3/8	3/8	R3/8	24.4	51.2	33.7	60.2	12.0	19	17.0×18.5	18.0	9.0	9.0	32.0	59.0
ELL1/2-PT1/4	1/2	R1/4	26.5	55.2	37.0	66.0	11.0	21	19.0×21.0	21.5	7.0	7.0	37.0	72.0
ELL1/2-PT3/8	1/2	R3/8	26.5	56.2	37.0	67.0	12.0	21	19.0×21.0	21.5	9.0	9.0	53.0	78.0
ELL1/2-PT1/2	1/2	R1/2	26.5	60.2	38.7	71.0	15.0	21	22.0×24.5	21.5	12.0	10.0	55.5	105.0

The inch size type is not plated.

45 degree elbow

●Millimeter size type

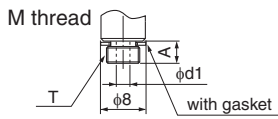
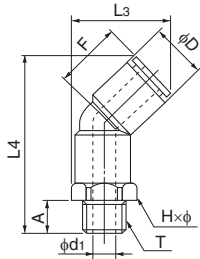

Product number	Applicable tubing outer diameter (mm)	T Thread size (M,R)	L ₃ (mm)	L ₄ (mm)	A (mm)	F Tubing insertion length (mm)	H×φ Width across flat (mm)	D (mm)	d ₁ (mm)	Min. inner diameter (mm)	Effective sectional area (mm ²)	Weight (g)
E45L4-M5	4	M5×0.8	19.7	34.4	4.0	13	10.0×11.0	9.8	2.0	2.0	3.0	7.0
E45L4-PT1/8	4	R1/8	19.7	36.9	8.0	13	10.0×11.0	9.8	5.0	3.0	4.0	9.0
E45L4-PT1/4	4	R1/4	21.9	40.9	11.0	13	14.0×15.4	9.8	7.0	3.0	4.0	16.0
E45L6-M5	6	M5×0.8	22.4	38.6	4.0	15	12.0×13.0	12.6	2.0	2.0	3.5	10.0
E45L6-PT1/8	6	R1/8	22.4	41.1	8.0	15	12.0×13.0	12.6	5.0	5.0	12.0	12.0
E45L6-PT1/4	6	R1/4	23.6	45.1	11.0	15	14.0×15.4	12.6	7.0	5.0	12.0	18.0
E45L6-PT3/8	6	R3/8	25.2	46.1	12.0	15	17.0×18.5	12.6	9.0	5.0	12.0	26.0
E45L8-PT1/8	8	R1/8	25.5	44.0	8.0	16	14.0×15.4	14.6	5.0	5.0	18.5	15.0
E45L8-PT1/4	8	R1/4	25.5	48.0	11.0	16	14.0×15.4	14.6	7.0	7.0	23.0	20.0
E45L8-PT3/8	8	R3/8	27.0	49.0	12.0	16	17.0×18.5	14.6	9.0	7.0	23.0	28.0
E45L10-PT1/8	10	R1/8	30.0	50.0	8.0	19	17.0×18.5	17.5	5.0	5.0	22.0	22.0
E45L10-PT1/4	10	R1/4	30.0	54.0	11.0	19	17.0×18.5	17.5	7.0	7.0	34.5	27.0
E45L10-PT3/8	10	R3/8	30.0	55.0	12.0	19	17.0×18.5	17.5	9.0	9.0	37.0	33.0
E45L10-PT1/2	10	R1/2	33.0	59.0	15.0	19	22.0×24.5	17.5	12.0	9.0	38.5	52.0
E45L12-PT1/4	12	R1/4	33.5	58.7	11.0	20	19.0×21.0	20.0	7.0	7.0	43.0	34.0
E45L12-PT3/8	12	R3/8	33.5	59.7	12.0	20	19.0×21.0	20.0	9.0	9.0	47.0	40.0
E45L12-PT1/2	12	R1/2	35.3	63.7	15.0	20	22.0×24.5	20.0	12.0	10.0	47.0	57.0

Universal elbow

●Millimeter size type

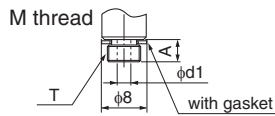
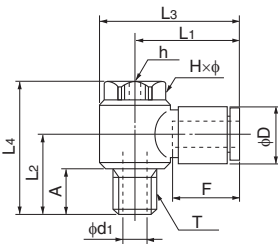

Product number	Applicable tubing outer diameter (mm)	T Thread size (M,R)	L ₁ (mm)	L ₂ (mm)	L ₃ (mm)	L ₄ (mm)	A (mm)	F Tubing insertion length (mm)	H×φ Width across flat (mm)	h (mm)	D (mm)	d ₁ (mm)	Min. inner diameter (mm)	Effective sectional area (mm ²)	Weight (g)
ELB4-M5	4	M5×0.8	20.4	11.5	25.3	21.0	4.0	13	8.0×9.0	3.0	9.8	2.0	2.0	3.0	10.0
ELB4-PT1/8	4	R1/8	23.4	17.5	30.4	30.0	9.5	13	13.0×14.0	5.0	9.8	5.0	3.0	4.0	20.0
ELB6-M5	6	M5×0.8	20.8	11.5	25.6	21.0	4.0	15	8.0×9.0	3.0	12.6	2.0	2.0	3.5	10.0
ELB6-PT1/8	6	R1/8	22.8	17.5	29.8	30.0	9.5	15	13.0×14.0	5.0	12.6	5.0	3.2	8.0	21.0
ELB6-PT1/4	6	R1/4	24.8	22.9	34.5	37.5	13.4	15	17.0×18.3	6.0	12.6	7.0	4.2	9.0	43.0
ELB8-PT1/8	8	R1/8	24.4	17.5	31.4	30.0	9.5	16	13.0×14.0	5.0	14.6	5.0	3.2	9.0	41.0
ELB8-PT1/4	8	R1/4	26.4	22.9	36.1	37.5	13.4	16	17.0×18.3	6.0	14.6	7.0	4.2	14.5	44.0
ELB8-PT3/8	8	R3/8	28.4	24.4	40.4	40.5	13.9	16	21.0×22.6	8.0	14.6	9.0	6.0	19.0	69.0
ELB10-PT1/4	10	R1/4	29.4	22.9	39.1	37.5	13.4	19	17.0×18.3	6.0	17.5	7.0	4.2	15.5	74.0
ELB10-PT3/8	10	R3/8	31.4	24.4	43.4	40.5	13.9	19	21.0×22.6	8.0	17.5	9.0	6.0	23.0	74.0
ELB12-PT3/8	12	R3/8	34.3	24.3	48.3	40.5	13.8	20	24.0×26.0	8.0	20.0	10.0	8.0	25.5	92.0
ELB12-PT1/2	12	R1/2	34.3	27.3	48.3	43.5	16.8	20	24.0×26.0	8.0	20.0	12.0	8.0	25.5	100.0

Tubing

Clean tubing

Processed tubing

PushOne fitting

QuickSeal fitting

Clean fitting/ Chemifit

Bamboo-shoot fitting

Control switch/ Detachable series

Jig/Tool/ Accessory

Technical information

Reference

90 degree branch elbow

●Millimeter size type

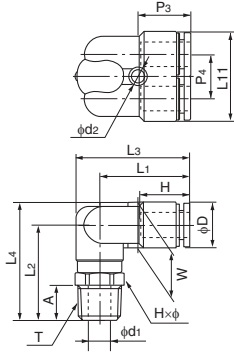

Product number	Applicable tubing outer diameter (mm)	T Thread size (R)	L ₁ (mm)	L ₂ (mm)	L ₃ (mm)	L ₄ (mm)	L ₁₁ (mm)	A (mm)	F Tubing insertion length (mm)	H×φ Width across flat (mm)	P ₃ (mm)	P ₄ (mm)	W (mm)	D (mm)	d ₁ (mm)	d ₂ (mm)	Effective sectional area (mm ²)	Weight (g)
ELY6-PT1/8	6	R1/8	25.6	25.2	32.1	31.5	24.8	8.0	15	12.0×13.0	14.8	12.2	12.6	12.6	5.0	4.2	—	16.0
ELY6-PT1/4	6	R1/4	25.6	29.2	33.3	35.5	24.8	11.0	15	14.0×15.4	14.8	12.2	12.6	12.6	7.0	4.2	—	23.0
ELY8-PT1/8	8	R1/8	28.2	26.2	35.9	33.5	28.8	8.0	16	14.0×15.4	16.4	14.2	14.6	14.6	5.0	4.2	—	21.0
ELY8-PT1/4	8	R1/4	28.2	30.2	35.9	37.5	28.8	11.0	16	14.0×15.4	16.4	14.2	14.6	14.6	7.0	4.2	—	27.0
ELY8-PT3/8	8	R3/8	28.2	31.2	37.5	38.5	28.8	12.0	16	17.0×18.5	16.4	14.2	14.6	14.6	9.0	4.2	—	35.0
ELY10-PT1/4	10	R1/4	31.3	33.2	40.5	42.0	35.0	11.0	19	17.0×18.5	18.4	17.5	17.5	17.5	7.0	4.2	—	37.0
ELY10-PT3/8	10	R3/8	31.3	34.2	40.5	43.0	35.0	12.0	19	17.0×18.5	18.4	17.5	17.5	17.5	9.0	4.2	—	43.0

Universal branch elbow

●Millimeter size type

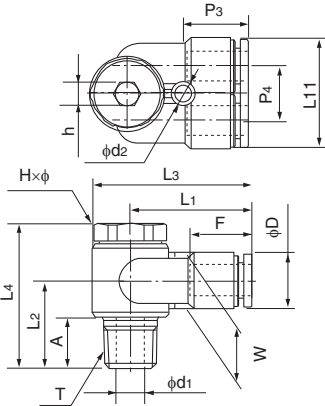

Product number	Applicable tubing outer diameter (mm)	T Thread size (R)	L ₁ (mm)	L ₂ (mm)	L ₃ (mm)	L ₄ (mm)	L ₁₁ (mm)	A (mm)	F Tubing insertion length (mm)	H×φ Width across flat (mm)	h Width across flat (mm)	P ₃ (mm)	P ₄ (mm)	W (mm)	D (mm)	d ₁ (mm)	d ₂ (mm)	Effective sectional area (mm ²)	Weight (g)
ELYB6-PT1/8	6	R1/8	26.1	17.5	33.1	30.0	24.8	9.5	15	13.0×14.0	5.0	14.8	12.2	12.6	12.6	5.0	4.2	—	25.0
ELYB6-PT1/4	6	R1/4	29.0	22.9	38.7	37.5	24.8	13.4	15	17.0×18.3	6.0	14.8	12.2	12.6	12.6	7.0	4.2	—	46.0
ELYB8-PT1/4	8	R1/4	30.6	22.9	40.3	37.5	28.8	13.4	16	17.0×18.3	6.0	16.4	14.2	14.6	14.6	7.0	4.2	—	49.0
ELYB8-PT3/8	8	R3/8	32.9	24.4	44.9	40.5	28.8	13.9	16	21.0×22.6	8.0	16.4	14.2	14.6	14.6	9.0	4.2	—	58.0
ELYB10-PT1/4	10	R1/4	34.9	23.4	46.9	39.5	35.0	12.9	19	21.0×22.6	8.0	18.4	17.5	17.5	17.5	7.0	4.2	—	78.0
ELYB10-PT3/8	10	R3/8	34.9	24.4	46.9	40.5	35.0	13.9	19	21.0×22.6	8.0	18.4	17.5	17.5	17.5	9.0	4.2	—	80.0

Double universal elbow

●Millimeter size type

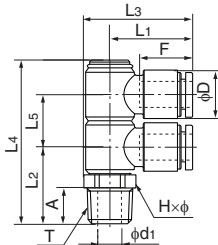

Product number	Applicable tubing outer diameter (mm)	T Thread size (R)	L ₁ (mm)	L ₂ (mm)	L ₃ (mm)	L ₄ (mm)	L ₅ (mm)	A (mm)	F Tubing insertion length (mm)	H×φ Width across flat (mm)	D (mm)	d ₁ (mm)	Effective sectional area (mm ²)	Weight (g)
ELWB6-PT1/8	6	R1/8	22.8	18.8	30.5	42.3	13.5	8.0	15	14.0×15.4	12.6	5.0	—	33.0
ELWB6-PT1/4	6	R1/4	22.8	21.8	30.5	45.3	13.5	11.0	15	14.0×15.4	12.6	7.0	—	35.0
ELWB8-PT1/4	8	R1/4	24.4	23.0	32.1	50.0	16.0	11.0	16	14.0×15.4	14.6	7.0	—	39.0
ELWB8-PT3/8	8	R3/8	24.4	24.0	33.7	51.0	16.0	12.0	16	17.0×18.5	14.6	9.0	—	47.0
ELWB10-PT1/4	10	R1/4	29.4	24.5	39.1	56.0	19.0	11.0	19	17.0×18.5	17.5	7.0	—	72.0
ELWB10-PT3/8	10	R3/8	29.4	25.5	39.1	57.0	19.0	12.0	19	17.0×18.5	17.5	9.0	—	70.0

Tubing
Clean tubing
Processed tubing
PushOne fitting
QuickSeal fitting
Clean fitting/Chemifit
Bamboo-shoot fitting
Control switch/Detachable series
Jig/Tool/Accessory
Technical information
Reference

Triple universal elbow

●Millimeter size type



Product number	Applicable tubing outer diameter (mm)	T Thread size (R)	L ₁ (mm)	L ₂ (mm)	L ₃ (mm)	L ₄ (mm)	L ₅ (mm)	A (mm)	F Tubing insertion length (mm)	H×φ Width across flat (mm)	D (mm)	d ₁ (mm)	Effective sectional area (mm ²)	Weight (g)
ELTB6-PT1/8	6	R1/8	22.8	18.8	30.5	55.5	13.5	8.0	15	14.0×15.4	12.6	5.0	—	43.0
ELTB6-PT1/4	6	R1/4	22.8	21.8	30.5	58.5	13.5	11.0	15	14.0×15.4	12.6	7.0	—	45.0
ELTB8-PT1/4	8	R1/4	24.4	23.0	32.1	66.0	16.0	11.0	16	14.0×15.4	14.6	7.0	—	51.0
ELTB8-PT3/8	8	R3/8	24.4	24.0	33.7	67.0	16.0	12.0	16	17.0×18.5	14.6	9.0	—	59.0
ELTB10-PT1/4	10	R1/4	29.4	24.5	39.1	75.5	19.0	11.0	19	17.0×18.5	17.5	7.0	—	98.0
ELTB10-PT3/8	10	R3/8	29.4	25.5	39.1	76.5	19.0	12.0	19	17.0×18.5	17.5	9.0	—	92.0

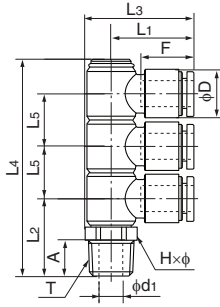

Tee

●Millimeter size type



Product number	Applicable tubing outer diameter (mm)	T Thread size (M,R)	L ₁ (mm)	L ₂ (mm)	L ₄ (mm)	L ₅ (mm)	A (mm)	F Tubing insertion length (mm)	H×φ Width across flat (mm)	D (mm)	d ₁ (mm)	Min. inner diameter (mm)	Effective sectional area (mm ²)	Weight (g)
ET4-M5	4	M5×0.8	17.2	20.2	25.1	34.4	4.0	13	10.0×11.0	9.8	2.0	2.0	3.0	8.0
ET4-PT1/8	4	R1/8	17.2	22.7	27.6	34.4	8.0	13	10.0×11.0	9.8	5.0	3.0	4.0	10.0
ET4-PT1/4	4	R1/4	17.2	26.7	31.6	34.4	11.0	13	14.0×15.4	9.8	7.0	3.0	4.0	17.0
ET6-M5	6	M5×0.8	18.5	22.7	29.0	37.0	4.0	15	12.0×13.0	12.6	2.0	2.0	3.5	12.0
ET6-PT1/8	6	R1/8	18.5	25.2	31.5	37.0	8.0	15	12.0×13.0	12.6	5.0	4.6	12.0	14.0
ET6-PT1/4	6	R1/4	18.5	29.2	35.5	37.0	11.0	15	14.0×15.4	12.6	7.0	4.6	12.0	21.0
ET6-PT3/8	6	R3/8	18.5	30.2	36.5	37.0	12.0	15	17.0×18.5	12.6	9.0	4.6	12.0	29.0
ET8-PT1/8	8	R1/8	20.7	26.2	33.5	41.4	8.0	16	14.0×15.4	14.6	5.0	5.0	18.5	18.0
ET8-PT1/4	8	R1/4	20.7	30.2	37.5	41.4	11.0	16	14.0×15.4	14.6	7.0	7.0	23.0	24.0
ET8-PT3/8	8	R3/8	20.7	31.2	38.5	41.4	12.0	16	17.0×18.5	14.6	9.0	7.0	23.0	32.0
ET10-PT1/8	10	R1/8	24.7	29.2	38.0	49.3	8.0	19	17.0×18.5	17.5	5.0	5.0	22.0	28.0
ET10-PT1/4	10	R1/4	24.7	33.2	42.0	49.3	11.0	19	17.0×18.5	17.5	7.0	7.0	34.5	34.0
ET10-PT3/8	10	R3/8	24.7	34.2	43.0	49.3	12.0	19	17.0×18.5	17.5	9.0	9.0	37.0	39.0
ET10-PT1/2	10	R1/2	24.7	38.2	47.0	49.3	15.0	19	22.0×24.5	17.5	12.0	9.0	37.0	58.0
ET12-PT1/4	12	R1/4	26.3	35.7	45.7	52.6	11.0	20	19.0×21.0	20.0	7.0	7.0	36.0	43.0
ET12-PT3/8	12	R3/8	26.3	36.7	46.7	52.6	12.0	20	19.0×21.0	20.0	9.0	9.0	43.0	48.0
ET12-PT1/2	12	R1/2	26.3	40.7	50.7	52.6	15.0	20	22.0×24.5	20.0	12.0	10.0	43.0	65.0
ET16-PT3/8	16	R3/8	34.9	45.0	59.0	69.8	12.0	27	24.0×27.0	28.0	11.0	11.0	70.0	92.0
ET16-PT1/2	16	R1/2	34.9	48.0	62.0	69.8	15.0	27	24.0×27.0	28.0	12.0	12.0	93.0	106.0

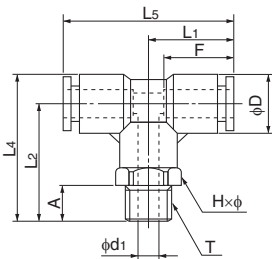

M thread

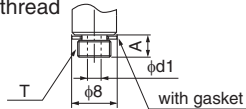

●Inch size type

Product number	Applicable tubing outer diameter (inch)	T Thread size (M,R)	L ₁ (mm)	L ₂ (mm)	L ₄ (mm)	L ₅ (mm)	A (mm)	F Tubing insertion length (mm)	H×φ Width across flat (mm)	D (mm)	d ₁ (mm)	Min. inner diameter (mm)	Effective sectional area (mm ²)	Weight (g)
ET1/4-PT1/8	1/4	R1/8	18.1	25.2	31.7	36.2	8.0	15	12.0×13.0	13.0	5.0	4.6	13.0	14.0
ET1/4-PT1/4	1/4	R1/4	18.1	29.2	35.7	36.2	11.0	15	14.0×15.4	13.0	7.0	4.6	13.0	21.0
ET5/16-PT1/8	5/16	R1/8	20.6	26.2	33.7	41.2	8.0	16	14.0×15.4	15.0	5.0	5.0	18.5	18.0
ET5/16-PT1/4	5/16	R1/4	20.6	30.2	37.7	41.2	11.0	16	14.0×15.4	15.0	7.0	7.0	23.0	24.0
ET5/16-PT3/8	5/16	R3/8	20.6	31.2	38.7	41.2	12.0	16	17.0×18.5	15.0	9.0	7.0	—	—
ET3/8-PT1/4	3/8	R1/4	24.4	33.2	42.2	48.8	11.0	19	17.0×18.5	18.0	7.0	7.0	30.0	34.0
ET3/8-PT3/8	3/8	R3/8	24.4	34.2	43.2	48.8	12.0	19	17.0×18.5	18.0	9.0	9.0	32.0	39.0
ET3/8-PT1/2	3/8	R1/2	24.4	38.2	47.2	48.8	15.0	19	22.0×24.5	18.0	12.0	9.0	32.0	58.0
ET1/2-PT3/8	1/2	R3/8	27.5	37.0	47.8	54.9	12.0	21	19.0×21.0	21.5	9.0	9.0	53.0	48.0
ET1/2-PT1/2	1/2	R1/2	27.5	41.0	51.8	54.9	15.0	21	22.0×24.5	21.5	12.0	10.0	55.5	65.0

☞ The inch size type is not plated.

Service tee

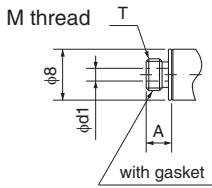
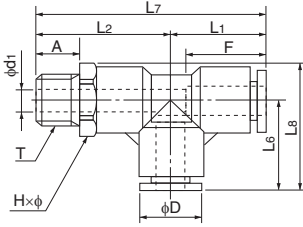

●Millimeter size type

Product number	Applicable tubing outer diameter (mm)	T Thread size (M,R)	L ₁ (mm)	L ₂ (mm)	L ₃ (mm)	L ₄ (mm)	L ₅ (mm)	A (mm)	F Tubing insertion length (mm)	H×φ Width across flat (mm)	D (mm)	d ₁ (mm)	Min. inner diameter (mm)	Effective sectional area (mm ²)	Weight (g)
EST4-M5	4	M5×0.8	17.2	20.2	17.2	37.4	22.7	4.0	13	10.0×11.0	9.8	2.0	2.0	3.0	8.0
EST4-PT1/8	4	R1/8	17.2	22.7	17.2	39.9	22.7	8.0	13	10.0×11.0	9.8	5.0	3.0	4.0	10.0
EST4-PT1/4	4	R1/4	17.2	26.7	17.2	43.9	24.9	11.0	13	14.0×15.4	9.8	7.0	3.0	4.0	18.0
EST6-M5	6	M5×0.8	18.5	22.7	18.5	41.2	25.0	4.0	15	12.0×13.0	12.6	2.0	2.0	3.5	12.0
EST6-PT1/8	6	R1/8	18.5	25.2	18.5	43.7	25.0	8.0	15	12.0×13.0	12.6	5.0	5.0	12.0	14.0
EST6-PT1/4	6	R1/4	18.5	29.2	18.5	47.7	26.2	11.0	15	14.0×15.4	12.6	7.0	5.0	12.0	21.0
EST6-PT3/8	6	R3/8	18.5	30.2	18.5	48.7	27.8	12.0	15	17.0×18.5	12.6	9.0	5.0	12.0	29.0
EST8-PT1/8	8	R1/8	20.7	26.2	20.7	46.9	28.4	8.0	16	14.0×15.4	14.6	5.0	5.0	18.5	18.0
EST8-PT1/4	8	R1/4	20.7	30.2	20.7	50.9	28.4	11.0	16	14.0×15.4	14.6	7.0	7.0	23.0	24.0
EST8-PT3/8	8	R3/8	20.7	31.2	20.7	51.9	30.0	12.0	16	17.0×18.5	14.6	9.0	7.0	23.0	32.0
EST10-PT1/8	10	R1/8	24.7	29.2	24.7	53.9	33.9	8.0	19	17.0×18.5	17.5	5.0	5.0	22.0	28.0
EST10-PT1/4	10	R1/4	24.7	33.2	24.7	57.9	33.9	11.0	19	17.0×18.5	17.5	7.0	7.0	34.5	34.0
EST10-PT3/8	10	R3/8	24.7	34.2	24.7	58.9	33.9	12.0	19	17.0×18.5	17.5	9.0	9.0	37.0	40.0
EST10-PT1/2	10	R1/2	24.7	38.2	24.7	62.9	36.9	15.0	19	22.0×24.5	17.5	12.0	9.0	37.0	58.0
EST12-PT1/4	12	R1/4	26.3	35.7	26.3	62.0	36.8	11.0	20	19.0×21.0	20.0	7.0	7.0	36.0	43.0
EST12-PT3/8	12	R3/8	26.3	36.7	26.3	63.0	36.8	12.0	20	19.0×21.0	20.0	9.0	9.0	43.0	48.0
EST12-PT1/2	12	R1/2	26.3	40.7	26.3	67.0	38.6	15.0	20	22.0×24.5	20.0	12.0	10.0	43.0	65.0
EST16-PT3/8	16	R3/8	34.9	45.0	34.9	79.9	48.4	12.0	27	24.0×27.0	28.0	11.0	11.0	70.0	92.0
EST16-PT1/2	16	R1/2	34.9	48.0	34.9	82.9	48.4	15.0	27	24.0×27.0	28.0	12.0	12.0	93.0	106.0

●Inch size type

Product number	Applicable tubing outer diameter (inch)	T Thread size (R)	L ₁ (mm)	L ₂ (mm)	L ₃ (mm)	L ₄ (mm)	L ₅ (mm)	A (mm)	F Tubing insertion length (mm)	H×φ Width across flat (mm)	D (mm)	d ₁ (mm)	Min. inner diameter (mm)	Effective sectional area (mm ²)	Weight (g)
EST1/4-PT1/8	1/4	R1/8	18.1	25.2	18.1	43.3	24.6	8.0	15	12.0×13.0	13.0	5.0	5.0	13.0	14.0
EST1/4-PT1/4	1/4	R1/4	18.1	29.2	18.1	47.3	25.8	11.0	15	14.0×15.4	13.0	7.0	5.0	13.0	21.0
EST5/16-PT1/8	5/16	R1/8	20.6	26.2	20.6	46.8	28.3	8.0	16	14.0×15.4	15.0	5.0	5.0	18.5	18.0
EST5/16-PT1/4	5/16	R1/4	20.6	30.2	20.6	50.8	28.3	11.0	16	14.0×15.4	15.0	7.0	7.0	23.0	24.0
EST5/16-PT3/8	5/16	R3/8	20.6	31.2	20.6	51.8	29.9	12.0	16	17.0×18.5	15.0	9.0	7.0	—	—
EST3/8-PT1/4	3/8	R1/4	24.4	33.2	24.4	57.6	33.7	11.0	19	17.0×18.5	18.0	7.0	7.0	30.0	34.0
EST3/8-PT3/8	3/8	R3/8	24.4	34.2	24.4	58.6	33.7	12.0	19	17.0×18.5	18.0	9.0	9.0	32.0	40.0
EST3/8-PT1/2	3/8	R1/2	24.4	38.2	24.4	62.6	36.7	15.0	19	22.0×24.5	18.0	12.0	9.0	32.0	58.0
EST1/2-PT3/8	1/2	R3/8	27.5	37.0	27.5	64.5	38.0	12.0	21	19.0×21.0	21.5	9.0	9.0	53.0	48.0
EST1/2-PT1/2	1/2	R1/2	27.5	41.0	27.5	68.5	39.7	15.0	21	22.0×24.5	21.5	12.0	10.0	55.5	65.0

☞ The inch size type is not plated.

Tubing
Clean tubing
Processed tubing
PushOne fitting
QuickSeal fitting
Clean fitting/Chemifit
Bamboo-shoot fitting
Control switch/Detachable series
Jig/Tool/Accessory
Technical information
Reference

Y joint

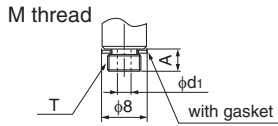
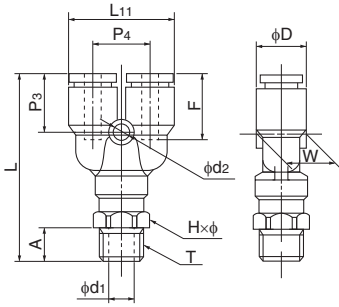

●Millimeter size type

Product number	Applicable tubing outer diameter (mm)	T Thread size (M,R)	L (mm)	L ₁₁ (mm)	A (mm)	F Tubing insertion length (mm)	H×φ Width across flat (mm)	P ₃ (mm)	P ₄ (mm)	W (mm)	D (mm)	d ₁ (mm)	d ₂ (mm)	Min. inner diameter (mm)	Effective sectional area (mm ²)	Weight (g)
EY4-M5	4	M5×0.8	37.9	20.8	4.0	13	10.0×11.0	13.4	11.0	9.8	9.8	2.0	3.2	2.0	2.5	9.0
EY4-PT1/8	4	R1/8	40.4	20.8	8.0	13	10.0×11.0	13.4	11.0	9.8	9.8	5.0	3.2	3.0	3.5	11.0
EY4-PT1/4	4	R1/4	44.4	20.8	11.0	13	14.0×15.4	13.4	11.0	9.8	9.8	7.0	3.2	3.0	3.5	18.0
EY6-M5	6	M5×0.8	41.3	24.8	4.0	15	12.0×13.0	14.8	12.2	12.5	12.6	2.0	4.2	2.0	2.5	13.0
EY6-PT1/8	6	R1/8	43.8	24.8	8.0	15	12.0×13.0	14.8	12.2	12.5	12.6	5.0	4.2	5.0	9.0	15.0
EY6-PT1/4	6	R1/4	47.8	24.8	11.0	15	14.0×15.4	14.8	12.2	12.5	12.6	7.0	4.2	5.0	9.0	22.0
EY6-PT3/8	6	R3/8	48.8	24.8	12.0	15	17.0×18.5	14.8	12.2	12.5	12.6	9.0	4.2	5.0	9.0	30.0
EY8-PT1/8	8	R1/8	46.9	28.8	8.0	16	14.0×15.4	16.4	14.2	14.6	14.6	5.0	4.2	5.0	17.5	20.0
EY8-PT1/4	8	R1/4	50.9	28.8	11.0	16	14.0×15.4	16.4	14.2	14.6	14.6	7.0	4.2	7.0	20.0	25.0
EY8-PT3/8	8	R3/8	51.9	28.8	12.0	16	17.0×18.5	16.4	14.2	14.6	14.6	9.0	4.2	7.0	20.0	33.0
EY10-PT1/4	10	R1/4	55.9	35.0	11.0	19	17.0×18.5	18.4	17.5	17.5	17.5	7.0	4.2	7.0	27.5	33.0
EY10-PT3/8	10	R3/8	56.9	35.0	12.0	19	17.0×18.5	18.4	17.5	17.5	17.5	9.0	4.2	9.0	28.0	41.0
EY10-PT1/2	10	R1/2	60.9	35.0	15.0	19	22.0×24.5	18.4	17.5	17.5	17.5	12.0	4.2	9.0	28.0	60.0
EY12-PT1/4	12	R1/4	60.8	40.0	11.0	20	19.0×21.0	20.3	20.0	20.0	20.0	7.0	4.2	7.0	34.5	47.0
EY12-PT3/8	12	R3/8	61.8	40.0	12.0	20	19.0×21.0	20.3	20.0	20.0	20.0	9.0	4.2	9.0	40.0	52.0
EY12-PT1/2	12	R1/2	65.8	40.0	15.0	20	22.0×24.5	20.3	20.0	20.0	20.0	12.0	4.2	10.0	40.0	70.0
EY16-PT3/8	16	R3/8	78.6	55.5	12.0	27	24.0×27.0	26.6	27.5	27.5	28.0	11.0	4.2	11.0	70.0	103.0
EY16-PT1/2	16	R1/2	81.6	55.5	15.0	27	24.0×27.0	26.6	27.5	27.5	28.0	12.0	4.2	12.0	71.0	117.0

●Inch size type

Product number	Applicable tubing outer diameter (inch)	T Thread size (R)	L (mm)	L ₁₁ (mm)	A (mm)	F Tubing insertion length (mm)	H×φ Width across flat (mm)	P ₃ (mm)	P ₄ (mm)	W (mm)	D (mm)	d ₁ (mm)	d ₂ (mm)	Min. inner diameter (mm)	Effective sectional area (mm ²)	Weight (g)
EY1/4-PT1/8	1/4	R1/8	43.4	25.2	8.0	15	12.0×13.0	14.4	12.2	12.5	13.0	5.0	4.2	5.0	10.5	15.0
EY1/4-PT1/4	1/4	R1/4	47.4	25.2	11.0	15	14.0×15.4	14.4	12.2	12.5	13.0	7.0	4.2	5.0	10.5	22.0
EY5/16-PT1/8	5/16	R1/8	46.8	29.2	8.0	16	14.0×15.4	16.3	14.2	14.5	15.0	5.0	4.2	5.0	17.5	20.0
EY5/16-PT1/4	5/16	R1/4	50.8	29.2	11.0	16	14.0×15.4	16.3	14.2	14.5	15.0	7.0	4.2	7.0	20.0	25.0
EY5/16-PT3/8	5/16	R3/8	51.8	29.2	12.0	16	17.0×18.5	16.3	14.2	14.5	15.0	9.0	4.2	7.0	—	—
EY3/8-PT1/4	3/8	R1/4	55.6	35.5	11.0	19	17.0×18.5	18.1	17.5	17.5	18.0	7.0	4.2	7.0	26.0	33.0
EY3/8-PT3/8	3/8	R3/8	56.6	35.5	12.0	19	17.0×18.5	18.1	17.5	17.5	18.0	9.0	4.2	9.0	26.0	41.0
EY1/2-PT1/4	1/2	R1/4	62.5	42.5	11.0	21	19.0×21.0	20.5	21.0	21.0	21.5	7.0	4.2	7.0	37.0	47.0
EY1/2-PT3/8	1/2	R3/8	63.5	42.5	12.0	21	19.0×21.0	20.5	21.0	21.0	21.5	9.0	4.2	9.0	48.0	52.0
EY1/2-PT1/2	1/2	R1/2	67.5	42.5	15.0	21	22.0×24.5	20.5	21.0	21.0	21.5	12.0	4.2	11.0	48.0	70.0

↳ The inch size type is not plated.

Union connector

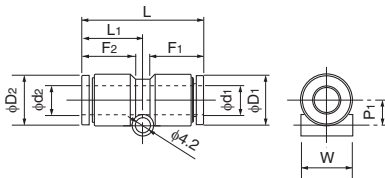

●Millimeter size type

Product number	d ₁ Applicable tubing outer diameter (mm)	d ₂ Applicable tubing outer diameter (mm)	L (mm)	L ₁ (mm)	P ₁ (mm)	F ₁ Tubing insertion length (mm)	F ₂ Tubing insertion length (mm)	D ₁ (mm)	D ₂ (mm)	W (mm)	Min. inner diameter (mm)	Effective sectional area (mm ²)	Weight (g)
EUC4	4	4	31.8	15.9	5.0	13	13	9.8	9.8	9.7	3.0	3.5	4.0
EUC4-6	4	6	32.7	16.8	6.0	13	15	9.8	12.6	12.5	3.0	3.5	5.0
EUC6	6	6	33.6	16.8	6.0	15	15	12.6	12.6	12.5	5.0	12.5	6.0
EUC6-8	6	8	34.7	17.9	7.0	15	16	12.6	14.6	14.5	5.0	11.5	7.0
EUC8	8	8	35.8	17.9	7.0	16	16	14.6	14.6	14.5	7.0	28.0	8.0
EUC8-10	8	10	38.8	20.9	8.5	16	19	14.6	17.5	17.5	7.0	31.5	11.0
EUC10	10	10	41.7	20.9	8.5	19	19	17.5	17.5	17.5	9.0	45.0	14.0
EUC10-12	10	12	42.7	21.8	9.8	19	20	17.5	20.0	20.0	9.0	53.0	17.0
EUC12	12	12	43.6	21.8	9.8	20	20	20.0	20.0	20.0	11.0	67.0	19.0
EUC16	16	16	56.2	28.1	13.8	27	27	28.0	28.0	27.5	13.0	110.0	48.0

●Inch size type

Product number	d ₁ Applicable tubing outer diameter (inch)	d ₂ Applicable tubing outer diameter (inch)	L (mm)	L ₁ (mm)	P ₁ (mm)	F ₁ Tubing insertion length (mm)	F ₂ Tubing insertion length (mm)	D ₁ (mm)	D ₂ (mm)	W (mm)	Min. inner diameter (mm)	Effective sectional area (mm ²)	Weight (g)
EUC1/4	1/4	1/4	32.8	16.4	6.0	15	15	13.0	13.0	12.5	5.0	12.5	6.0
EUC5/16	5/16	5/16	35.6	17.8	7.0	16	16	15.0	15.0	14.5	7.0	28.0	8.0
EUC3/8	3/8	3/8	41.2	20.6	8.5	19	19	18.0	18.0	17.5	9.0	35.0	14.0
EUC1/2	1/2	1/2	43.9	22.0	10.3	21	21	21.5	21.5	21.0	11.0	65.0	19.0

↳ The inch size type is not plated.

Tubing

Clean tubing

Processed tubing

PushOne fitting

QuickSeal fitting

Clean fitting/Chemfit

Bamboo-shoot fitting

Control switch/Detachable series

Jig/Tool/Accessory

Technical information

Reference

90 degree union elbow

●Millimeter size type



Product number	Applicable tubing outer diameter (mm)	L ₁ (mm)	L ₈ (mm)	P ₁ (mm)	F Tubing insertion length (mm)	D (mm)	W (mm)	Min. inner diameter (mm)	Effective sectional area (mm ²)	Weight (g)
EUL4	4	17.2	22.1	6.9	13	9.8	9.7	3.0	3.5	4.0
EUL6	6	18.5	24.8	8.3	15	12.6	12.5	5.0	9.5	6.0
EUL8	8	20.7	28.0	9.3	16	14.6	14.5	7.0	19.5	9.0
EUL10	10	24.7	33.4	10.8	19	17.5	17.5	9.0	32.5	15.0
EUL12	12	26.3	36.3	12.1	20	20.0	20.0	11.0	45.5	20.0

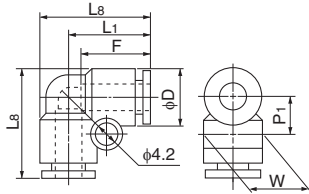

Product number	Applicable tubing outer diameter (mm)	L ₁ (mm)	L ₈ (mm)	L ₁₂ (mm)	P ₁ (mm)	F Tubing insertion length (mm)	D (mm)	W (mm)	Min. inner diameter (mm)	Effective sectional area (mm ²)	Weight (g)
EUL16	16	34.9	48.9	50.8	12.9	27	28.0	27.5	13.0	97.5	50.0
EULL16	16	34.9	48.9	61.5	12.9	27	28.0	27.5	13.0	96.5	56.0

*EUL16 and EULL16 have a different screw hole position.
*EULL16 is made to order.

●Inch size type

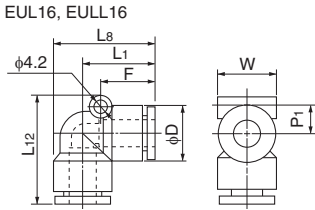

Product number	Applicable tubing outer diameter (inch)	L ₁ (mm)	L ₈ (mm)	P ₁ (mm)	F Tubing insertion length (mm)	D (mm)	W (mm)	Min. inner diameter (mm)	Effective sectional area (mm ²)	Weight (g)
EUL1/4	1/4	18.1	24.6	8.3	15	13.0	12.5	5.0	12.0	6.0
EUL5/16	5/16	20.6	28.1	9.3	16	15.0	14.5	7.0	20.0	9.0
EUL3/8	3/8	24.4	33.4	10.8	19	18.0	17.5	9.0	27.0	15.0
EUL1/2	1/2	27.5	38.2	12.6	21	21.5	21.0	11.0	54.5	20.0

The inch size type is not plated.

90 degree branch union elbow

●Millimeter size type



Product number	Applicable tubing outer diameter (mm)	L ₁ (mm)	L ₂ (mm)	L ₃ (mm)	L ₄ (mm)	L ₁₁ (mm)	F Tubing insertion length (mm)	P ₃ (mm)	P ₄ (mm)	W (mm)	D (mm)	d ₂ (mm)	Min. inner diameter (mm)	Effective sectional area (mm ²)	Weight (g)
EULY6	6	25.6	18.0	31.9	24.3	24.8	15	14.8	12.2	12.6	12.6	4.2	5.0	—	10.0
EULY8	8	28.2	19.6	35.5	26.9	28.8	16	16.4	14.2	14.6	14.6	4.2	7.0	—	14.0
EULY10	10	31.3	22.6	40.0	31.3	35.0	19	18.4	17.5	17.5	17.5	4.2	9.0	—	23.0

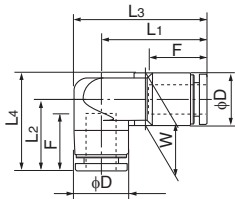
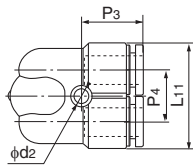

Union tee

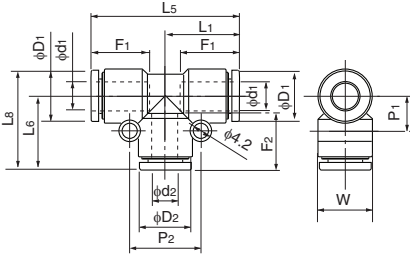

●Millimeter size type

Product number	d1 Applicable tubing outer diameter (mm)	d2 Applicable tubing outer diameter (inch)	L1 (mm)	L5 (mm)	L6 (mm)	L8 (mm)	F1 Tubing insertion length (mm)	F2 Tubing insertion length (mm)	P1 (mm)	P2 (mm)	D1 (mm)	D2 (mm)	W (mm)	Min. inner diameter (mm)	Effective sectional area (mm ²)	Weight (g)
EUT4	4	4	17.2	34.4	17.2	22.1	13	13	6.9	14.0	9.8	9.8	9.7	3.0	3.5	6.0
EUT4-6	4	6	17.7	35.4	18.0	22.9	13	15	6.8	17.0	9.8	12.6	12.5	3.0	2.5	8.0
EUT6	6	6	18.5	37.0	18.5	24.8	15	15	8.3	17.0	12.6	12.6	12.5	5.0	4.5	9.0
EUT6-8	6	8	19.5	39.0	20.4	26.7	15	16	8.2	19.0	12.6	14.6	14.5	5.0	15.5	11.0
EUT8	8	8	20.7	41.4	20.7	28.0	16	16	9.3	19.0	14.6	14.6	14.5	7.0	19.5	13.0
EUT8-10	8	10	21.7	43.4	24.4	31.7	16	19	9.2	22.0	14.6	17.5	17.5	7.0	21.0	18.0
EUT10	10	10	24.7	49.3	24.7	33.4	19	19	10.8	22.0	17.5	17.5	17.5	9.0	32.5	22.0
EUT10-12	10	12	25.6	51.1	26.3	35.1	19	20	10.8	24.0	17.5	20.0	20.0	9.0	27.0	26.0
EUT12	12	12	26.3	52.6	26.3	36.3	20	20	12.1	24.0	20.0	20.0	20.0	11.0	45.5	29.0
EUT16	16	16	34.9	69.8	34.9	48.9	27	27	15.9	31.7	28.0	28.0	27.5	13.0	97.0	73.0

●Inch size type

Product number	d1 Applicable tubing outer diameter (mm)	d2 Applicable tubing outer diameter (inch)	L1 (mm)	L5 (mm)	L6 (mm)	L8 (mm)	F1 Tubing insertion length (mm)	F2 Tubing insertion length (mm)	P1 (mm)	P2 (mm)	D1 (mm)	D2 (mm)	W (mm)	Min. inner diameter (mm)	Effective sectional area (mm ²)	Weight (g)
EUT1/4	1/4	1/4	18.1	36.2	18.1	24.6	15	15	8.3	17.0	13.0	13.0	12.5	5.0	12.0	9.0
EUT5/16	5/16	5/16	20.6	41.2	20.6	28.1	16	16	9.3	19.0	15.0	15.0	14.5	7.0	20.0	13.0
EUT3/8	3/8	3/8	24.4	48.8	24.4	33.4	19	19	10.8	22.0	18.0	18.0	17.5	9.0	27.0	22.0
EUT1/2	1/2	1/2	27.5	54.9	27.5	38.2	21	21	12.6	25.0	21.5	21.5	21.0	11.0	54.5	29.0

☞ The inch size type is not plated.

Y union

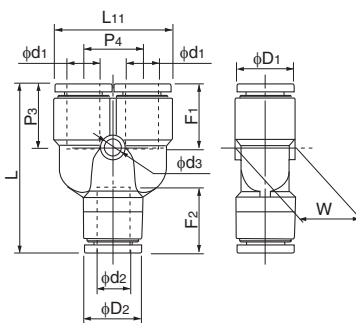

●Millimeter size type

Product number	d1 Applicable tubing outer diameter (mm)	d2 Applicable tubing outer diameter (inch)	L (mm)	L11 (mm)	F1 Tubing insertion length (mm)	F2 Tubing insertion length (mm)	P3 (mm)	P4 (mm)	W (mm)	D1 (mm)	D2 (mm)	d3 (mm)	Min. inner diameter (mm)	Effective sectional area (mm ²)	Weight (g)
EYB4-4	4	4	33.8	20.8	13	13	13.4	11.0	9.8	9.8	9.8	3.2	3.0	3.0	6.0
EYB4-6	4	6	34.2	20.8	13	15	13.4	11.0	12.5	9.8	12.6	3.2	3.0	2.5	8.0
EYB6-6	6	6	37.5	24.8	15	15	14.8	12.2	12.5	12.6	12.6	4.2	5.0	8.0	10.0
EYB6-8	6	8	39.2	24.8	15	16	14.8	12.2	14.5	12.6	14.6	4.2	5.0	17.0	12.0
EYB8-8	8	8	42.9	28.8	16	16	16.4	14.2	14.6	14.6	14.6	4.2	7.0	18.0	14.0
EYB8-10	8	10	44.8	28.8	16	19	16.4	14.2	17.5	14.6	17.5	4.2	7.0	22.5	19.0
EYB10-10	10	10	48.3	35.0	19	19	18.4	17.5	17.5	17.5	17.5	4.2	9.0	27.0	24.0
EYB10-12	10	12	49.4	35.0	19	20	18.4	17.5	20.0	17.5	20.0	4.2	9.0	30.0	29.0
EYB12-12	12	12	54.0	40.0	20	20	20.3	20.0	20.0	20.0	20.0	4.2	11.0	38.5	33.0

●Inch size type

Product number	d1 Applicable tubing outer diameter (mm)	d2 Applicable tubing outer diameter (inch)	L (mm)	L11 (mm)	F1 Tubing insertion length (mm)	F2 Tubing insertion length (mm)	P3 (mm)	P4 (mm)	W (mm)	D1 (mm)	D2 (mm)	d3 (mm)	Min. inner diameter (mm)	Effective sectional area (mm ²)	Weight (g)
EYB1/4	1/4	1/4	36.7	25.2	15	15	14.4	12.2	12.5	13.0	13.0	4.2	5.0	10.5	10.0
EYB5/16	5/16	5/16	42.7	29.2	16	16	16.3	14.2	14.5	15.0	15.0	4.2	7.0	19.5	14.0
EYB3/8	3/8	3/8	47.8	35.5	19	19	18.1	17.5	17.5	18.0	18.0	4.2	9.0	24.0	24.0
EYB1/2	1/2	1/2	55.8	42.5	21	21	20.5	21.0	21.0	21.5	21.5	4.2	11.0	46.5	33.0

☞ The inch size type is not plated.

Tubing

Clean tubing

Processed tubing

PushOne fitting

QuickSeal fitting

Clean fitting/ Chemifit

Bamboo-shoot fitting

Control switch/ Detachable series

Jig/Tool/ Accessory

Technical information

Reference

Double Y union

●Millimeter size type



Product number	d1 Applicable tubing outer diameter (mm)	d2 Applicable tubing outer diameter (mm)	L (mm)	L11 (mm)	F1 Tubing insertion length (mm)	F2 Tubing insertion length (mm)	P3 (mm)	P4 (mm)	W (mm)	D1 (mm)	D (mm)	ds (mm)	Min. inner diameter (mm)	Effective sectional area (mm ²)	Weight (g)
EUWY4-6	4	6	34.2	19.8	13	15	13.4	10.0	19.8	9.8	12.6	3.2	3.5	—	10.0
EUWY6-8	6	8	39.2	24.8	15	16	14.8	12.2	24.8	12.6	14.6	4.2	5.0	—	16.0

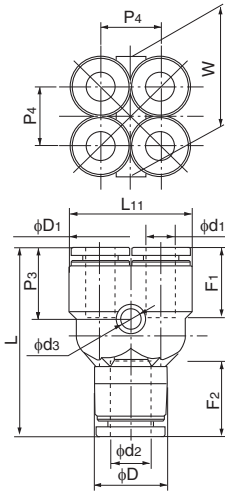

Panel touch connector

●Millimeter size type



Product number	Applicable tubing outer diameter (mm)	L (mm)	F Tubing insertion length (mm)	t Max. panel thickness (mm)	H4 (mm)	T1 Recommended panel hole diameter (mm)	Washer outer diameter (mm)	Washer thickness (mm)	Thread length (mm)	Min. inner diameter (mm)	Effective sectional area (mm ²)	Weight (g)
EPC4	4	31.8	13	8.0	17.0	13	20	2.0	20	3.0	3.5	5.0
EPC6	6	33.6	15	9.5	19.0	15	24	2.5	22	5.0	12.5	7.0
EPC8	8	35.8	16	10.5	22.0	17	28	2.5	23	7.0	28.0	9.0
EPC10	10	41.7	19	14.0	27.0	21	34	3.0	27	9.0	45.0	16.0
EPC12	12	43.6	20	16.0	30.0	23	37	3.0	29	11.0	67.0	67.0

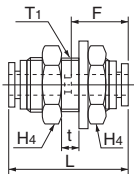

Internal panel touch connector

●Millimeter size type



Product number	Applicable tubing outer diameter (mm)	T Thread size (RC)	L (mm)	A (mm)	F Tubing insertion length (mm)	H×φ Width across flat (mm)	H4 (mm)	t Max. panel thickness (mm)	T1 Recommended panel hole diameter (mm)	d1 (mm)	Washer outer diameter (mm)	Washer thickness (mm)	Min. inner diameter (mm)	Effective sectional area (mm ²)	Weight (g)
EPFC4-PT1/8	4	RC1/8	27.9	8.7	13	17.0×18.5	17.0	8.0	13	3.0	20	2.0	3.0	4.0	22.0
EPFC6-PT1/8	6	RC1/8	29.8	8.7	15	19.0×21.0	19.0	9.0	15	5.0	24	2.5	5.0	10.5	44.0
EPFC6-PT1/4	6	RC1/4	35.3	13.0	15	19.0×21.0	19.0	9.0	15	5.0	24	2.5	5.0	10.5	50.0
EPFC8-PT1/4	8	RC1/4	34.4	13.0	16	22.0×24.5	22.0	10.5	17	7.0	28	2.5	7.0	25.0	64.0
EPFC8-PT3/8	8	RC3/8	38.4	13.5	16	22.0×24.5	22.0	10.5	17	7.0	28	2.5	7.0	26.0	68.0
EPFC10-PT1/4	10	RC1/4	40.4	13.0	19	27.0×30.0	27.0	14.0	21	9.0	34	3.0	9.0	40.0	117.0
EPFC10-PT3/8	10	RC3/8	40.4	13.5	19	27.0×30.0	27.0	14.0	21	9.0	34	3.0	9.0	40.0	107.0
EPFC12-PT1/4	12	RC1/4	42.3	13.0	20	30.0×33.5	30.0	16.0	23	10.5	37	3.0	10.5	45.0	147.0
EPFC12-PT3/8	12	RC3/8	42.3	13.5	20	30.0×33.5	30.0	16.0	23	11.0	37	3.0	11.0	50.0	138.0

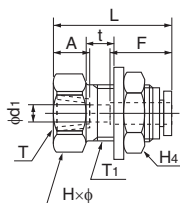

Tubing
Clean tubing
Processed tubing
PushOne fitting
QuickSeal fitting
Clean fitting/ Chemifit
Bamboo-shoot fitting
Control switch/ Detachable series
Jig/Tool/ Accessory
Technical information
Reference

90 degree panel touch elbow

●Millimeter size type



Product number	Applicable tubing outer diameter (mm)	L ₁ (mm)	L ₂ (mm)	L ₃ (mm)	L ₄ (mm)	F Tubing insertion length (mm)	H _{×φ} Width across flat (mm)	H ₄ Width across flat (mm)	t Max. panel thickness (mm)	T ₁ Recommended panel hole diameter (mm)	D (mm)	Washer outer diameter (mm)	Washer thickness (mm)	Min. inner diameter (mm)	Effective sectional area (mm ²)	Weight (g)
EPL4	4	17.2	35.6	27.7	40.5	13	17.0×18.5	17.0	7.5	13	9.8	21	2.5	3.0	—	32.0
EPL6	6	18.5	40.0	30.5	46.3	15	19.0×21.0	19.0	9.0	15	12.6	24	2.5	5.0	—	43.0
EPL8	8	20.7	43.6	34.7	50.9	16	22.0×24.5	22.0	10.0	17	14.6	28	3.0	7.0	—	62.0
EPL10	10	24.7	51.6	41.7	60.3	19	27.0×30.0	27.0	14.0	21	17.5	34	3.0	9.0	—	101.0
EPL12	12	26.3	56.0	44.8	66.0	20	30.0×33.5	30.0	16.0	23	20.0	37	3.0	10.0	—	126.0

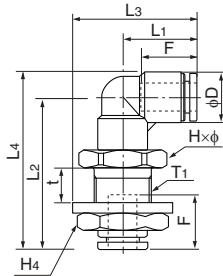

Reducer

●Millimeter size type



Product number	Applicable tubing outer diameter (mm)	D ₁ Insertion part diameter (mm)	L (mm)	L ₁₀ (mm)	F Tubing insertion length (mm)	D (mm)	Min. inner diameter (mm)	Effective sectional area (mm ²)	Weight (g)
ER4-6-Z2	4	6	34.0	17.5	13	9.8	3.0	3.5	3.0
ER4-8-Z2	4	8	31.5	18.5	13	9.8	3.0	3.5	3.0
ER6-8-Z2	6	8	34.3	17.3	15	12.6	5.0	10.5	4.0
ER6-10-Z2	6	10	35.2	20.2	15	12.6	5.0	10.5	4.0
ER6-12-Z2	6	12	36.7	20.9	15	12.6	5.0	10.5	5.0
ER8-10-Z2	8	10	39.0	18.5	16	14.6	7.0	28.0	5.0
ER8-12-Z2	8	12	37.9	15.8	16	14.6	7.0	28.0	5.0
ER10-12-Z2	10	12	42.5	20.5	19	17.5	9.0	45.0	8.0

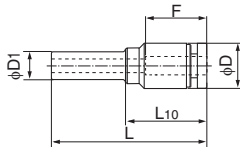

Adapter elbow

●Millimeter size type



Product number	Applicable tubing outer diameter (mm)	D ₁ Insertion part diameter (mm)	L ₁ (mm)	L ₂ (mm)	L ₃ (mm)	L ₄ (mm)	L ₁₀ (mm)	F Tubing insertion length (mm)	D (mm)	Min. inner diameter (mm)	Effective sectional area (mm ²)	Weight (g)
EAL4	4	4	17.2	30.7	22.1	35.6	14.7	13	9.8	3.0	4.0	6.0
EAL6	6	6	18.5	34.2	24.4	40.5	17.7	15	12.6	4.5	12.0	10.0
EAL8	8	8	20.7	35.7	27.6	43.0	18.7	16	14.6	6.0	20.0	14.0
EAL10	10	10	24.7	41.2	33.0	50.0	22.7	19	17.5	8.0	35.0	22.0
EAL12	12	12	26.3	45.2	35.7	55.2	25.2	20	20.0	10.0	43.0	30.0

⚠ Caution: Once an adapter elbow is inserted into a PushOne part, the part cannot be used to connect a tubing.

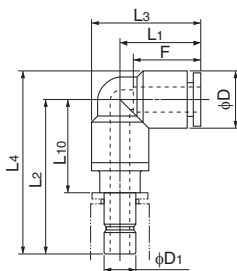

Tubing

Clean tubing

Processed tubing

PushOne fitting

QuickSeal fitting

Clean fitting/Chemifit

Bamboo-shoot fitting

Control switch/Detachable series

Jig/Tool/Accessory

Technical information

Reference

Y plug

●Millimeter size type



Product number	Applicable tubing outer diameter (mm)	D1 Insertion part diameter (mm)	L (mm)	L10 (mm)	L11 (mm)	F Tubing insertion length (mm)	P3 (mm)	P4 (mm)	W (mm)	D (mm)	d2 (mm)	Min. inner diameter (mm)	Effective sectional area (mm ²)	Weight (g)
EYA4-4	4	4	48.4	32.4	20.8	13	13.4	11.0	9.8	9.8	3.2	3.0	3.5	8.0
EYA6-6	6	6	52.8	36.3	24.8	15	14.8	12.2	12.5	12.6	4.2	4.5	9.0	14.0
EYA8-8	8	8	56.4	39.4	28.8	16	16.4	14.2	14.6	14.6	4.2	6.0	18.0	19.0
EYA10-10	10	10	63.9	45.4	35.0	19	18.4	17.5	17.5	17.5	4.2	8.0	28.0	31.0
EYA12-12	12	12	70.3	50.3	40.0	20	20.3	20.0	20.0	20.0	4.2	10.0	40.0	42.0

⚠ Caution: Once a Y plug elbow is inserted into a PushOne part, the part cannot be used to connect a tubing.

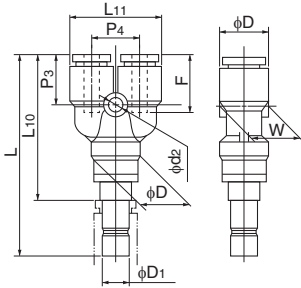

Manifold A type

●Millimeter size type



Product number	Applicable tubing outer diameter (mm)		A Number of ports	L (mm)	L1 (mm)	L2 (mm)	L3 (mm)	L4 (mm)	L5 (mm)	L6 (mm)	L7 (mm)	L8 (mm)	F1 Tubing insertion length (mm)	F2 Tubing insertion length (mm)	P1 (mm)	d1 (mm)	d2 (mm)	Effective sectional area (mm ²)	Weight (g)
	Port A	Port B																	
EMA4-8-6	4	8	6	62.8	31.4	36.0	10.0	19.5	28.8	19.5	9.3	18.5	13	16	10.6	9.8	14.6	—	20.0
EMA4-8-10	4	8	10	84.3	42.2	57.2	10.0	19.8	29.1	19.8	9.3	18.5	13	16	10.6	9.8	14.6	—	33.0
EMA6-10-6	6	10	6	74.7	37.4	44.0	11.5	20.8	30.1	20.8	9.3	18.5	15	19	13.0	12.6	17.5	—	37.0
EMA6-10-10	6	10	10	100.7	50.4	70.0	11.5	21.1	30.4	21.1	9.3	18.5	15	19	13.0	12.6	17.5	—	54.0
EMA8-12-6	8	12	6	84.2	42.1	51.0	12.5	23.0	33.5	23.0	10.5	21.0	16	20	15.5	14.6	20.0	—	50.0
EMA8-12-10	8	12	10	115.1	57.6	82.0	12.5	23.0	33.5	23.0	10.5	21.0	16	20	15.5	14.6	20.0	—	68.0

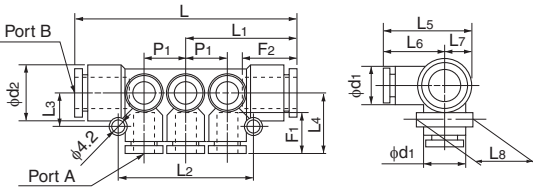

Manifold B type

●Millimeter size type



Product number	Applicable tubing outer diameter (mm)		Thread size (RC)	A Number of ports	L (mm)	L1 (mm)	L2 (mm)	L3 (mm)	L4 (mm)	L5 (mm)	L6 (mm)	L7 (mm)	L8 (mm)	F1 Tubing insertion length (mm)	P1 (mm)	d1 (mm)	H x phi Width across flat (mm)	Effective sectional area (mm ²)	Weight (g)
	Port A	Port B																	
EMB4-1/4-6	4	RC1/4	6	84.0	42.0	36.0	10.0	19.5	28.8	19.5	9.3	18.5	13	10.6	9.8	17.0x18.5	—	58.0	
EMB4-1/4-10	4	RC1/4	10	105.5	52.8	57.2	10.0	19.8	29.1	19.8	9.3	18.5	13	10.6	9.8	17.0x18.5	—	67.0	
EMB6-1/4-6	6	RC1/4	6	96.0	48.0	44.0	11.5	20.8	30.1	20.8	9.3	18.5	15	13.0	12.6	17.0x18.5	—	79.0	
EMB6-1/4-10	6	RC1/4	10	122.0	61.0	70.0	11.5	21.1	30.4	21.1	9.3	18.5	15	13.0	12.6	17.0x18.5	—	96.0	
EMB8-3/8-6	8	RC3/8	6	105.6	52.8	51.0	12.5	23.0	33.5	23.0	10.5	21.0	16	15.5	14.6	19.0x21.0	—	92.0	
EMB8-3/8-10	8	RC3/8	10	136.5	68.3	82.0	12.5	23.0	33.5	23.0	10.5	21.0	16	15.5	14.6	19.0x21.0	—	117.0	

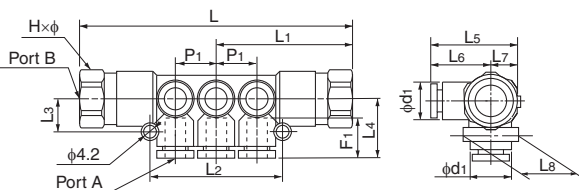

Tubing
Clean tubing
Processed tubing
PushOne fitting
QuickSeal fitting
Clean fitting/Chemifit
Bamboo-shoot fitting
Control switch/Detachable series
Jig/Tool/Accessory
Technical information
Reference

Tubing cap

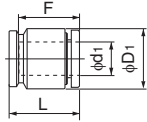

●Millimeter size type

Product number	d ₁ Applicable tubing outer diameter (mm)	D ₁ (mm)	F Tubing insertion length (mm)	L (mm)	Weight (g)
ECC4	4	9.8	13	15.0	2.0
ECC6	6	12.6	15	16.9	3.0
ECC8	8	14.6	16	17.9	4.0
ECC10	10	17.5	19	21.7	6.0
ECC12	12	20.0	20	22.6	8.0

Blank plug

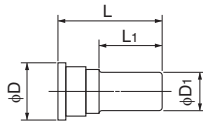

●Millimeter size type

Product number	D ₁ Insertion part diameter (mm)	L (mm)	L ₁ (mm)	D (mm)	Weight (g)
BC3	3	22.0	11.5	5.0	0.5
BC4	4	28.0	15.5	7.7	0.8
BC6	6	28.0	16.0	9.7	1.2
BC8	8	29.0	16.0	11.7	1.7
BC10	10	32.0	17.7	14.0	2.5
BC12	12	34.0	20.4	16.0	3.8

●Inch size type

Product number	D ₁ Insertion part diameter (inch)	L (mm)	L ₁ (mm)	D (mm)	Weight (g)
BC1/4	1/4	28.0	16.0	9.7	1.2
BC3/8	3/8	32.0	17.7	14.0	2.5
BC1/2	1/2	34.0	20.4	16.0	3.8

⚠ Caution: Material: POM (Not flame-retardant resin)

📏 Size 5/16 is shared with BC8.

Nipple

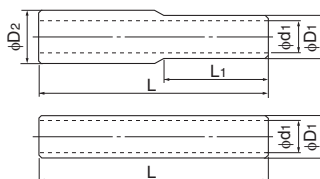

●Millimeter size type

Product number	D ₁ Insertion part diameter (mm)	D ₂ Insertion part diameter (mm)	d ₁ (mm)	L (mm)	L ₁ (mm)	Weight (g)
EN4	4	—	2.5	37.0	—	1.0
EN4-6	4	6	2.5	38.0	18.5	1.0
EN6	6	—	4.0	39.0	—	1.0
EN6-8	6	8	4.0	41.0	19.5	1.0
EN8	8	—	6.0	43.0	—	1.0
EN8-10	8	10	6.0	46.0	21.5	2.0
EN10	10	—	7.5	49.0	—	2.0
EN10-12	10	12	7.5	50.5	24.5	3.0
EN12	12	—	9.0	52.0	—	3.0

⚠ Caution: Material: POM (Not flame-retardant resin)

Tubing

Clean tubing

Processed tubing

PushOne fitting

QuickSeal fitting

Clean fitting/Chemifit

Bamboo-shoot fitting

Control switch/Detachable series

Jig/Tool/Accessory

Technical information

Reference

PushOne™ E Series Brass Body Type

PushOne™ fittings for general air pressure

Features

- PushOne connection of tubing
The tubes can be connected without using a jig or tools.
- Electrically conductive if combined with a UE tubing
- Flame-resistant resin (compliant with V-0 of UL94 standard)
Made of flame-resistant resin PBT. High self-extinguishing performance is compliant with V-0 of UL94 standard. Usable under an environment with spatters.
- Sealing-processed R thread
Sealing tape is not required.
- The tubing direction can be adjusted even after the thread is tightened for types such as elbow, tee, etc.



Cross-sectional structure diagram

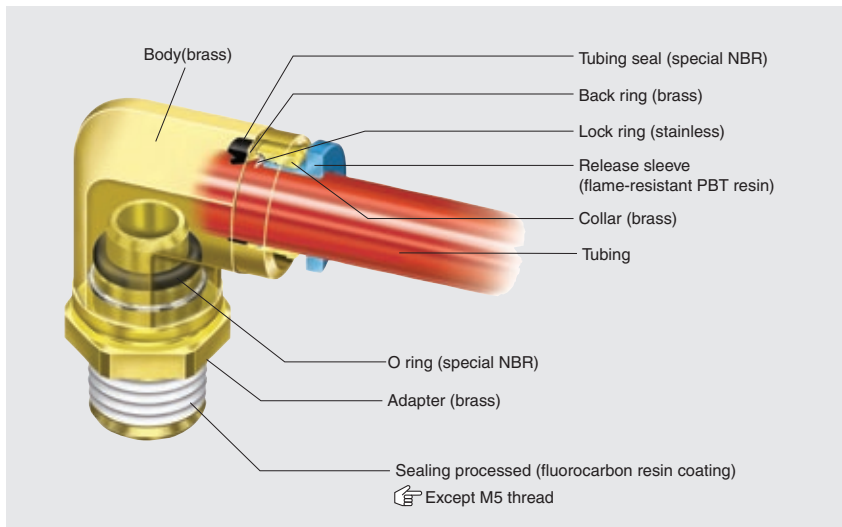

Operating fluid, working temperature range

Operating fluid	Working temperature range
Air	-20°C~+80°C

☞ See "Combination List of Tubing and Fitting" on page 8.

Pressure condition

Maximum working pressure: 1.0MPa
Negative pressure performance: -99.975kPa

Handling instructions

- ⚠ Caution: When the working conditions of tubes and fittings differ, use them under the lower specified conditions.
 - ⚠ Caution: Do not bend the pipe sharply near the tubing insertion port of the fitting. Keep the tubing straight for twice as long as the tubing diameter from the insertion port.
- ☞ See page 34 for the common handling instructions for fittings.

Product number example

MEL 6 - PT1/8

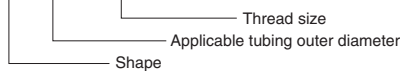

Applicable tubing

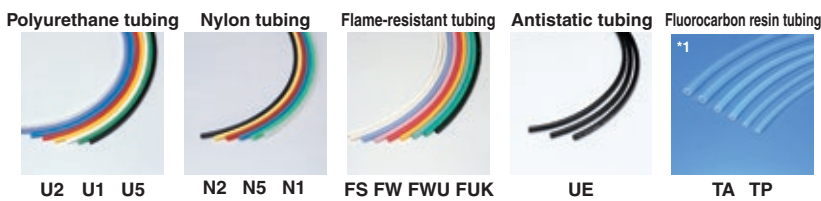

(*1) Combinatory use of TA or TP tubing and PushOne E series of the Brass body type mixes general and clean type performances. When using them together in a clean environment, be aware of how this could lower the cleanliness level.

Related products and product introduction

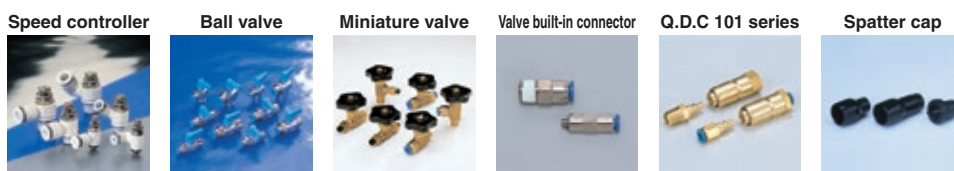

Reference

Instruction manualP.170
UL-94 standard flame testP.195
Effective sectional area ..P.168
Negative-pressure performance listP.169

Tubing
Clean tubing
Processed tubing
PushOne fitting
QuickSeal fitting
Clean fitting/Chemifit
Bamboo-shoot fitting
Control switch/Detachable series
Jig/Tool/Accessory
Technical information
Reference

PushOne™E Series Brass Body Type

Shape list

90 degree elbow
MEL



Tee
MET



Service tee
MEST



Union connector
MEUC



90 degree union elbow
MEUL



Union tee
MEUT



Blank plug
BC



Nipple
EN



☞ Choose a connector from the PushOne A or E series.

Tubing

Clean tubing

Processed tubing

PushOne fitting

QuickSeal fitting

Clean fitting/
Chemifit

Bamboo-shoot fitting

Control switch/
Detachable series

Jig/Tool/
Accessory

Technical information

Reference

PushOne™E Series Brass Body Type

90 degree elbow

●Millimeter size type

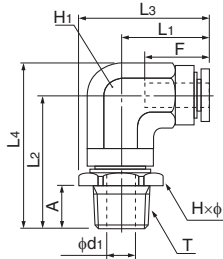

Product number	Applicable tubing outer diameter (mm)	T Thread size (R)	L1 (mm)	L2 (mm)	L3 (mm)	L4 (mm)	A (mm)	F Tubing insertion length (mm)	H×φ Width across flat (mm)	H1 Width across flat (mm)	d1 (mm)	Min. inner diameter (mm)	Effective sectional area (mm ²)	Weight (g)
MEL4-PT1/8	4	R1/8	16.3	26.0	22.8	31.8	8.0	13	12.0×13.0	10.0	5.0	3.0	4.0	22.0
MEL4-PT1/4	4	R1/4	16.3	29.0	24.0	34.8	11.0	13	14.0×15.4	10.0	7.0	3.0	4.0	28.0
MEL6-PT1/8	6	R1/8	18.7	27.0	26.4	33.9	8.0	15	14.0×15.4	12.0	5.0	5.0	12.0	31.0
MEL6-PT1/4	6	R1/4	18.7	30.0	26.4	36.9	11.0	15	14.0×15.4	12.0	7.0	5.0	12.0	35.0
MEL8-PT1/8	8	R1/8	20.2	27.5	29.5	35.6	8.0	16	17.0×18.5	14.0	5.0	5.0	18.5	41.0
MEL8-PT1/4	8	R1/4	20.2	30.5	29.5	38.6	11.0	16	17.0×18.5	14.0	7.0	7.0	23.0	45.0
MEL8-PT3/8	8	R3/8	20.2	31.5	29.5	39.6	12.0	16	17.0×18.5	14.0	9.0	7.0	23.0	53.0
MEL10-PT1/8	10	R1/8	24.6	29.0	35.1	39.4	8.0	19	19.0×21.0	18.0	5.0	5.0	22.0	65.0
MEL10-PT1/4	10	R1/4	24.6	32.0	35.1	42.4	11.0	19	19.0×21.0	18.0	7.0	7.0	34.5	70.0
MEL10-PT3/8	10	R3/8	24.6	33.0	35.1	43.4	12.0	19	19.0×21.0	18.0	9.0	9.0	37.0	75.0
MEL10-PT1/2	10	R1/2	24.6	37.0	36.6	47.4	15.0	19	22.0×24.0	18.0	12.0	9.0	37.0	92.0
MEL12-PT1/4	12	R1/4	26.6	32.0	37.1	42.4	11.0	20	19.0×21.0	18.0	7.0	7.0	36.0	69.0
MEL12-PT3/8	12	R3/8	26.6	33.0	37.1	43.4	12.0	20	19.0×21.0	18.0	9.0	9.0	43.0	75.0
MEL12-PT1/2	12	R1/2	26.6	37.0	38.6	47.4	15.0	20	22.0×24.0	18.0	12.0	9.0	43.0	92.0

Tee

●Millimeter size type

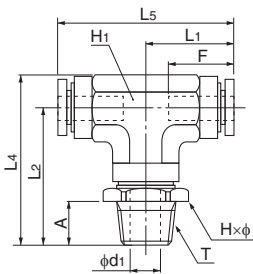

Product number	Applicable tubing outer diameter (mm)	T Thread size (R)	L1 (mm)	L2 (mm)	L4 (mm)	L5 (mm)	A (mm)	F Tubing insertion length (mm)	H×φ Width across flat (mm)	H1 Width across flat (mm)	d1 (mm)	Min. inner diameter (mm)	Effective sectional area (mm ²)	Weight (g)
MET6-PT1/8	6	R1/8	18.7	27.0	33.9	37.3	8.0	15	14.0×15.4	12.0	5.0	5.0	12.0	35.0
MET6-PT1/4	6	R1/4	18.7	30.0	36.9	37.3	11.0	15	14.0×15.4	12.0	7.0	5.0	12.0	39.0
MET8-PT1/8	8	R1/8	20.2	27.5	35.6	40.4	8.0	16	17.0×18.5	14.0	5.0	5.0	18.5	46.0
MET8-PT1/4	8	R1/4	20.2	30.5	38.6	40.4	11.0	16	17.0×18.5	14.0	7.0	7.0	23.0	50.0
MET10-PT1/8	10	R1/8	24.6	29.0	39.4	49.1	8.0	19	19.0×21.0	18.0	5.0	5.0	22.0	80.0
MET10-PT1/4	10	R1/4	24.6	32.0	42.4	49.1	11.0	19	19.0×21.0	18.0	7.0	7.0	34.5	84.0
MET10-PT3/8	10	R3/8	24.6	33.0	43.4	49.1	12.0	19	19.0×21.0	18.0	9.0	9.0	37.0	90.0
MET10-PT1/2	10	R1/2	24.6	37.0	47.4	49.1	15.0	19	22.0×24.0	18.0	12.0	9.0	37.0	106.0
MET12-PT1/4	12	R1/4	26.6	32.0	42.4	53.2	11.0	20	19.0×21.0	18.0	7.0	7.0	36.0	86.0
MET12-PT3/8	12	R3/8	26.6	33.0	43.4	53.2	12.0	20	19.0×21.0	18.0	9.0	9.0	43.0	92.0
MET12-PT1/2	12	R1/2	26.6	37.0	47.4	53.2	15.0	20	22.0×24.0	18.0	12.0	9.0	43.0	108.0

Service tee

●Millimeter size type

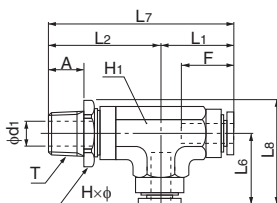

Product number	Applicable tubing outer diameter (mm)	T Thread size (R)	L1 (mm)	L2 (mm)	L6 (mm)	L7 (mm)	L8 (mm)	A (mm)	F Tubing insertion length (mm)	H×φ Width across flat (mm)	H1 Width across flat (mm)	d1 (mm)	Min. inner diameter (mm)	Effective sectional area (mm ²)	Weight (g)
MEST6-PT1/8	6	R1/8	18.7	28.1	18.7	46.8	26.4	8.0	15	14.0×15.4	12.0	5.0	5.0	12.0	37.0
MEST6-PT1/4	6	R1/4	18.7	31.1	18.7	49.8	26.4	11.0	15	14.0×15.4	12.0	7.0	5.0	12.0	41.0
MEST8-PT1/8	8	R1/8	20.2	29.1	20.2	49.3	29.5	8.0	16	17.0×18.5	14.0	5.0	5.0	18.5	50.0
MEST8-PT1/4	8	R1/4	20.2	32.1	20.2	52.3	29.5	11.0	16	17.0×18.5	14.0	7.0	7.0	23.0	54.0
MEST10-PT1/8	10	R1/8	24.6	30.1	24.6	54.7	35.1	8.0	19	19.0×21.0	18.0	5.0	5.0	22.0	82.0
MEST10-PT1/4	10	R1/4	24.6	33.1	24.6	57.7	35.1	11.0	19	19.0×21.0	18.0	7.0	7.0	34.5	86.0
MEST10-PT3/8	10	R3/8	24.6	34.1	24.6	58.7	35.1	12.0	19	19.0×21.0	18.0	9.0	9.0	37.0	92.0
MEST10-PT1/2	10	R1/2	24.6	38.1	24.6	62.7	36.6	15.0	19	22.0×24.0	18.0	12.0	9.0	37.0	108.0
MEST12-PT1/4	12	R1/4	26.6	34.1	26.6	60.7	37.1	11.0	20	19.0×21.0	18.0	7.0	7.0	36.0	90.0
MEST12-PT3/8	12	R3/8	26.6	35.1	26.6	61.7	37.1	12.0	20	19.0×21.0	18.0	9.0	9.0	43.0	95.0
MEST12-PT1/2	12	R1/2	26.6	39.1	26.6	65.7	38.6	15.0	20	22.0×24.0	18.0	12.0	9.0	43.0	112.0

Union connector

● Millimeter size type

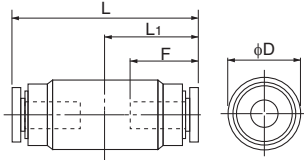

Product number	Applicable tubing outer diameter (mm)	L (mm)	L ₁ (mm)	F Tubing insertion length (mm)	D (mm)	Min. inner diameter (mm)	Effective sectional area (mm ²)	Weight (g)
MEUC6	6	31.5	15.8	15	14.0	5.0	12.5	20.0
MEUC8	8	32.6	16.3	16	16.0	7.0	28.0	27.0
MEUC10	10	39.5	19.8	19	19.0	9.0	45.0	49.0
MEUC12	12	41.4	20.7	20	21.0	11.0	67.0	52.0

90 degree union elbow

● Millimeter size type

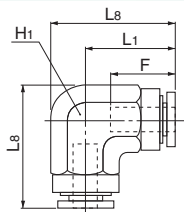

Product number	Applicable tubing outer diameter (mm)	L ₁ (mm)	L ₈ (mm)	F Tubing insertion length (mm)	H ₁ Width across flat (mm)	Min. inner diameter (mm)	Effective sectional area (mm ²)	Weight (g)
MEUL6	6	18.7	25.6	15	12.0	5.0	9.5	20.0
MEUL8	8	20.2	28.3	16	14.0	7.0	19.5	29.0
MEUL10	10	24.6	34.9	19	18.0	9.0	32.5	63.0
MEUL12	12	26.6	37.0	20	18.0	11.0	45.5	56.0

Union tee

● Millimeter size type

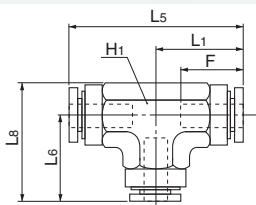

Product number	Applicable tubing outer diameter (mm)	L ₁ (mm)	L ₅ (mm)	L ₆ (mm)	L ₈ (mm)	F Tubing insertion length (mm)	H ₁ Width across flat (mm)	Min. inner diameter (mm)	Effective sectional area (mm ²)	Weight (g)
MEUT6	6	18.7	37.3	18.7	25.6	15	12.0	5.0	9.5	25.0
MEUT8	8	20.2	40.4	20.2	28.3	16	14.0	7.0	19.5	35.0
MEUT10	10	24.6	49.1	24.6	34.9	19	18.0	9.0	32.5	70.0
MEUT12	12	26.6	53.2	26.6	37.0	20	18.0	11.0	45.5	73.0

Blank plug



☞ See the PushOne E series (P.71) for the product number and part sizes.

Nipple



☞ See the PushOne E series (P.71) for the product number and part sizes.

Insertion Type (brass)

Screw-in type for multi-purpose piping

Features

- **Screw-in type**
Consisting of three parts: fitting body, nut and sleeve.
- **High sealing performance**
The insertion part is integrated with a fitting body with high negative-pressure performance.
- **Only the connector is sealed**
Sealing tape is not required.
- **JIS B 8381-1995 (fittings for pneumatic flexible pipes) compliant**



Cross-sectional structure diagram

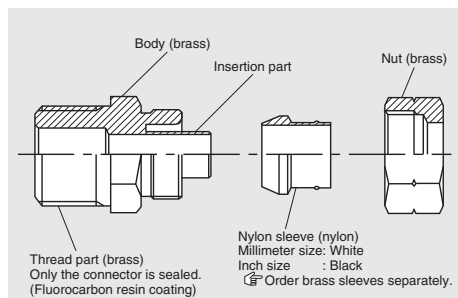

Sealing mechanism

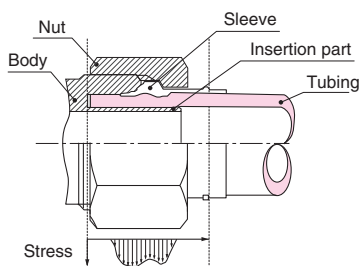

Operating fluid, working temperature range

	Operating fluid	Working temperature range
Air	Nylon sleeve	-40°C~+80°C
	Brass sleeve	-40°C~+100°C
Water	Nylon sleeve	0°C~+70°C
	Brass sleeve	0°C~+100°C
General operating oil	Nylon sleeve	-40°C~+80°C
	Brass sleeve	-40°C~+100°C

☞ Contact us for various chemical liquids.
☞ See "Combination List of Tubing and Fitting" on page 8.

Pressure condition

Maximum working pressure: 5.0MPa
Negative pressure performance: -101.294kPa

Handling instructions

- ⚠ **Caution:** When the working conditions of tubes and fittings differ, use them under the lower specified conditions.
 - ⚠ **Caution:** For use at a high temperature within the working temperature range, tighten nut periodically. If the nut cannot be tightened further, cut the tubing end and insert the tubing again with a new sleeve.
 - ⚠ **Caution:** When water is used as the operating fluid, do not allow it to freeze.
 - ⚠ **Caution:** Do not bend the pipe sharply near the tubing insertion port (sleeve end) of the fitting. Keep the tubing straight for twice as long as the tubing diameter from the insertion port.
 - ⚠ **Caution:** The brass sleeve cannot be used for a fluorocarbon resin TP tubing. Choose the nylon sleeve instead.
 - ⚠ **Caution:** The outer and the inner diameters of the fitting have to be the same as those of the tubing used.
- ☞ See page 34 for the common handling instructions for fittings.

Product number example

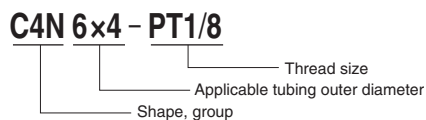

Distinction of millimeter/inch sizes



The inch size type has a black sleeve.
The millimeter size type has a cut at the hexagonal nut.

Applicable tubing



(*1) When QuickSeal series fittings are used on a spatter-resistant line, replace the nylon sleeve with the brass one.
(*2) Combinatory use of PL, PN, TA or TP tubing and QuickSeal series of insertion type (brass) mixes general and clean type performances. When using them together in a clean environment, be aware of how this could lower the cleanliness level.
(*3) The brass sleeve cannot be used for a fluorocarbon resin TP tubing. Choose the nylon sleeve instead.

Related products and product introduction



Reference

Instruction manual.....P.172
Chemical resistance specification table.....P.198
Effective sectional area...P.168
Negative-pressure performance list.....P.169

QuickSeal Series Insertion Type (brass)

Shape list



Inch Size NPT Type (Made to order)



Tubing

Clean tubing

Processed tubing

PushOne fitting

QuickSeal fitting

Clean fitting/Chemifit

Bamboo-shoot fitting

Control switch/Detachable series

Jig/Tool/Accessory

Technical information

Reference

Connector

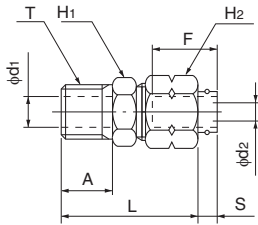

●Millimeter size type (Group 4)

Product number	Applicable tubing outer diameter (mm)	T Thread size (R)	L (mm)	A (mm)	S (mm)	F Tubing insertion length (mm)	H1 Width across flat (mm)	H2 Width across flat (mm)	d1 (mm)	d2 Min. inner diameter (mm)	Effective sectional area (mm ²)	Weight (g)
C4N4x2-PT1/8	4x2	R1/8	28.0	11.0	4.7	15	10.0	10.0	5.0	0.9	0.7	13.0
C4N4x2-PT1/4	4x2	R1/4	30.0	12.0	4.7	15	14.0	10.0	7.0	0.9	0.7	20.0
C4N4x2.5-PT1/8	4x2.5	R1/8	28.0	11.0	4.7	15	10.0	10.0	5.0	1.3	1.5	13.0
C4N4x3-PT1/8	4x3	R1/8	28.0	11.0	4.7	15	10.0	10.0	5.0	2.0	3.0	13.0
C4N6x4-PT1/8	6x4	R1/8	28.0	11.0	4.6	15	10.0	12.0	5.0	2.7	5.0	15.0
C4N6x4-PT1/4	6x4	R1/4	30.0	12.0	4.6	15	14.0	12.0	7.0	2.7	5.0	22.0
C4N6x4-PT3/8	6x4	R3/8	31.0	13.0	4.6	15	17.0	12.0	9.0	2.7	5.5	32.0
C4N6x4.5-PT1/8	6x4.5	R1/8	28.0	11.0	4.6	15	10.0	12.0	5.0	3.2	7.5	15.0
C4N6x4.5-PT1/4	6x4.5	R1/4	30.0	12.0	4.6	15	14.0	12.0	7.0	3.2	7.5	23.0
C4N6x4.5-PT3/8	6x4.5	R3/8	31.0	13.0	4.6	15	17.0	12.0	9.0	3.2	7.5	32.0
C4N8x5-PT1/8	8x5	R1/8	27.9	11.0	4.6	16	12.0	14.0	5.0	3.7	10.0	18.0
C4N8x5-PT1/4	8x5	R1/4	29.9	12.0	4.6	16	14.0	14.0	7.0	3.7	10.0	24.0
C4N8x6-PT1/8	8x6	R1/8	27.9	11.0	4.6	16	12.0	14.0	5.0	4.7	16.0	17.0
C4N8x6-PT1/4	8x6	R1/4	29.9	12.0	4.6	16	14.0	14.0	7.0	4.7	16.0	24.0
C4N8x6-PT3/8	8x6	R3/8	30.9	13.0	4.6	16	17.0	14.0	9.0	4.7	17.0	33.0
C4N10x6.5-PT1/4	10x6.5	R1/4	31.1	12.0	4.2	17	17.0	17.0	7.0	5.2	20.5	32.0
C4N10x6.5-PT3/8	10x6.5	R3/8	32.1	13.0	4.2	17	17.0	17.0	9.0	5.2	20.5	38.0
C4N10x7.5-PT1/4	10x7.5	R1/4	31.1	12.0	4.2	17	17.0	17.0	7.0	6.2	30.0	32.0
C4N10x7.5-PT3/8	10x7.5	R3/8	32.1	13.0	4.2	17	17.0	17.0	9.0	6.2	30.0	37.0
C4N10x7.5-PT1/2	10x7.5	R1/2	40.1	18.0	4.2	17	22.0	17.0	12.0	6.2	30.0	68.5
C4N10x8-PT1/4	10x8	R1/4	31.1	12.0	4.2	17	15.0	17.0	7.0	6.7	32.0	29.0
C4N10x8-PT3/8	10x8	R3/8	32.1	13.0	4.2	17	17.0	17.0	9.0	6.7	32.0	37.0
C4N10x8-PT1/2	10x8	R1/2	40.1	18.0	4.2	17	22.0	17.0	12.0	6.7	33.5	80.0
C4N12x8-PT3/8	12x8	R3/8	35.6	13.0	4.8	18	17.0	19.0	9.0	6.6	32.0	47.0
C4N12x8-PT1/2	12x8	R1/2	40.6	18.0	4.8	18	23.0	19.0	12.0	6.6	33.5	75.0
C4N12x9-PT1/4	12x9	R1/4	31.6	12.0	4.8	18	17.0	19.0	7.6	7.6	40.0	34.0
C4N12x9-PT3/8	12x9	R3/8	35.6	13.0	4.8	18	17.0	19.0	9.0	7.6	40.0	40.5
C4N12x9-PT1/2	12x9	R1/2	40.6	18.0	4.8	18	23.0	19.0	12.0	7.6	40.0	74.0
C4N16x13-PT1/2	16x13	R1/2	46.7	18.0	5.1	23	24.0	27.0	12.0	11.0	90.0	108.0

*Made to order

☞ Only the connector is sealed.

●Inch size type (Group 1)

Product number	Applicable tubing outer diameter (inch)	T Thread size (R)	L (mm)	A (mm)	S (mm)	F Tubing insertion length (mm)	H1 Width across flat (mm)	H2 Width across flat (mm)	d1 (mm)	d2 Min. inner diameter (mm)	Effective sectional area (mm ²)	Weight (g)
C1N1/8-PT1/8	1/8	R1/8	28.0	11.0	4.6	15	10.0	8.0	5.0	1.4	1.5	11.0
C1N3/16-PT1/8	3/16	R1/8	28.1	11.0	4.6	15	10.0	10.0	5.0	2.4	4.0	13.0
C1N3/16-PT1/4	3/16	R1/4	30.1	12.0	4.6	15	14.0	10.0	7.0	2.4	4.0	20.0
C1N1/4-PT1/8	1/4	R1/8	28.0	11.0	4.6	15	10.0	12.0	5.0	3.4	8.5	14.0
C1N1/4-PT1/4	1/4	R1/4	30.0	12.0	4.6	15	14.0	12.0	7.0	3.4	8.5	22.0
C1N1/4-PT3/8	1/4	R3/8	31.0	13.0	4.6	15	17.0	12.0	9.0	3.4	8.5	31.0
C1N5/16-PT1/8	5/16	R1/8	27.8	11.0	4.6	16	12.0	14.0	5.0	4.7	16.0	17.0
C1N5/16-PT1/4	5/16	R1/4	29.8	12.0	4.6	16	14.0	14.0	7.0	4.7	16.0	24.0
C1N5/16-PT3/8	5/16	R3/8	30.8	13.0	4.6	16	17.0	14.0	9.0	4.7	17.0	33.0
C1N3/8-PT1/8	3/8	R1/8	28.7	11.0	4.6	17	14.0	17.0	5.7	5.7	22.5	23.0
C1N3/8-PT1/4	3/8	R1/4	30.7	12.0	4.6	17	14.0	17.0	7.5	5.7	22.5	28.0
C1N3/8-PT3/8	3/8	R3/8	31.7	13.0	4.6	17	17.0	17.0	9.0	5.7	22.5	39.0
C1N3/8-PT1/2	3/8	R1/2	39.7	18.0	4.6	17	23.0	17.0	12.0	5.7	24.5	68.0
C1N1/2-PT1/4	1/2	R1/4	31.8	12.0	4.6	18	17.0	19.0	8.2	8.2	45.0	33.0
C1N1/2-PT3/8	1/2	R3/8	32.8	13.0	4.6	18	17.0	19.0	9.0	8.2	45.0	40.0
C1N1/2-PT1/2	1/2	R1/2	40.8	18.0	4.6	18	23.0	19.0	12.0	8.2	45.0	72.0
C1N5/8-PT3/8	5/8	R3/8	41.7	13.0	5.1	23	23.0	27.0	9.3	9.3	62.0	85.0
C1N5/8-PT1/2	5/8	R1/2	46.7	18.0	5.1	23	23.0	27.0	12.0	9.3	62.0	100.0

●Inch size type (Group 2)

Product number	Applicable tubing outer diameter (inch)	T Thread size (R)	L (mm)	A (mm)	S (mm)	F Tubing insertion length (mm)	H1 Width across flat (mm)	H2 Width across flat (mm)	d1 (mm)	d2 Min. inner diameter (mm)	Effective sectional area (mm ²)	Weight (g)
C2N1/8-PT1/8	1/8	R1/8	28.0	11.0	4.6	21	10.0	8.0	5.0	3.0	1.0	11.0
C2N3/16-PT1/8	3/16	R1/8	28.1	11.0	4.6	15	10.0	10.0	5.0	1.4	1.5	12.0
C2N3/16-PT1/4	3/16	R1/4	30.1	12.0	4.6	15	14.0	10.0	7.0	1.4	1.5	20.0
C2N1/4-PT1/8	1/4	R1/8	28.0	11.0	4.6	15	10.0	12.0	5.0	2.2	3.5	14.5
C2N1/4-PT1/4	1/4	R1/4	30.0	12.0	4.6	15	14.0	12.0	7.0	2.2	3.5	22.0
C2N5/16-PT1/8	5/16	R1/8	27.8	11.0	4.6	16	12.0	14.0	5.0	2.9	6.0	18.0
C2N5/16-PT1/4	5/16	R1/4	29.8	12.0	4.6	16	14.0	14.0	7.0	2.9	6.0	24.0
C2N3/8-PT1/8	3/8	R1/8	28.7	11.0	4.6	17	14.0	17.0	5.0	3.5	8.0	24.0
C2N3/8-PT1/4	3/8	R1/4	30.7	12.0	4.6	17	14.0	17.0	7.0	3.5	8.0	29.0
C2N3/8-PT3/8	3/8	R3/8	31.7	13.0	4.6	17	17.0	17.0	9.0	3.5	8.0	38.0
C2N1/2-PT1/4	1/2	R1/4	31.8	12.0	4.6	18	17.0	19.0	7.0	5.2	20.5	35.0
C2N1/2-PT3/8	1/2	R3/8	32.8	13.0	4.6	18	17.0	19.0	9.0	5.2	20.5	40.0
C2N1/2-PT1/2	1/2	R1/2	40.8	18.0	4.6	18	23.0	19.0	12.0	5.2	20.5	74.0

☆C2N1/8-PT1/8 is of insertless type.

90 degree elbow

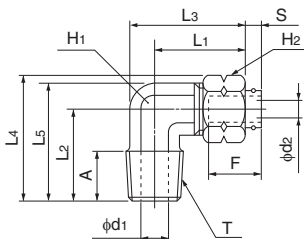

●Millimeter size type (Group 4)

Product number	Applicable tubing outer diameter (mm)	T Thread size (R)	L ₁ (mm)	L ₂ (mm)	L ₃ (mm)	L ₄ (mm)	L ₅ (mm)	A (mm)	S (mm)	F Tubing insertion length (mm)	H ₁ Width across flat (mm)	H ₂ Width across flat (mm)	d ₁ (mm)	d ₂ Min. inner diameter (mm)	Effective sectional area (mm ²)	Weight (g)
L4N4x2-PT1/8	4x2	R1/8	20.5	18.5	26.2	24.3	24.3	11.0	4.7	15	10.0	10.0	5.0	0.9	0.5	19.0
L4N4x2-PT1/4	4x2	R1/4	20.5	22.0	27.4	27.8	28.9	12.0	4.7	15	12.0	10.0	7.0	0.9	0.5	28.0
L4N4x2.5-PT1/8	4x2.5	R1/8	20.5	18.5	26.2	24.3	24.3	11.0	4.7	15	10.0	10.0	5.0	1.3	1.5	19.0
L4N4x3-PT1/8	4x3	R1/8	20.5	18.5	26.2	24.3	24.3	11.0	4.7	15	10.0	10.0	5.0	2.0	2.5	19.0
L4N6x4-PT1/8	6x4	R1/8	20.5	18.5	26.3	25.4	24.3	11.0	4.6	15	10.0	12.0	5.0	2.7	4.5	21.0
L4N6x4-PT1/4	6x4	R1/4	23.0	22.0	29.9	28.9	28.9	12.0	4.6	15	12.0	12.0	7.0	2.7	4.5	32.0
L4N6x4.5-PT1/8	6x4.5	R1/8	20.5	18.5	26.3	25.4	24.3	11.0	4.6	15	10.0	12.0	5.0	3.2	7.0	21.0
L4N6x4.5-PT1/4	6x4.5	R1/4	23.0	22.0	29.9	28.9	28.9	12.0	4.6	15	12.0	12.0	7.0	3.2	7.0	32.0
L4N8x5-PT1/8	8x5	R1/8	22.9	21.0	29.8	29.1	27.9	11.0	4.6	16	12.0	14.0	5.0	3.7	9.0	31.0
L4N8x5-PT1/4	8x5	R1/4	22.9	22.0	29.8	30.1	28.9	12.0	4.6	16	12.0	14.0	7.0	3.7	9.0	32.5
L4N8x6-PT1/8	8x6	R1/8	22.9	21.0	29.8	29.1	27.9	11.0	4.6	16	12.0	14.0	5.0	4.7	14.0	31.0
L4N8x6-PT1/4	8x6	R1/4	22.9	22.0	29.8	30.1	28.9	12.0	4.6	16	12.0	14.0	7.0	4.7	15.0	32.5
L4N8x6-PT3/8	8x6	R3/8	22.9	26.0	31.0	34.1	34.1	13.0	4.6	16	14.0	14.0	9.0	4.7	15.0	45.0
L4N10x6.5-PT1/4	10x6.5	R1/4	27.1	25.0	35.2	34.8	33.1	13.5	4.2	17	14.0	17.0	7.0	5.2	18.0	47.0
L4N10x6.5-PT3/8	10x6.5	R3/8	27.1	26.0	35.2	35.8	34.1	13.0	4.2	17	14.0	17.0	9.0	5.2	18.0	50.0
L4N10x7.5-PT1/4	10x7.5	R1/4	27.1	25.0	35.2	34.8	33.1	13.5	4.2	17	14.0	17.0	7.0	6.2	24.0	48.0
L4N10x7.5-PT3/8	10x7.5	R3/8	27.1	26.0	35.2	35.8	34.1	13.0	4.2	17	14.0	17.0	9.0	6.2	26.0	51.0
L4N10x7.5-PT1/2	10x7.5	R1/2	27.1	33.0	35.2	42.8	41.1	18.0	4.2	17	14.0	17.0	10.0	6.2	26.0	83.0
L4N10x8-PT1/4	10x8	R1/4	27.1	25.0	35.2	34.8	33.1	13.5	4.2	17	14.0	17.0	7.0	6.7	25.0	48.0
L4N10x8-PT3/8	10x8	R3/8	27.1	26.0	35.2	35.8	34.1	13.0	4.2	17	14.0	17.0	9.0	6.7	25.0	51.0
L4N10x8-PT1/2	10x8	R1/2	27.1	33.0	35.2	42.8	41.1	18.0	4.2	17	14.0	17.0	10.0	6.7	30.0	83.0
L4N12x8-PT3/8	12x8	R3/8	27.6	26.0	35.7	37.0	34.1	13.0	4.8	18	14.0	19.0	9.0	6.6	25.0	53.0
L4N12x8-PT1/2	12x8	R1/2	30.1	33.0	38.2	44.0	41.1	18.0	4.8	18	14.0	19.0	10.0	6.6	30.0	90.0
L4N12x9-PT1/4	12x9	R1/4	27.6	25.0	35.7	36.0	33.1	13.5	4.8	18	14.0	19.0	7.0	7.6	33.0	50.0
L4N12x9-PT3/8	12x9	R3/8	27.6	26.0	35.7	37.0	34.1	13.0	4.8	18	14.0	19.0	9.0	7.6	33.0	54.0
L4N12x9-PT1/2	12x9	R1/2	30.6	33.0	38.7	44.0	41.1	18.0	4.8	18	14.0	19.0	10.0	7.6	33.0	91.0
L4N16x13-PT1/2	16x13	R1/2	36.7	33.0	47.1	48.6	43.4	18.0	5.1	23	18.0	27.0	12.0	11.0	72.0	120.0

●Inch size type (Group 1)

Product number	Applicable tubing outer diameter (mm)	T Thread size (R)	L ₁ (mm)	L ₂ (mm)	L ₃ (mm)	L ₄ (mm)	L ₅ (mm)	A (mm)	S (mm)	F Tubing insertion length (mm)	H ₁ Width across flat (mm)	H ₂ Width across flat (mm)	d ₁ (mm)	d ₂ Min. inner diameter (mm)	Effective sectional area (mm ²)	Weight (g)
L1N1/8-PT1/8	1/8	R1/8	20.5	18.5	26.3	23.1	24.3	11.0	4.6	15	10.0	8.0	5.0	1.4	1.5	15.0
L1N3/16-PT1/8	3/16	R1/8	20.6	18.5	26.3	24.3	24.3	11.0	4.6	15	10.0	10.0	5.0	2.4	4.0	18.0
L1N3/16-PT1/4	3/16	R1/4	23.1	22.0	30.0	27.8	28.9	12.0	4.6	15	12.0	10.0	7.0	2.4	4.0	28.0
L1N1/4-PT1/8	1/4	R1/8	20.5	18.5	26.3	25.4	24.3	11.0	4.6	15	10.0	12.0	5.0	3.4	8.0	20.0
L1N1/4-PT1/4	1/4	R1/4	23.0	22.0	29.8	28.9	27.8	12.0	4.6	15	10.0	12.0	7.0	3.4	8.0	26.0
L1N1/4-PT3/8	1/4	R3/8	26.0	26.0	34.6	32.9	34.1	13.0	4.6	15	14.0	12.0	9.0	3.4	8.0	44.0
L1N5/16-PT1/8	5/16	R1/8	22.8	21.0	29.8	29.1	27.9	11.0	4.6	16	12.0	14.0	5.0	4.7	15.0	30.0
L1N5/16-PT1/4	5/16	R1/4	22.8	22.0	29.8	30.1	28.9	12.0	4.6	16	12.0	14.0	7.0	4.7	15.0	32.0
L1N5/16-PT3/8	5/16	R3/8	25.8	26.0	34.4	34.1	34.1	13.0	4.6	16	14.0	14.0	9.0	4.7	15.0	48.0
L1N3/8-PT1/8	3/8	R1/8	23.7	21.0	30.6	30.8	27.9	11.0	4.6	17	12.0	17.0	5.0	5.7	15.0	35.0
L1N3/8-PT1/4	3/8	R1/4	23.7	22.0	30.6	31.8	28.9	12.0	4.6	17	12.0	17.0	7.0	5.7	19.0	50.0
L1N3/8-PT3/8	3/8	R3/8	26.7	26.0	35.2	35.8	32.9	13.0	4.6	17	12.0	17.0	7.0	5.7	19.0	50.0
L1N3/8-PT1/2	3/8	R1/2	26.7	33.0	37.5	42.8	41.1	18.0	4.6	17	14.0	17.0	10.0	5.7	22.5	84.0
L1N1/2-PT1/4	1/2	R1/4	27.8	25.0	35.9	36.0	33.1	13.5	4.6	18	14.0	19.0	7.0	8.2	32.0	50.0
L1N1/2-PT3/8	1/2	R3/8	27.8	26.0	36.3	37.0	34.1	13.0	4.6	18	14.0	19.0	9.0	8.2	32.0	53.0
L1N1/2-PT1/2	1/2	R1/2	30.8	33.0	41.6	44.0	41.1	18.0	4.6	18	14.0	19.0	10.0	8.2	32.0	76.0
L1N5/8-PT3/8	5/8	R3/8	36.7	28.0	47.1	43.6	38.4	15.0	5.1	23	18.0	27.0	9.0	9.3	48.0	107.0
L1N5/8-PT1/2	5/8	R1/2	36.7	33.0	47.5	48.6	43.4	18.0	5.1	23	18.0	27.0	12.0	9.3	53.0	117.0

●Inch size type (Group 2)

Product number	Applicable tubing outer diameter (mm)	T Thread size (R)	L ₁ (mm)	L ₂ (mm)	L ₃ (mm)	L ₄ (mm)	L ₅ (mm)	A (mm)	S (mm)	F Tubing insertion length (mm)	H ₁ Width across flat (mm)	H ₂ Width across flat (mm)	d ₁ (mm)	d ₂ Min. inner diameter (mm)	Effective sectional area (mm ²)	Weight (g)
L2N1/8-PT1/8	1/8	R1/8	20.5	18.5	26.3	23.1	24.3	11.0	4.6	21	10.0	8.0	5.0	3.0	1.5	16.0
L2N3/16-PT1/8	3/16	R1/8	20.6	18.5	26.3	24.3	24.3	11.0	4.6	15	10.0	10.0	5.0	1.4	1.5	19.0
L2N1/4-PT1/8	1/4	R1/8	20.5	18.5	26.3	25.4	24.3	11.0	4.6	15	10.0	12.0	5.0	2.2	3.5	21.0
L2N1/4-PT1/4	1/4	R1/4	23.0	22.0	28.8	28.9	27.8	12.0	4.6	15	10.0	12.0	7.0	2.2	3.5	31.0
L2N5/16-PT1/8	5/16	R1/8	22.8	21.0	29.8	29.1	27.9	11.0	4.6	16	12.0	14.0	5.0	2.9	5.0	31.0
L2N5/16-PT1/4	5/16	R1/4	22.8	22.0	29.8	30.1	28.9	12.0	4.6	16	12.0	14.0	7.0	2.9	5.0	33.0
L2N3/8-PT1/4	3/8	R1/4	23.7	22.0	30.6	31.8	28.9	12.0	4.6	17	12.0	17.0	7.0	3.5	7.5	37.0
L2N3/8-PT3/8	3/8	R3/8	26.7	26.0	35.2	35.8	32.9	13.0	4.6	17	12.0	17.0	7.0	3.5	7.5	55.0
L2N1/2-PT1/4	1/2	R1/4	27.8	25.0	35.9	36.0	33.1	13.5	4.6	18	14.0	19.0	7.0	5.2	18.0	54.0
L2N1/2-PT3/8	1/2	R3/8	27.8	26.0	36.3	37.0	34.1	13.0	4.6	18	14.0	19.0	9.0	5.2	18.0	57.0
L2N1/2-PT1/2	1/2	R1/2	30.3	33.0	41.1	44.0	43.4	18.0	4.6	18	18.0	19.0	12.0	5.2	18.0	89.0

☆L2N1/8-PT1/8 is of insertless type.

Tubing

Clean tubing

Processed tubing

PushOne fitting

QuickSeal fitting

Clean fitting/Chemfit

Bamboo-shoot fitting

Control switch/Detachable series

Jig/Tool/Accessory

Technical information

Reference

QuickSeal Series Insertion Type (brass)

Tee

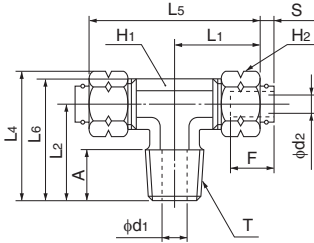

●Millimeter size type (Group 4)

Product number	Applicable tubing outer diameter/inner diameter (mm)	T Thread size (R)	L ₁ (mm)	L ₂ (mm)	L ₄ (mm)	L ₅ (mm)	L ₆ (mm)	A (mm)	S (mm)	F Tubing insertion length (mm)	H ₁ Width across flat (mm)	H ₂ Width across flat (mm)	d ₁ (mm)	d ₂ Min. inner diameter (mm)	Effective sectional area (mm ²)	Weight (g)
T4N4x2-PT1/8	4x2	R1/8	20.5	18.5	24.3	40.9	24.3	11.0	4.7	15	10.0	10.0	5.0	0.9	0.5	25.0
T4N4x2.5-PT1/8	4x2.5	R1/8	20.5	18.5	24.3	40.9	24.3	11.0	4.7	15	10.0	10.0	5.0	1.3	1.5	25.0
T4N4x3-PT1/8	4x3	R1/8	20.5	18.5	24.3	40.9	24.3	11.0	4.7	15	10.0	10.0	5.0	2.0	2.5	25.0
T4N6x4-PT1/8	6x4	R1/8	20.5	18.5	25.4	41.0	24.3	11.0	4.6	15	10.0	12.0	5.0	2.7	4.5	30.0
T4N6x4-PT1/4	6x4	R1/4	23.0	22.0	28.9	46.0	28.9	12.0	4.6	15	12.0	12.0	7.0	2.7	4.5	43.0
T4N6x4.5-PT1/8	6x4.5	R1/8	20.5	18.5	25.4	41.0	24.3	11.0	4.6	15	10.0	12.0	5.0	3.2	7.0	31.0
T4N6x4.5-PT1/4	6x4.5	R1/4	23.0	22.0	28.9	46.0	28.9	12.0	4.6	15	12.0	12.0	7.0	3.2	7.0	43.0
T4N8x5-PT1/8	8x5	R1/8	22.9	21.0	29.1	45.8	27.9	11.0	4.6	16	12.0	14.0	5.0	3.7	9.0	43.0
T4N8x5-PT1/4	8x5	R1/4	22.9	22.0	30.1	45.8	28.9	12.0	4.6	16	12.0	14.0	7.0	3.7	9.0	45.0
T4N8x6-PT1/8	8x6	R1/8	22.9	21.0	29.1	45.8	27.9	11.0	4.6	16	12.0	14.0	5.0	4.7	14.0	42.0
T4N8x6-PT1/4	8x6	R1/4	22.9	22.0	30.1	45.8	28.9	12.0	4.6	16	12.0	14.0	7.0	4.7	15.0	44.0
T4N8x6-PT3/8	8x6	R3/8	22.9	26.0	34.1	45.8	34.1	13.0	4.6	16	14.0	14.0	9.0	4.7	15.0	58.0
T4N10x6.5-PT1/4	10x6.5	R1/4	27.1	25.0	34.8	54.2	33.1	12.0	4.2	17	14.0	17.0	7.0	5.2	18.0	73.0
T4N10x6.5-PT3/8	10x6.5	R3/8	28.1	26.0	35.8	56.2	34.1	13.0	4.2	17	14.0	17.0	9.0	5.2	18.0	78.0
T4N10x7.5-PT1/4	10x7.5	R1/4	27.1	25.0	34.8	54.2	33.1	12.0	4.2	17	14.0	17.0	7.0	6.2	24.0	70.0
T4N10x7.5-PT3/8	10x7.5	R3/8	27.1	26.0	35.8	54.2	34.1	13.0	4.2	17	14.0	17.0	9.0	6.2	26.0	76.0
T4N10x7.5-PT1/2	10x7.5	R1/2	27.1	33.0	42.8	54.2	43.4	18.0	4.2	17	18.0	17.0	12.0	6.2	26.0	110.0
T4N10x8-PT1/4	10x8	R1/4	27.1	25.0	34.8	54.2	33.1	12.0	4.2	17	14.0	17.0	7.0	6.7	25.0	69.0
T4N10x8-PT3/8	10x8	R3/8	27.1	26.0	35.8	54.2	34.1	13.0	4.2	17	14.0	17.0	9.0	6.7	25.0	75.0
T4N10x8-PT1/2	10x8	R1/2	27.1	33.0	42.8	54.2	43.4	18.0	4.2	17	18.0	17.0	12.0	6.7	30.0	109.0
T4N12x8-PT3/8	12x8	R3/8	27.6	25.0	36.0	55.3	33.1	13.0	4.8	18	14.0	19.0	9.0	6.6	25.0	82.0
T4N12x8-PT1/2	12x8	R1/2	30.6	33.0	44.0	61.3	43.4	18.0	4.8	18	18.0	19.0	12.0	6.6	30.0	128.0
T4N12x9-PT1/4	12x9	R1/4	27.6	25.0	36.0	55.3	33.1	12.0	4.8	18	14.0	19.0	7.0	7.6	33.0	75.0
T4N12x9-PT3/8	12x9	R3/8	27.6	26.0	37.0	55.3	34.1	13.0	4.8	18	14.0	19.0	9.0	7.6	33.0	82.0
T4N12x9-PT1/2	12x9	R1/2	30.6	33.0	44.0	61.3	43.4	18.0	4.8	18	18.0	19.0	12.0	7.6	33.0	128.0
T4N16x13-PT1/2	16x13	R1/2	36.7	33.0	48.6	73.4	43.4	18.0	5.1	23	18.0	27.0	12.0	11.0	72.0	165.0

*Made to order

●Inch size type (Group 1)

Product number	Applicable tubing outer diameter/inner diameter (mm)	T Thread size (R)	L ₁ (mm)	L ₂ (mm)	L ₄ (mm)	L ₅ (mm)	L ₆ (mm)	A (mm)	S (mm)	F Tubing insertion length (mm)	H ₁ Width across flat (mm)	H ₂ Width across flat (mm)	d ₁ (mm)	d ₂ Min. inner diameter (mm)	Effective sectional area (mm ²)	Weight (g)
T1N1/8-PT1/8	1/8	R1/8	20.5	18.5	23.1	41.1	24.3	11.0	4.6	15	10.0	8.0	5.0	1.4	1.5	21.0
T1N3/16-PT1/8	3/16	R1/8	20.6	18.5	24.3	41.1	24.3	11.0	4.6	15	10.0	10.0	5.0	2.4	4.0	26.0
T1N1/4-PT1/8	1/4	R1/8	20.5	18.5	25.4	41.1	24.3	11.0	4.6	15	10.0	12.0	5.0	3.4	8.0	29.0
T1N1/4-PT1/4	1/4	R1/4	23.0	22.0	28.9	46.1	28.9	12.0	4.6	15	12.0	12.0	7.0	3.4	8.0	42.0
T1N5/16-PT1/8	5/16	R1/8	22.8	21.0	29.1	45.7	27.9	11.0	4.6	16	12.0	14.0	5.0	4.7	15.0	42.0
T1N5/16-PT1/4	5/16	R1/4	22.8	22.0	30.1	45.7	28.9	12.0	4.6	16	12.0	14.0	7.0	4.7	15.0	45.0
T1N5/16-PT3/8	5/16	R3/8	25.8	26.0	34.1	51.7	34.1	13.0	4.6	16	14.0	14.0	9.0	4.7	15.0	66.0
T1N3/8-PT1/4	3/8	R1/4	23.7	22.0	31.8	47.4	28.9	12.0	4.6	17	12.0	17.0	7.0	5.7	19.0	55.0
T1N3/8-PT3/8	3/8	R3/8	26.7	26.0	35.8	53.4	34.1	13.0	4.6	17	14.0	17.0	9.0	5.7	19.0	77.0
T1N3/8-PT1/2	3/8	R1/2	29.7	33.0	42.8	59.4	43.4	18.0	4.6	17	18.0	17.0	12.0	5.7	22.5	122.0
T1N1/2-PT3/8	1/2	R3/8	27.8	26.0	37.0	55.6	34.1	13.0	4.6	18	14.0	19.0	9.0	8.2	32.0	79.0
T1N1/2-PT1/2	1/2	R1/2	30.8	33.0	44.0	61.6	43.4	18.0	4.6	18	18.0	19.0	12.0	8.2	32.0	119.0
T1N5/8-PT3/8	5/8	R3/8	36.7	28.0	43.6	73.3	38.4	13.0	5.1	23	18.0	27.0	9.0	9.3	48.0	130.0
T1N5/8-PT1/2	5/8	R1/2	36.7	33.0	48.6	73.3	43.4	18.0	5.1	23	18.0	27.0	12.0	9.3	53.0	172.0

●Inch size type (Group 2)

Product number	Applicable tubing outer diameter/inner diameter (mm)	T Thread size (R)	L ₁ (mm)	L ₂ (mm)	L ₄ (mm)	L ₅ (mm)	L ₆ (mm)	A (mm)	S (mm)	F Tubing insertion length (mm)	H ₁ Width across flat (mm)	H ₂ Width across flat (mm)	d ₁ (mm)	d ₂ Min. inner diameter (mm)	Effective sectional area (mm ²)	Weight (g)
T2N1/8-PT1/8	1/8	R1/8	20.5	18.5	23.1	41.1	24.3	11.0	4.6	21	10.0	8.0	5.0	3.0	1.5	20.5
T2N3/16-PT1/8	3/16	R1/8	20.6	18.5	24.3	41.1	24.3	11.0	4.6	15	10.0	10.0	5.0	1.4	1.5	25.0
T2N1/4-PT1/8	1/4	R1/8	20.5	18.5	25.4	41.1	24.3	11.0	4.6	15	10.0	12.0	5.0	2.2	3.5	30.0
T2N1/4-PT1/4	1/4	R1/4	23.0	22.0	28.9	46.1	28.9	12.0	4.6	15	12.0	12.0	7.0	2.2	3.5	43.0
T2N5/16-PT1/8	5/16	R1/8	22.8	21.0	29.1	45.7	27.9	11.0	4.6	16	12.0	14.0	5.0	2.9	5.0	45.0
T2N5/16-PT1/4	5/16	R1/4	22.8	22.0	30.1	45.7	28.9	12.0	4.6	16	12.0	14.0	7.0	2.9	5.0	43.0
T2N3/8-PT1/4	3/8	R1/4	23.7	22.0	31.8	47.4	28.9	12.0	4.6	17	12.0	17.0	7.0	3.5	7.5	57.0
T2N3/8-PT3/8	3/8	R3/8	26.7	26.0	35.8	53.4	34.1	13.0	4.6	17	14.0	17.0	9.0	3.5	7.5	78.0
T2N1/2-PT3/8	1/2	R3/8	27.8	26.0	37.0	55.6	34.1	13.0	4.6	18	14.0	19.0	9.0	5.2	18.0	80.0

☆C2N1/8-PT1/8 is of insertless type.

Tubing
Clean tubing
Processed tubing
PushOne fitting
QuickSeal fitting
Clean fitting/Chemifit
Bamboo-shoot fitting
Control switch/Detachable series
Jig/Tool/Accessory
Technical information
Reference

Service tee

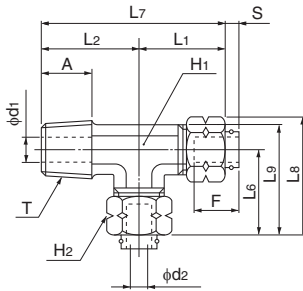

●Millimeter size type (Group 4)

Product number	Applicable tubing outer diameter (mm)	T Thread size (R)	L1 (mm)	L2 (mm)	L3 (mm)	L4 (mm)	L5 (mm)	L6 (mm)	L7 (mm)	L8 (mm)	L9 (mm)	A (mm)	S (mm)	F Tubing insertion length (mm)	H1 Width across flat (mm)	H2 Width across flat (mm)	d1 (mm)	d2 Min. inner diameter (mm)	Effective sectional area (mm ²)	Weight (g)
ST4N4x2-PT1/8	4x2	R1/8	20.5	18.5	20.5	39.0	26.2	26.2	11.0	4.7	15	10.0	10.0	5.0	0.9	0.5	26.0			
ST4N4x2.5-PT1/8	4x2.5	R1/8	20.5	18.5	20.5	39.0	26.2	26.2	11.0	4.7	15	10.0	10.0	5.0	1.3	1.5	26.0			
ST4N4x3-PT1/8	4x3	R1/8	20.5	18.5	20.5	39.0	26.2	26.2	11.0	4.7	15	10.0	10.0	5.0	2.0	2.5	26.0			
ST4N6x4-PT1/8	6x4	R1/8	20.5	18.5	20.5	39.0	27.4	26.3	11.0	4.6	15	10.0	12.0	5.0	2.7	4.5	41.0			
ST4N6x4-PT1/4	6x4	R1/4	23.0	22.0	23.0	45.0	29.9	29.9	12.0	4.6	15	12.0	12.0	7.0	2.7	4.5	30.0			
ST4N6x4.5-PT1/8	6x4.5	R1/8	20.5	18.5	20.5	39.0	27.4	26.3	11.0	4.6	15	10.0	12.0	5.0	3.2	7.0	41.0			
ST4N6x4.5-PT1/4	6x4.5	R1/4	23.0	22.0	23.0	45.0	29.9	29.9	12.0	4.6	15	12.0	12.0	7.0	3.2	7.0	43.0			
ST4N8x5-PT1/8	8x5	R1/8	22.9	21.0	22.9	43.9	31.0	29.8	11.0	4.6	16	12.0	14.0	5.0	3.7	9.0	43.0			
ST4N8x5-PT1/4	8x5	R1/4	22.9	22.0	22.9	44.9	31.0	29.8	12.0	4.6	16	12.0	14.0	7.0	3.7	9.0	43.0			
ST4N8x6-PT1/8	8x6	R1/8	22.9	21.0	22.9	43.9	31.0	29.8	11.0	4.6	16	12.0	14.0	5.0	4.7	14.0	45.0			
ST4N8x6-PT1/4	8x6	R1/4	22.9	22.0	22.9	44.9	31.0	29.8	12.0	4.6	16	12.0	14.0	7.0	4.7	15.0	46.0			
ST4N8x6-PT3/8	8x6	R3/8	22.9	26.0	22.9	48.9	31.0	31.0	13.0	4.6	16	14.0	14.0	9.0	4.7	15.0	60.0			
ST4N10x6.5-PT1/4	10x6.5	R1/4	27.1	25.0	27.1	52.1	36.9	35.2	12.0	4.2	17	14.0	17.0	7.0	5.2	18.0	72.0			
ST4N10x6.5-PT3/8	10x6.5	R3/8	27.1	26.0	27.1	53.1	36.9	35.2	13.0	4.2	17	14.0	17.0	9.0	5.2	18.0	70.0			
ST4N10x7.5-PT1/4	10x7.5	R1/4	27.1	25.0	27.1	52.1	36.9	35.2	12.0	4.2	17	14.0	17.0	7.0	6.2	24.0	70.0			
ST4N10x7.5-PT3/8	10x7.5	R3/8	27.1	26.0	27.1	53.1	36.9	35.2	13.0	4.2	17	14.0	17.0	9.0	6.2	26.0	76.0			
ST4N10x7.5-PT1/2	10x7.5	R1/2	27.1	35.5	27.1	62.6	36.9	37.5	18.0	4.2	17	18.0	17.0	12.0	6.2	26.0	74.0			
ST4N10x8-PT1/4	10x8	R1/4	27.1	25.0	27.1	52.1	36.9	35.2	12.0	4.2	17	14.0	17.0	7.0	6.7	25.0	76.0			
ST4N10x8-PT3/8	10x8	R3/8	27.1	26.0	27.1	53.1	36.9	35.2	13.0	4.2	17	14.0	17.0	9.0	6.7	25.0	113.0			
ST4N10x8-PT1/2	10x8	R1/2	27.1	35.5	27.1	62.6	36.9	37.5	18.0	4.2	17	18.0	17.0	12.0	6.7	30.0	125.0			
ST4N12x8-PT3/8	12x8	R3/8	27.6	26.0	27.6	53.6	38.6	35.7	13.0	4.8	18	14.0	19.0	9.0	6.6	25.0	81.0			
ST4N12x8-PT1/2	12x8	R1/2	30.1	35.5	30.1	65.6	41.1	40.5	18.0	4.8	18	18.0	19.0	12.0	6.6	30.0	82.0			
ST4N12x9-PT3/8	12x9	R3/8	27.6	26.0	27.6	53.6	38.6	35.7	13.0	4.8	18	14.0	19.0	9.0	7.6	33.0	130.0			
ST4N12x9-PT1/2	12x9	R1/2	30.1	35.5	30.1	65.6	41.1	40.5	18.0	4.8	18	18.0	19.0	12.0	7.6	33.0	128.0			

*Made to order

●Inch size type (Group 1)

Product number	Applicable tubing outer diameter (mm)	T Thread size (R)	L1 (mm)	L2 (mm)	L3 (mm)	L4 (mm)	L5 (mm)	L6 (mm)	L7 (mm)	L8 (mm)	L9 (mm)	A (mm)	S (mm)	F Tubing insertion length (mm)	H1 Width across flat (mm)	H2 Width across flat (mm)	d1 (mm)	d2 Min. inner diameter (mm)	Effective sectional area (mm ²)	Weight (g)
ST1N1/8-PT1/8	1/8	R1/8	20.5	18.5	20.5	39.0	25.2	26.3	11.0	4.6	15	10.0	8.0	5.0	1.4	1.5	22.0			
ST1N3/16-PT1/8	3/16	R1/8	20.6	18.5	20.6	39.1	26.3	26.3	11.0	4.6	15	10.0	10.0	5.0	2.4	4.0	25.0			
ST1N3/16-PT1/4	3/16	R1/4	23.1	22.0	23.1	45.1	28.8	30.0	12.0	4.6	15	12.0	10.0	7.0	2.4	4.0	37.0			
ST1N1/4-PT1/8	1/4	R1/8	20.5	18.5	20.5	39.0	27.5	26.3	11.0	4.6	15	10.0	12.0	5.0	3.4	8.0	29.0			
ST1N1/4-PT1/4	1/4	R1/4	23.0	22.0	23.0	45.0	30.0	30.0	12.0	4.6	15	12.0	12.0	7.0	3.4	8.0	41.0			
ST1N5/16-PT1/8	5/16	R1/8	22.8	21.0	22.8	43.8	30.9	29.8	11.0	4.6	16	12.0	14.0	5.0	4.7	15.0	44.0			
ST1N5/16-PT1/4	5/16	R1/4	22.8	22.0	22.8	44.8	30.9	29.8	12.0	4.6	16	12.0	14.0	7.0	4.7	15.0	45.0			
ST1N3/8-PT1/4	3/8	R1/4	23.7	22.0	23.7	45.7	33.5	30.6	12.0	4.6	17	12.0	17.0	7.0	5.7	19.0	56.0			
ST1N3/8-PT3/8	3/8	R3/8	26.7	26.0	26.7	52.7	36.5	34.8	13.0	4.6	17	14.0	17.0	9.0	5.7	19.0	77.0			
ST1N3/8-PT1/2	3/8	R1/2	29.2	35.5	29.2	64.7	39.0	39.6	18.0	4.6	17	18.0	17.0	12.0	5.7	22.5	124.0			
ST1N1/2-PT3/8	1/2	R3/8	27.8	26.0	27.8	53.8	38.8	35.9	13.0	4.6	18	14.0	19.0	9.0	8.2	32.0	81.0			
ST1N1/2-PT1/2	1/2	R1/2	30.3	35.5	30.3	65.8	41.3	40.7	18.0	4.6	18	18.0	19.0	12.0	8.2	32.0	122.0			
ST1N5/8-PT1/2	5/8	R1/2	36.7	35.5	34.2	72.2	49.8	44.6	18.0	5.1	23	18.0	27.0	12.0	9.3	53.0	179.0			

*Made to order

●Inch size type (Group 2)

Product number	Applicable tubing outer diameter (mm)	T Thread size (R)	L1 (mm)	L2 (mm)	L3 (mm)	L4 (mm)	L5 (mm)	L6 (mm)	L7 (mm)	L8 (mm)	L9 (mm)	A (mm)	S (mm)	F Tubing insertion length (mm)	H1 Width across flat (mm)	H2 Width across flat (mm)	d1 (mm)	d2 Min. inner diameter (mm)	Effective sectional area (mm ²)	Weight (g)
ST2N1/8-PT1/8	1/8	R1/8	20.5	18.5	20.5	39.0	25.2	26.3	11.0	4.6	21	10.0	8.0	5.0	3.0	1.5	21.0			
ST2N3/16-PT1/8	3/16	R1/8	20.6	18.5	20.6	39.1	26.3	26.3	11.0	4.6	15	10.0	10.0	5.0	1.4	1.5	25.0			
ST2N1/4-PT1/8	1/4	R1/8	20.5	18.5	20.5	39.0	27.5	26.3	11.0	4.6	15	10.0	12.0	5.0	2.2	3.5	30.0			
ST2N1/4-PT1/4	1/4	R1/4	23.0	22.0	23.0	45.0	30.0	30.0	12.0	4.6	15	12.0	12.0	7.0	2.2	3.5	43.0			
ST2N5/16-PT1/8	5/16	R1/8	22.8	21.0	22.8	43.8	30.9	29.8	11.0	4.6	16	12.0	14.0	5.0	2.9	5.0	45.0			
ST2N5/16-PT1/4	5/16	R1/4	22.8	22.0	22.8	44.8	30.9	29.8	12.0	4.6	16	12.0	14.0	7.0	2.9	5.0	47.0			
ST2N3/8-PT1/4	3/8	R1/4	23.7	22.0	23.7	45.7	33.5	30.6	12.0	4.6	17	12.0	17.0	7.0	3.5	7.5	58.0			
ST2N3/8-PT3/8	3/8	R3/8	26.7	26.0	26.7	52.7	36.5	34.8	13.0	4.6	17	14.0	17.0	9.0	3.5	7.5	77.0			
ST2N1/2-PT3/8	1/2	R3/8	27.8	26.0	27.8	53.8	38.8	35.9	13.0	4.6	18	14.0	19.0	9.0	5.2	18.0	78.0			

☆C2N1/8-PT1/8 is of insertless type.

*Made to order

Tubing

Clean tubing

Processed tubing

PushOne fitting

QuickSeal fitting

Clean fitting/Chemifit

Bamboo-shoot fitting

Control switch/Detachable series

Jig/Tool/Accessory

Technical information

Reference

QuickSeal Series Insertion Type (brass)

Internal connector

●Millimeter size type (Group 4)

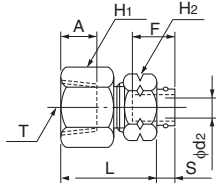

Product number	Applicable tubing outer diameter x inner diameter (mm)	T Thread size (RC)	L (mm)	A (mm)	S (mm)	F Tubing insertion length (mm)	H1 Width across flat (mm)	H2 Width across flat (mm)	d2 Min. inner diameter (mm)	Effective sectional area (mm ²)	Weight (g)
FC4N4x2-PT1/8	4x2	RC1/8	25.0	8.7	4.7	15	14.0	10.0	0.9	0.5	18.0
FC4N4x3-PT1/8	4x3	RC1/8	25.0	8.7	4.7	15	14.0	10.0	2.0	3.0	18.0
FC4N6x4-PT1/8	6x4	RC1/8	25.0	8.7	4.6	15	14.0	12.0	2.7	5.0	20.0
FC4N6x4-PT1/4	6x4	RC1/4	29.0	13.0	4.6	15	17.0	12.0	2.7	5.0	29.0
FC4N6x4-PT3/8	6x4	RC3/8	30.0	13.5	4.6	15	22.0	12.0	2.7	5.0	43.0
FC4N6x4.5-PT1/8	6x4.5	RC1/8	25.0	8.7	4.6	15	14.0	12.0	3.2	7.5	20.0
FC4N6x4.5-PT1/4	6x4.5	RC1/4	29.0	13.0	4.6	15	17.0	12.0	3.2	7.5	29.0
FC4N8x6-PT1/8	8x6	RC1/8	24.9	8.7	4.6	16	14.0	14.0	4.7	16.0	22.0
FC4N8x6-PT1/4	8x6	RC1/4	28.9	13.0	4.6	16	17.0	14.0	4.7	16.0	31.0
FC4N8x6-PT3/8	8x6	RC3/8	29.9	13.5	4.6	16	22.0	14.0	4.7	16.0	48.0
FC4N10x7.5-PT1/4	10x7.5	RC1/4	30.1	13.0	4.2	17	17.0	17.0	6.2	30.0	35.0
FC4N10x7.5-PT3/8	10x7.5	RC3/8	31.1	13.5	4.2	17	22.0	17.0	6.2	30.0	51.0
FC4N10x7.5-PT1/2	10x7.5	RC1/2	35.1	17.5	4.2	17	24.0	17.0	6.2	30.0	59.0
FC4N10x8-PT1/4	10x8	RC1/4	30.1	13.0	4.2	17	17.0	17.0	6.7	32.0	35.0
FC4N10x8-PT3/8	10x8	RC3/8	31.1	13.5	4.2	17	22.0	17.0	6.7	32.0	51.0
FC4N10x8-PT1/2	10x8	RC1/2	35.1	17.5	4.2	17	24.0	17.0	6.7	32.0	58.0
FC4N12x9-PT3/8	12x9	RC3/8	31.6	13.5	4.8	18	22.0	19.0	7.6	40.0	55.0
FC4N12x9-PT1/2	12x9	RC1/2	35.6	17.5	4.8	18	24.0	19.0	7.6	40.0	62.0

*Made to order

●Inch size type (Group 1)

Product number	Applicable tubing outer diameter (inch)	T Thread size (RC)	L (mm)	A (mm)	S (mm)	F Tubing insertion length (mm)	H1 Width across flat (mm)	H2 Width across flat (mm)	d2 Min. inner diameter (mm)	Effective sectional area (mm ²)	Weight (g)
FC1N3/16-PT1/8	3/16	RC1/8	25.1	8.7	4.6	15	14.0	10.0	2.4	4.0	17.0
FC1N1/4-PT1/8	1/4	RC1/8	25.0	8.7	4.6	15	14.0	12.0	3.4	8.5	19.0
FC1N1/4-PT1/4	1/4	RC1/4	29.0	13.0	4.6	15	17.0	12.0	3.4	8.5	29.0
FC1N5/16-PT1/8	5/16	RC1/8	24.8	8.7	4.6	16	14.0	14.0	4.7	16.0	22.0
FC1N5/16-PT1/4	5/16	RC1/4	28.8	13.0	4.6	16	17.0	14.0	4.7	16.0	30.0
FC1N5/16-PT3/8	5/16	RC3/8	29.8	13.5	4.6	16	22.0	14.0	4.7	16.0	45.0
FC1N3/8-PT1/4	3/8	RC1/4	29.7	13.0	4.6	17	17.0	17.0	5.7	22.5	35.0
FC1N3/8-PT3/8	3/8	RC3/8	30.7	13.5	4.6	17	22.0	17.0	5.7	22.5	52.0
FC1N3/8-PT1/2	3/8	RC1/2	34.7	17.5	4.6	17	24.0	17.0	5.7	22.5	60.0
FC1N1/2-PT3/8	1/2	RC3/8	31.8	13.5	4.6	18	22.0	19.0	8.2	45.0	54.0
FC1N1/2-PT1/2	1/2	RC1/2	35.8	17.5	4.6	18	24.0	19.0	8.2	45.0	61.0

Union connector

●Millimeter size type (Group 4)

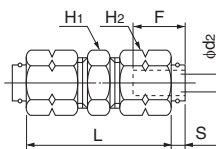

Product number	Applicable tubing outer diameter (mm)	L (mm)	S (mm)	F Tubing insertion length (mm)	H1 Width across flat (mm)	H2 Width across flat (mm)	d2 Min. inner diameter (mm)	Effective sectional area (mm ²)	Weight (g)
UC4N4x2	4x2	32.9	4.7	15	10.0	10.0	0.9	0.5	16.0
UC4N4x2.5	4x2.5	32.9	4.7	15	10.0	10.0	1.3	1.5	16.0
UC4N4x3	4x3	32.9	4.7	15	10.0	10.0	2.0	3.0	16.0
UC4N6x4	6x4	33.0	4.6	15	10.0	12.0	2.7	5.0	20.0
UC4N6x4.5	6x4.5	33.0	4.6	15	10.0	12.0	3.2	7.5	20.0
UC4N8x5	8x5	32.8	4.6	16	12.0	14.0	3.7	10.0	28.0
UC4N8x6	8x6	32.8	4.6	16	12.0	14.0	4.7	16.0	25.0
UC4N10x6.5	10x6.5	36.2	4.2	17	17.0	17.0	5.2	20.5	44.0
UC4N10x7.5	10x7.5	36.2	4.2	17	17.0	17.0	6.2	30.0	45.0
UC4N10x8	10x8	36.2	4.2	17	17.0	17.0	6.7	32.0	44.0
UC4N12x8	12x8	37.3	4.8	18	17.0	19.0	6.6	32.0	49.0
UC4N12x9	12x9	37.3	4.8	18	17.0	19.0	7.6	40.0	51.0

●Inch size type (Group 1)

Product number	Applicable tubing outer diameter (inch)	L (mm)	S (mm)	F Tubing insertion length (mm)	H1 Width across flat (mm)	H2 Width across flat (mm)	d2 Min. inner diameter (mm)	Effective sectional area (mm ²)	Weight (g)
UC1N1/8	1/8	33.1	4.6	15	10.0	8.0	1.4	1.5	13.0
UC1N3/16	3/16	33.1	4.6	15	10.0	10.0	2.4	4.0	16.0
UC1N1/4	1/4	33.1	4.6	15	10.0	12.0	3.4	8.5	20.0
UC1N5/16	5/16	32.7	4.6	16	12.0	14.0	4.7	16.0	25.0
UC1N3/8	3/8	35.4	4.6	17	14.0	17.0	5.7	22.5	40.0
UC1N1/2	1/2	37.6	4.6	18	17.0	19.0	8.2	45.0	47.0

Tubing

Clean tubing

Processed tubing

PushOne fitting

QuickSeal fitting

Clean fitting/Chemifit

Bamboo-shoot fitting

Control switch/Detachable series

Jig/Tool/Accessory

Technical information

Reference

90 degree union elbow

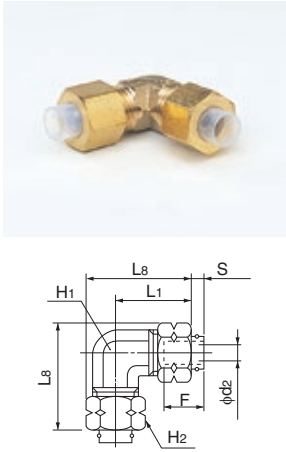

●Millimeter size type (Group 4)

Product number	Applicable tubing outer diameter x inner diameter (mm)	L1 (mm)	L8 (mm)	S (mm)	F Tubing insertion length (mm)	H1 Width across flat (mm)	H2 Width across flat (mm)	d2 Min. inner diameter (mm)	Effective sectional area (mm ²)	Weight (g)
UL4N4x2	4x2	20.5	26.2	4.7	15	10.0	10.0	0.9	0.6	20.0
UL4N4x2.5	4x2.5	20.5	26.2	4.7	15	10.0	10.0	1.3	1.0	20.0
UL4N4x3	4x3	20.5	26.2	4.7	15	10.0	10.0	2.0	2.0	20.0
UL4N6x4	6x4	20.5	27.4	4.6	15	10.0	12.0	2.7	4.0	25.0
UL4N6x4.5	6x4.5	20.5	27.4	4.6	15	10.0	12.0	3.2	5.5	25.0
UL4N8x5	8x5	22.9	31.0	4.6	16	12.0	14.0	3.7	7.5	37.0
UL4N8x6	8x6	22.9	31.0	4.6	16	12.0	14.0	4.7	12.5	36.0
UL4N10x6.5	10x6.5	27.1	36.9	4.2	17	14.0	17.0	5.2	15.5	59.0
UL4N10x7.5	10x7.5	27.1	36.9	4.2	17	14.0	17.0	6.2	22.0	56.0
UL4N10x8	10x8	27.1	36.9	4.2	17	14.0	17.0	6.7	25.0	57.0
UL4N12x8	12x8	27.6	38.6	4.8	18	14.0	19.0	6.6	25.0	63.0
UL4N12x9	12x9	27.6	38.6	4.8	18	14.0	19.0	7.6	25.0	60.0

●Inch size type (Group 1)

Product number	Applicable tubing outer diameter (inch)	L1 (mm)	L8 (mm)	S (mm)	F Tubing insertion length (mm)	H1 Width across flat (mm)	H2 Width across flat (mm)	d2 Min. inner diameter (mm)	Effective sectional area (mm ²)	Weight (g)
UL1N1/8	1/8	20.5	26.3	4.6	15	10.0	8.0	1.4	1.0	17.0
UL1N3/16	3/16	20.6	26.3	4.6	15	10.0	10.0	2.4	3.0	20.0
UL1N1/4	1/4	20.5	27.5	4.6	15	10.0	12.0	3.4	6.5	25.0
UL1N5/16	5/16	22.8	30.9	4.6	16	12.0	14.0	4.7	12.5	37.0
UL1N3/8	3/8	23.7	33.5	4.6	17	12.0	17.0	5.7	18.5	47.0
UL1N1/2	1/2	27.8	38.8	4.6	18	14.0	19.0	8.2	30.0	58.0

Union tee

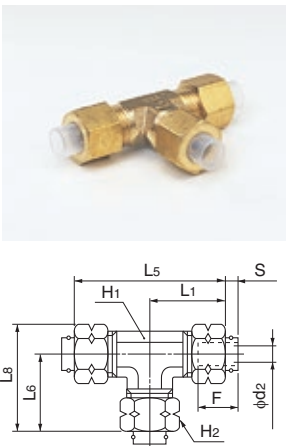

●Millimeter size type (Group 4)

Product number	Applicable tubing outer diameter x inner diameter (mm)	L1 (mm)	L5 (mm)	L6 (mm)	L8 (mm)	S (mm)	F Tubing insertion length (mm)	H1 Width across flat (mm)	H2 Width across flat (mm)	d2 Min. inner diameter (mm)	Effective sectional area (mm ²)	Weight (g)
UT4N4x2	4x2	20.5	40.9	20.5	26.2	4.7	15	10.0	10.0	0.9	0.6	27.0
UT4N4x2.5	4x2.5	20.5	40.9	20.5	26.2	4.7	15	10.0	10.0	1.3	1.0	28.0
UT4N4x3	4x3	20.5	40.9	20.5	26.2	4.7	15	10.0	10.0	2.0	2.0	26.0
UT4N6x4	6x4	20.5	41.0	20.5	27.4	4.6	15	10.0	12.0	2.7	4.0	35.0
UT4N6x4.5	6x4.5	20.5	41.0	20.5	27.4	4.6	15	10.0	12.0	3.2	5.5	35.0
UT4N8x5	8x5	22.9	45.8	22.9	31.0	4.6	16	12.0	14.0	3.7	7.5	49.0
UT4N8x6	8x6	22.9	45.8	22.9	31.0	4.6	16	12.0	14.0	4.7	12.5	48.0
UT4N10x6.5	10x6.5	27.1	54.2	27.1	36.9	4.2	17	14.0	17.0	5.2	15.5	82.0
UT4N10x7.5	10x7.5	27.1	54.2	27.1	36.9	4.2	17	14.0	17.0	6.2	22.0	80.0
UT4N10x8	10x8	27.1	54.2	27.1	36.9	4.2	17	14.0	17.0	6.7	25.0	77.0
UT4N12x8	12x8	27.6	55.3	28.6	39.6	4.8	18	14.0	19.0	6.6	25.0	90.0
UT4N12x9	12x9	27.6	55.3	28.6	39.6	4.8	18	14.0	19.0	7.6	25.0	85.0

●Inch size type (Group 1)

Product number	Applicable tubing outer diameter (inch)	L1 (mm)	L5 (mm)	L6 (mm)	L8 (mm)	S (mm)	F Tubing insertion length (mm)	H1 Width across flat (mm)	H2 Width across flat (mm)	d2 Min. inner diameter (mm)	Effective sectional area (mm ²)	Weight (g)
UT1N1/8	1/8	20.5	41.1	20.5	26.3	4.6	15	10.0	8.0	1.4	1.0	22.0
UT1N3/16	3/16	20.6	41.1	20.6	26.3	4.6	15	10.0	10.0	2.4	3.0	28.0
UT1N1/4	1/4	20.5	41.1	20.5	27.5	4.6	15	10.0	12.0	3.4	6.5	34.0
UT1N5/16	5/16	22.8	45.7	22.8	30.9	4.6	16	12.0	14.0	4.7	12.5	49.0
UT1N3/8	3/8	23.7	47.4	23.7	33.5	4.6	17	12.0	17.0	5.7	18.5	64.0
UT1N1/2	1/2	27.8	55.6	27.8	38.8	4.6	18	14.0	19.0	8.2	30.0	84.0
UT1N5/8	5/8	36.7	73.3	35.5	51.1	5.1	23	18.0	27.0	9.3	45.0	189.0

●Inch size type (Group 2)

Product number	Applicable tubing outer diameter (inch)	L1 (mm)	L5 (mm)	L6 (mm)	L8 (mm)	S (mm)	F Tubing insertion length (mm)	H1 Width across flat (mm)	H2 Width across flat (mm)	d2 Min. inner diameter (mm)	Effective sectional area (mm ²)	Weight (g)
☆ UT2N1/8	1/8	20.5	41.1	20.5	26.3	4.6	21	10.0	8.0	3.0	1.0	21.0
UT2N3/16	3/16	20.6	41.1	20.6	26.3	4.6	15	10.0	10.0	1.4	1.0	27.0
UT2N1/4	1/4	20.5	41.1	20.5	27.5	4.6	15	10.0	12.0	2.2	2.5	34.0
UT2N5/16	5/16	22.8	45.7	22.8	30.9	4.6	16	12.0	14.0	2.9	4.5	52.0
UT2N3/8	3/8	23.7	47.4	23.7	33.5	4.6	17	12.0	17.0	3.5	7.0	67.0
UT2N1/2	1/2	27.8	55.6	27.8	38.8	4.6	18	14.0	19.0	5.2	16.0	92.0

☆UT2N1/8 is of insertless type.

Tubing

Clean tubing

Processed tubing

PushOne fitting

QuickSeal fitting

Clean fitting/ Chemifit

Bamboo-shoot fitting

Control switch/ Detachable series

Jig/Tool/ Accessory

Technical information

Reference

Swivel nut internal connector

●Millimeter size type (Group 4)

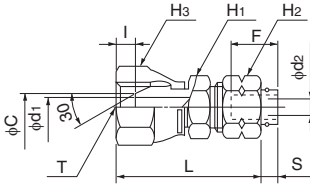

Product number	Applicable tubing outer diameter/inner diameter (mm)	T Thread size (G)	L (mm)	S (mm)	I (mm)	F Tubing insertion length (mm)	H1 Width across flat (mm)	H2 Width across flat (mm)	H3 Width across flat (mm)	C (mm)	d1 (mm)	d2 Min. inner diameter (mm)	Effective sectional area (mm ²)	Weight (g)
SC4N4x2-PF1/8	4x2	G1/8	33.0	4.7	4.0	15	12.0	10.0	14.0	5.0	2.8	0.9	1.0	24.0
SC4N6x4-PF1/8	6x4	G1/8	33.0	4.6	4.0	15	12.0	12.0	14.0	5.0	2.7	2.7	5.0	26.0
SC4N6x4-PF1/4	6x4	G1/4	34.7	4.6	5.7	15	17.0	12.0	19.0	7.0	5.0	2.7	5.5	44.0
SC4N6x4.5-PF1/8	6x4.5	G1/8	33.0	4.6	4.0	15	12.0	12.0	14.0	5.0	3.2	3.2	6.5	26.0
SC4N6x4.5-PF1/4	6x4.5	G1/4	34.7	4.6	5.7	15	17.0	12.0	19.0	7.0	5.0	3.2	7.5	44.0
SC4N8x6-PF1/4	8x6	G1/4	34.6	4.6	5.7	16	17.0	14.0	19.0	7.0	5.0	4.7	17.0	46.0
SC4N10x7.5-PF1/4	10x7.5	G1/4	38.8	4.2	5.7	17	17.0	17.0	19.0	7.0	5.0	6.2	19.0	56.0
SC4N10x7.5-PF3/8	10x7.5	G3/8	40.9	4.2	6.8	17	19.0	17.0	22.0	10.0	6.2	6.2	19.0	71.0
SC4N10x8-PF1/4	10x8	G1/4	38.8	4.2	5.7	17	17.0	17.0	19.0	7.0	5.0	6.7	19.0	56.0
SC4N10x8-PF3/8	10x8	G3/8	40.9	4.2	6.8	17	19.0	17.0	22.0	10.0	6.7	6.7	34.0	71.0
SC4N12x9-PF3/8	12x9	G3/8	41.4	4.8	6.8	18	19.0	19.0	22.0	10.0	7.6	7.6	44.5	54.0
SC4N12x9-PF1/2	12x9	G1/2	46.1	4.8	9.5	18	22.0	19.0	27.0	14.0	10.0	7.6	44.5	116.0

*Made to order

●Inch size type (Group 1)

Product number	Applicable tubing outer diameter (inch)	T Thread size (G)	L (mm)	S (mm)	I (mm)	F Tubing insertion length (mm)	H1 Width across flat (mm)	H2 Width across flat (mm)	H3 Width across flat (mm)	C (mm)	d1 (mm)	d2 Min. inner diameter (mm)	Effective sectional area (mm ²)	Weight (g)
SC1N1/8-PF1/8	1/8	G1/8	33.0	4.6	4.0	15	12.0	8.0	14.0	5.0	1.4	1.4	1.5	22.0
SC1N3/16-PF1/8	3/16	G1/8	33.1	4.6	4.0	15	12.0	10.0	14.0	5.0	2.4	2.4	4.0	24.0
SC1N1/4-PF1/8	1/4	G1/8	33.0	4.6	4.0	15	12.0	12.0	14.0	5.0	3.4	3.4	6.5	25.0
SC1N1/4-PF1/4	1/4	G1/4	34.7	4.6	5.7	15	17.0	12.0	19.0	7.0	5.0	3.4	8.5	44.0
SC1N5/16-PF1/4	5/16	G1/4	34.5	4.6	5.7	16	17.0	14.0	19.0	7.0	5.0	4.7	16.5	45.0
SC1N3/8-PF1/4	3/8	G1/4	38.4	4.6	5.7	17	17.0	17.0	19.0	7.0	5.7	5.7	24.0	55.0
SC1N3/8-PF3/8	3/8	G3/8	40.5	4.6	6.8	17	19.0	17.0	22.0	10.0	5.7	5.7	24.0	72.0
SC1N1/2-PF3/8	1/2	G3/8	41.6	4.6	6.8	18	19.0	19.0	22.0	10.0	8.2	8.2	47.0	70.0
SC1N1/2-PF1/2	1/2	G1/2	46.3	4.6	9.5	18	22.0	19.0	27.0	14.0	10.0	8.2	49.0	104.0
SC1N5/8-PF1/2	5/8	G1/2	52.2	5.1	9.5	23	23.0	27.0	27.0	14.0	10.0	9.3	63.0	145.0

*Made to order

●Inch size type (Group 2)

Product number	Applicable tubing outer diameter (inch)	T Thread size (G)	L (mm)	S (mm)	I (mm)	F Tubing insertion length (mm)	H1 Width across flat (mm)	H2 Width across flat (mm)	H3 Width across flat (mm)	C (mm)	d1 (mm)	d2 Min. inner diameter (mm)	Effective sectional area (mm ²)	Weight (g)
SC2N1/4-PF1/8	1/4	G1/8	33.0	4.6	4.0	15	12.0	12.0	14.0	5.0	2.2	2.2	3.5	25.5
SC2N1/4-PF1/4	1/4	G1/4	34.7	4.6	5.7	15	17.0	12.0	19.0	7.0	5.0	2.2	3.5	44.0
SC2N5/16-PF1/4	5/16	G1/4	34.5	4.6	5.7	16	17.0	14.0	19.0	7.0	5.0	2.9	6.0	45.0
SC2N3/8-PF3/8	3/8	G3/8	40.5	4.6	6.8	17	19.0	17.0	22.0	10.0	5.7	3.5	7.0	72.0
SC2N1/2-PF3/8	1/2	G3/8	41.6	4.6	6.8	18	19.0	19.0	22.0	10.0	5.7	5.2	20.5	70.0

Panel touch connector

●Millimeter size type (Group 4)

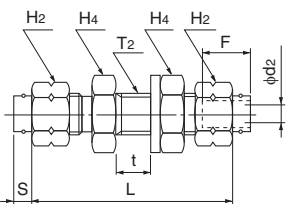

Product number	Applicable tubing outer diameter/inner diameter (mm)	L (mm)	S (mm)	F Tubing insertion length (mm)	t Max. panel thickness (mm)	H2 Width across flat (mm)	H4 Width across flat (mm)	d2 Min. inner diameter (mm)	T2 Recommended panel hole diameter (mm)	Washer outer diameter (mm)	Washer thickness (mm)	Effective sectional area (mm ²)	Weight (g)
UCT4N4x2	4x2	41.5	4.7	15	8.0	10.0	12.0	0.9	9	15	1.6	0.7	25.0
UCT4N4x3	4x3	41.5	4.7	15	8.0	10.0	12.0	2.0	9	15	1.6	3.0	25.0
UCT4N6x4	6x4	42.0	4.6	15	8.4	12.0	14.0	2.7	11	18	1.6	5.0	33.0
UCT4N6x4.5	6x4.5	42.0	4.6	15	8.4	12.0	14.0	3.2	11	18	1.6	7.5	33.0
UCT4N8x6	8x6	43.3	4.6	16	8.4	14.0	17.0	4.7	13	20	2.0	16.0	48.0
UCT4N10x7.5	10x7.5	45.7	4.2	17	8.1	17.0	19.0	6.2	16	24	2.5	30.0	67.0
UCT4N10x8	10x8	45.7	4.2	17	8.1	17.0	19.0	6.7	16	24	2.5	32.0	67.0
UCT4N12x9	12x9	47.3	4.8	18	8.1	19.0	22.0	7.6	18	28	2.5	40.0	87.0

*Made to order

●Inch size type (Group 1)

Product number	Applicable tubing outer diameter (inch)	L (mm)	S (mm)	F Tubing insertion length (mm)	t Max. panel thickness (mm)	H2 Width across flat (mm)	H4 Width across flat (mm)	d2 Min. inner diameter (mm)	T2 Recommended panel hole diameter (mm)	Washer outer diameter (mm)	Washer thickness (mm)	Effective sectional area (mm ²)	Weight (g)
UCT1N1/8	1/8	39.7	4.6	15	8.0	8.0	10.0	1.4	7	11	1.6	1.5	14.5
UCT1N3/16	3/16	41.7	4.6	15	8.0	10.0	12.0	2.4	9	15	1.6	4.0	25.0
UCT1N1/4	1/4	42.1	4.6	15	8.4	12.0	14.0	3.4	11	18	1.6	8.5	32.0
UCT1N5/16	5/16	43.2	4.6	16	8.3	14.0	17.0	4.7	13	20	2.0	16.0	49.0
UCT1N3/8	3/8	44.9	4.6	17	7.7	17.0	19.0	5.7	15	24	2.5	22.5	67.0
UCT1N1/2	1/2	47.6	4.6	18	7.8	19.0	22.0	8.2	18	28	2.5	45.0	86.0

*Made to order

Tubing
 Clean tubing
 Processed tubing
 PushOne fitting
 QuickSeal fitting
 Clean fitting/ Chemifit
 Bamboo-shoot fitting
 Control switch/ Detachable series
 Jig/Tool/ Accessory
 Technical information
 Reference

Brass nut

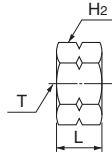

*The inch size type has no cut.

●Millimeter size type (Group 4)

Product number	Applicable tubing outer diameter (mm)	T Thread size (M)	L (mm)	H ₂ Width across flat (mm)	Weight (g)
N4	4	M8×0.75	9.0	10.0	4.0
N6	6	M10×1.0	9.0	12.0	5.0
N8	8	M12×1.0	9.0	14.0	6.0
N10	10	M15×1.0	10.0	17.0	9.0
N12	12	M17×1.0	11.0	19.0	11.0
N16	16	M22×1.0	13.0	27.0	33.0

●Inch size type (Group 1)

Product number	Applicable tubing outer diameter (inch)	T Thread size (M)	L (mm)	H ₂ Width across flat (mm)	Weight (g)
N1/8	1/8	M6×0.75	9.0	8.0	3.0
N3/16	3/16	M8×0.75	9.0	10.0	4.0
N1/4	1/4	M10×1.0	9.0	12.0	5.0
N5/16	5/16	M12×1.0	9.0	14.0	6.0
N3/8	3/8	M14×1.0	10.0	17.0	10.0
N1/2	1/2	M17×1.0	11.5	19.0	11.0
N5/8	5/8	M22×1.0	13.0	27.0	33.0

Nylon sleeve

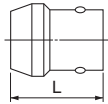

⚠ Caution: Nylon sleeves that have been used once cannot be reused.

●Millimeter size type (Color: milky white)

Product number	Applicable tubing outer diameter (inch)	L (mm)	Weight (g)
SN4	4	11.0	0.2
SN6	6	11.0	0.2
SN8	8	11.0	0.3
SN10	10	12.0	0.4
SN12	12	13.0	0.5
SN16	16	17.0	1.1

●Inch size type (Color: black)

Product number	Applicable tubing outer diameter (inch)	L (mm)	Weight (g)
SN1/8	1/8	11.0	0.1
SN3/16	3/16	11.0	0.2
SN1/4	1/4	11.0	0.2
SN5/16	5/16	11.0	0.3
SN3/8	3/8	12.0	0.4
SN1/2	1/2	13.0	0.5
SN5/8	5/8	17.0	1.1

Brass sleeve

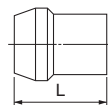

⚠ Caution: Brass sleeves that have been used once cannot be reused.

●Millimeter size type

Product number	Applicable tubing outer diameter (inch)	L (mm)	Weight (g)
MSN4	4	9.0	0.7
MSN6	6	9.0	1.0
MSN8	8	9.0	1.3
MSN10	10	10.0	2.1
MSN12	12	11.3	2.8
MSN16	16	17.0	6.7

●Inch size type

Product number	Applicable tubing outer diameter (inch)	L (mm)	Weight (g)
MSN1/8	1/8	11.0	0.6
MSN3/16	3/16	11.0	0.9
MSN1/4	1/4	11.0	1.2
MSN5/16	5/16	11.0	1.7
MSN3/8	3/8	12.0	2.4
MSN1/2	1/2	13.0	3.4

Connector (NPT thread)

●Inch size type (Group 1) NPT thread

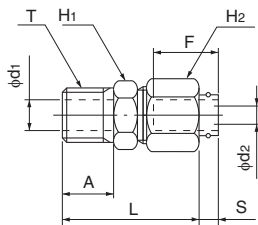

Product number	Applicable tubing outer diameter (inch)	T Thread size (NPT)	L (mm)	A (mm)	S (mm)	F Tubing insertion length (mm)	H ₁ Width across flat (mm)	H ₂ Width across flat (mm)	d ₁ (mm)	d ₂ Min. inner diameter (mm)	Effective sectional area (mm ²)	Weight (g)
* C1N1/8-NPT1/8	1/8	NPT1/8	28.0	11.0	4.6	15	12.0	8.0	5.0	1.4	1.5	11.0
* C1N3/16-NPT1/8	3/16	NPT1/8	28.1	11.0	4.6	15	12.0	10.0	5.0	2.4	4.0	13.0
* C1N1/4-NPT1/8	1/4	NPT1/8	28.0	11.0	4.6	15	12.0	12.0	5.0	3.4	8.5	14.0
* C1N1/4-NPT1/4	1/4	NPT1/4	30.0	12.0	4.6	15	14.0	12.0	7.0	3.4	8.5	22.0
* C1N5/16-NPT1/8	5/16	NPT1/8	28.8	11.0	4.6	16	14.0	14.0	5.0	4.7	16.0	17.0
* C1N5/16-NPT1/4	5/16	NPT1/4	29.8	12.0	4.6	16	14.0	14.0	7.0	4.7	16.0	24.0
* C1N3/8-NPT1/4	3/8	NPT1/4	30.7	12.0	4.6	17	14.0	17.0	7.5	5.7	22.5	28.0
* C1N3/8-NPT3/8	3/8	NPT3/8	31.7	13.0	4.6	17	17.0	17.0	9.0	5.7	22.5	39.0
* C1N1/2-NPT1/4	1/2	NPT1/4	31.8	12.0	4.6	18	17.0	19.0	8.2	8.2	45.0	33.0
* C1N1/2-NPT3/8	1/2	NPT3/8	32.8	13.0	4.6	18	17.0	19.0	9.0	8.2	45.0	40.0
* C1N1/2-NPT1/2	1/2	NPT1/2	40.8	18.0	4.6	18	23.0	19.0	12.0	8.2	45.0	72.0

*Made to order

⚠ Connector (NPT thread) is not sealed.

90 degree elbow (NPT thread)

●Inch size type (Group 1) NPT thread

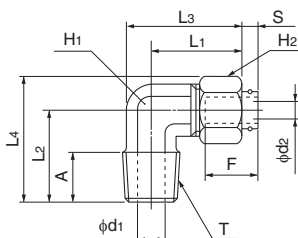

Product number	Applicable tubing outer diameter (inch)	T Thread size (NPT)	L ₁ (mm)	L ₂ (mm)	L ₃ (mm)	L ₄ (mm)	A (mm)	S (mm)	F Tubing insertion length (mm)	H ₁ Width across flat (mm)	H ₂ Width across flat (mm)	d ₁ (mm)	d ₂ Min. inner diameter (mm)	Effective sectional area (mm ²)	Weight (g)
* L1N3/16-NPT1/8	3/16	NPT1/8	20.6	18.5	26.3	24.3	11.0	4.6	15	10.0	10.0	5.0	2.4	4.0	18.0
* L1N1/4-NPT1/8	1/4	NPT1/8	20.5	18.5	26.3	25.4	11.0	4.6	15	10.0	12.0	5.0	3.4	8.0	20.0
* L1N1/4-NPT1/4	1/4	NPT1/4	23.0	22.0	28.8	28.9	12.0	4.6	15	10.0	12.0	7.0	3.4	8.0	26.0
* L1N5/16-NPT1/8	5/16	NPT1/8	22.8	21.0	29.8	29.1	11.0	4.6	16	12.0	14.0	5.0	4.7	15.0	30.0
* L1N5/16-NPT1/4	5/16	NPT1/4	22.8	22.0	29.8	30.1	12.0	4.6	16	12.0	14.0	7.0	4.7	15.0	32.0
* L1N3/8-NPT1/4	3/8	NPT1/4	23.7	22.0	30.6	31.8	12.0	4.6	17	12.0	17.0	7.0	5.7	19.0	50.0
* L1N3/8-NPT3/8	3/8	NPT3/8	26.7	26.0	33.6	35.8	13.0	4.6	17	12.0	17.0	7.0	5.7	19.0	50.0
* L1N1/2-NPT1/4	1/2	NPT1/4	27.8	25.0	35.9	36.0	12.0	4.6	18	14.0	19.0	7.0	8.2	32.0	50.0
* L1N1/2-NPT3/8	1/2	NPT3/8	27.8	26.0	35.9	37.0	13.0	4.6	18	14.0	19.0	9.0	8.2	32.0	53.0
* L1N1/2-NPT1/2	1/2	NPT1/2	30.3	33.0	38.4	44.0	18.0	4.6	18	14.0	19.0	10.0	8.2	32.0	76.0

*Made to order

Tubing

Clean tubing

Processed tubing

PushOne fitting

QuickSeal fitting

Clean fitting/ Chemifit

Bamboo-shoot fitting

Control switch/ Detachable series

Jig/Tool/ Accessory

Technical information

Reference

Reference

Technical information

Jig/Tool/
Accessory

Control switch/
Detachable
series

Bambo-
shoot fitting

Clean fitting/
Chemifit

**QuickSeal
fitting**

PushOne
fitting

Processed
tubing

Clean
tubing

Tubing

Insertion Type (stainless)

Screw-in type for multi-purpose piping (made of SUS304)

Features

- **Screw-in type**
Consisting of three parts: fitting body, nut and sleeve.
- **High sealing performance**
The insertion part is integrated with a fitting body with high negative-pressure performance.
- **Made of SUS304 with high corrosion resistance**
- **JIS B 8381-1995 (fittings for pneumatic flexible pipes) compliant**



Cross-sectional structure diagram

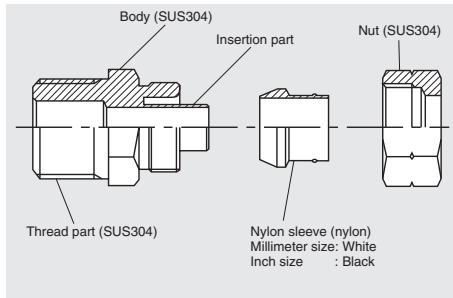

Sealing mechanism

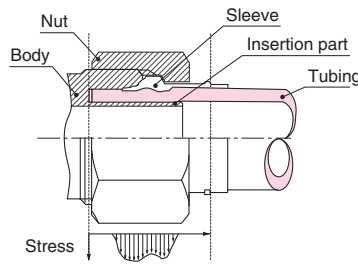

Operating fluid, working temperature range

Operating fluid	Nylon sleeve	Working temperature range
Air	Nylon sleeve	-40°C~+80°C
Water	Nylon sleeve	0°C~+70°C
General operating oil	Nylon sleeve	-40°C~+80°C

☞ Contact us for various chemical liquids.
☞ See "Combination List of Tubing and Fitting" on page 8.

Pressure condition

Maximum working pressure: 5.0MPa
Negative pressure performance:
-101.294kPa

Handling instructions

- ⚠ **Caution:** When the working conditions of tubes and fittings differ, use them under the lower specified conditions.
 - ⚠ **Caution:** For use at a high temperature within the working temperature range, tighten the nut periodically. If the nut cannot be tightened further, cut the tubing end and insert the tubing again with a new sleeve.
 - ⚠ **Caution:** When water is used as the operating fluid, do not allow it to freeze.
 - ⚠ **Caution:** Do not bend the pipe sharply near the tubing insertion port (sleeve end) of the fitting. Keep the tubing straight for twice as long as the tubing diameter from the insertion port.
 - ⚠ **Caution:** The outer and the inner diameters of the fitting have to be the same as those of the tubing used.
- ☞ See page 34 for the common handling instructions for fittings.

Product number example

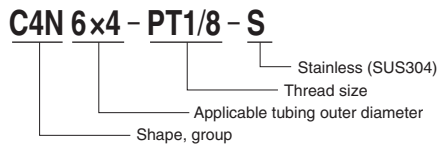

Distinction of millimeter/inch sizes



The inch size type has a black sleeve.
The millimeter size type has a cut at the hexagonal nut.

Applicable tubing

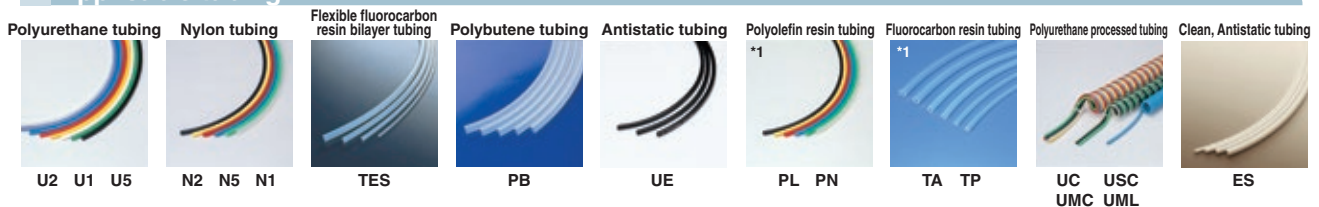

(*1) Combinatory use of PL, PN, TA, TP or ES tubing and QuickSeal series of insertion type (stainless) mixes general and clean type performances. When using them together in a clean environment, be aware of how this could lower the cleanliness level.

Related products and product introduction



Reference

Instruction manualP.172
Chemical resistance specification tableP.198
Effective sectional area ..P.168
Negative-pressure performance listP.169

QuickSeal Series Insertion Type (stainless)

Shape list



Tubing

Clean tubing

Processed tubing

PushOne fitting

QuickSeal fitting

Clean fitting/
Chemifit

Bamboo-shoot fitting

Control switch/
Detachable series

Jig/Tool/
Accessory

Technical information

Reference

QuickSeal Series Insertion Type (stainless)

Connector

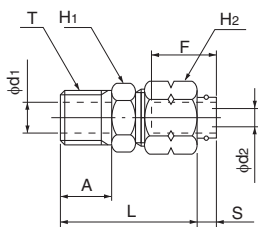

●Millimeter size type (Group 4)

Product number	Applicable tubing outer diameter (mm)	T Thread size (R)	L (mm)	A (mm)	S (mm)	F Tubing insertion length (mm)	H1 Width across flat (mm)	H2 Width across flat (mm)	d1 (mm)	d2 Min. inner diameter (mm)	Effective sectional area (mm ²)	Weight (g)
C4N6x4-PT1/8-S	6x4	R1/8	28.0	11.0	4.6	15	10.0	12.0	5.0	2.7	5.0	15.0
C4N6x4-PT1/4-S	6x4	R1/4	30.0	12.0	4.6	15	14.0	12.0	7.0	2.7	5.0	22.0
C4N8x5-PT1/8-S	8x5	R1/8	27.9	11.0	4.6	16	12.0	14.0	5.0	3.7	10.0	18.0
C4N8x5-PT1/4-S	8x5	R1/4	29.9	12.0	4.6	16	14.0	14.0	7.0	3.7	10.0	24.0
C4N8x6-PT1/8-S	8x6	R1/8	27.9	11.0	4.6	16	12.0	14.0	5.0	4.7	16.0	17.0
C4N8x6-PT1/4-S	8x6	R1/4	29.9	12.0	4.6	16	14.0	14.0	7.0	4.7	16.0	24.0
C4N10x6.5-PT1/4-S	10x6.5	R1/4	31.1	12.0	4.2	17	17.0	17.0	7.0	5.2	20.5	32.0
C4N10x6.5-PT3/8-S	10x6.5	R3/8	32.1	13.0	4.2	17	17.0	17.0	9.0	5.2	20.5	38.0
C4N10x8-PT1/4-S	10x8	R1/4	31.1	12.0	4.2	17	17.0	17.0	7.0	6.7	32.0	29.0
C4N10x8-PT3/8-S	10x8	R3/8	32.1	13.0	4.2	17	17.0	17.0	9.0	6.7	32.0	37.0
C4N12x8-PT3/8-S	12x8	R3/8	35.6	13.0	4.8	18	17.0	19.0	9.0	6.6	32.0	47.0
C4N12x8-PT1/2-S	12x8	R1/2	40.6	18.0	4.8	18	23.0	19.0	12.0	6.6	33.5	75.0
C4N12x9-PT3/8-S	12x9	R3/8	35.6	13.0	4.8	18	17.0	19.0	9.0	7.6	40.0	40.5
C4N12x9-PT1/2-S	12x9	R1/2	40.6	18.0	4.8	18	23.0	19.0	12.0	7.6	40.0	74.0

●Inch size type (Group 1)

Product number	Applicable tubing outer diameter (inch)	T Thread size (R)	L (mm)	A (mm)	S (mm)	F Tubing insertion length (mm)	H1 Width across flat (mm)	H2 Width across flat (mm)	d1 (mm)	d2 Min. inner diameter (mm)	Effective sectional area (mm ²)	Weight (g)
C1N1/4-PT1/8-S	1/4	R1/8	28.0	11.0	4.6	15	10.0	12.0	5.0	3.4	8.5	14.0
C1N1/4-PT1/4-S	1/4	R1/4	30.0	12.0	4.6	15	14.0	12.0	7.0	3.4	8.5	22.0
C1N5/16-PT1/8-S	5/16	R1/8	27.8	11.0	4.6	16	12.0	14.0	5.0	4.7	16.0	17.0
C1N5/16-PT1/4-S	5/16	R1/4	29.8	12.0	4.6	16	14.0	14.0	7.0	4.7	16.0	24.0
C1N3/8-PT1/8-S	3/8	R1/8	28.7	11.0	4.6	17	14.0	17.0	5.7	5.7	22.5	23.0
C1N3/8-PT1/4-S	3/8	R1/4	30.7	12.0	4.6	17	14.0	17.0	7.5	5.7	22.5	28.0
C1N3/8-PT3/8-S	3/8	R3/8	31.7	13.0	4.6	17	17.0	17.0	9.0	5.7	22.5	39.0
C1N1/2-PT1/4-S	1/2	R1/4	31.8	12.0	4.6	18	17.0	19.0	8.2	8.2	45.0	33.0
C1N1/2-PT3/8-S	1/2	R3/8	32.8	13.0	4.6	18	17.0	19.0	9.0	8.2	45.0	40.0
C1N1/2-PT1/2-S	1/2	R1/2	40.8	18.0	4.6	18	23.0	19.0	12.0	8.2	45.0	72.0

90 degree elbow

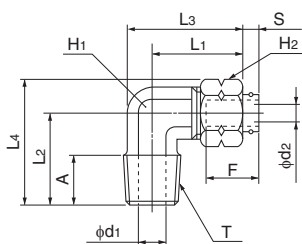

●Millimeter size type (Group 4)

Product number	Applicable tubing outer diameter (mm)	T Thread size (R)	L1 (mm)	L2 (mm)	L3 (mm)	L4 (mm)	A (mm)	S (mm)	F Tubing insertion length (mm)	H1 Width across flat (mm)	H2 Width across flat (mm)	d1 (mm)	d2 Min. inner diameter (mm)	Effective sectional area (mm ²)	Weight (g)
L4N6x4-PT1/8-S	6x4	R1/8	20.5	18.5	26.3	25.4	11.0	4.6	15	10.0	12.0	5.0	2.7	4.5	21.0
L4N6x4-PT1/4-S	6x4	R1/4	23.0	22.0	29.9	28.9	12.0	4.6	15	12.0	12.0	7.0	2.7	4.5	32.0
L4N8x5-PT1/8-S	8x5	R1/8	22.9	21.0	29.8	29.1	11.0	4.6	16	12.0	14.0	5.0	3.7	9.0	31.0
L4N8x5-PT1/4-S	8x5	R1/4	22.9	22.0	29.8	30.1	12.0	4.6	16	12.0	14.0	7.0	3.7	9.0	32.5
L4N8x6-PT1/8-S	8x6	R1/8	22.9	21.0	29.8	29.1	11.0	4.6	16	12.0	14.0	5.0	4.7	14.0	31.0
L4N8x6-PT1/4-S	8x6	R1/4	22.9	22.0	29.8	30.1	12.0	4.6	16	12.0	14.0	7.0	4.7	15.0	32.5
L4N10x6.5-PT1/4-S	10x6.5	R1/4	27.1	25.0	35.2	34.8	12.0	4.2	17	14.0	17.0	7.0	5.2	18.0	47.0
L4N10x6.5-PT3/8-S	10x6.5	R3/8	27.1	26.0	35.2	35.8	13.0	4.2	17	14.0	17.0	9.0	5.2	18.0	50.0
L4N10x8-PT1/4-S	10x8	R1/4	27.1	25.0	35.2	34.8	12.0	4.2	17	14.0	17.0	7.0	6.7	25.0	48.0
L4N10x8-PT3/8-S	10x8	R3/8	27.1	26.0	35.2	35.8	13.0	4.2	17	14.0	17.0	9.0	6.7	25.0	51.0
L4N12x8-PT3/8-S	12x8	R3/8	27.6	26.0	35.7	37.0	13.0	4.8	18	14.0	19.0	9.0	6.6	25.0	53.0
L4N12x8-PT1/2-S	12x8	R1/2	30.1	33.0	40.5	44.0	18.0	4.8	18	18.0	19.0	10.0	6.6	30.0	90.0
L4N12x9-PT3/8-S	12x9	R3/8	27.6	26.0	35.7	37.0	13.0	4.8	18	14.0	19.0	9.0	7.6	33.0	54.0
L4N12x9-PT1/2-S	12x9	R1/2	30.1	33.0	40.5	44.0	18.0	4.8	18	18.0	19.0	10.0	7.6	33.0	91.0

●Inch size type (Group 1)

Product number	Applicable tubing outer diameter (inch)	T Thread size (R)	L1 (mm)	L2 (mm)	L3 (mm)	L4 (mm)	A (mm)	S (mm)	F Tubing insertion length (mm)	H1 Width across flat (mm)	H2 Width across flat (mm)	d1 (mm)	d2 Min. inner diameter (mm)	Effective sectional area (mm ²)	Weight (g)
L1N1/4-PT1/8-S	1/4	R1/8	20.5	18.5	26.3	25.4	11.0	4.6	15	10.0	12.0	5.0	3.4	8.0	20.0
L1N1/4-PT1/4-S	1/4	R1/4	23.0	22.0	30.0	28.9	12.0	4.6	15	12.0	12.0	7.0	3.4	8.0	26.0
L1N5/16-PT1/8-S	5/16	R1/8	22.8	21.0	29.8	29.1	11.0	4.6	16	12.0	14.0	5.0	4.7	15.0	30.0
L1N5/16-PT1/4-S	5/16	R1/4	22.8	22.0	29.8	30.1	12.0	4.6	16	12.0	14.0	7.0	4.7	15.0	32.0
L1N3/8-PT1/8-S	3/8	R1/8	23.7	21.0	30.6	30.8	11.0	4.6	17	12.0	17.0	5.0	5.7	15.0	35.0
L1N3/8-PT1/4-S	3/8	R1/4	23.7	22.0	30.6	31.8	12.0	4.6	17	12.0	17.0	7.0	5.7	19.0	50.0
L1N3/8-PT3/8-S	3/8	R3/8	26.7	26.0	35.2	35.8	13.0	4.6	17	14.0	17.0	9.0	5.7	19.0	50.0
L1N1/2-PT1/4-S	1/2	R1/4	27.8	25.0	35.9	36.0	12.0	4.6	18	14.0	19.0	7.0	8.2	32.0	50.0
L1N1/2-PT3/8-S	1/2	R3/8	27.8	26.0	36.3	37.0	13.0	4.6	18	14.0	19.0	9.0	8.2	32.0	53.0
L1N1/2-PT1/2-S	1/2	R1/2	30.8	33.0	41.6	44.0	18.0	4.6	18	18.0	19.0	12.0	8.2	32.0	76.0

Tee

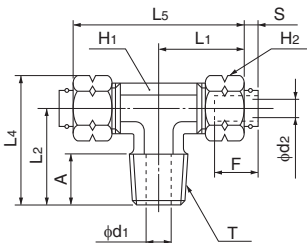

●Millimeter size type (Group 4)

Product number	Applicable tubing outer diameter (mm)	T Thread size (R)	L1 (mm)	L2 (mm)	L4 (mm)	L5 (mm)	A (mm)	S (mm)	F Tubing insertion length (mm)	H1 Width across flat (mm)	H2 Width across flat (mm)	d1 (mm)	d2 Min. inner diameter (mm)	Effective sectional area (mm ²)	Weight (g)
T4N6x4-PT1/8-S	6x4	R1/8	20.5	18.5	25.4	41.0	11.0	4.6	15	10.0	12.0	5.0	2.7	4.5	30.0
T4N6x4-PT1/4-S	6x4	R1/4	23.0	22.0	28.9	46.0	12.0	4.6	15	12.0	12.0	7.0	2.7	4.5	43.0
T4N8x5-PT1/8-S	8x5	R1/8	22.9	21.0	29.1	45.8	11.0	4.6	16	12.0	14.0	5.0	3.7	9.0	43.0
T4N8x5-PT1/4-S	8x5	R1/4	22.9	22.0	30.1	45.8	12.0	4.6	16	12.0	14.0	7.0	3.7	9.0	45.0
T4N8x6-PT1/8-S	8x6	R1/8	22.9	21.0	29.1	45.8	11.0	4.6	16	12.0	14.0	5.0	4.7	14.0	42.0
T4N8x6-PT1/4-S	8x6	R1/4	22.9	22.0	30.1	45.8	12.0	4.6	16	12.0	14.0	7.0	4.7	15.0	44.0
T4N10x6.5-PT1/4-S	10x6.5	R1/4	27.1	25.0	34.8	54.2	12.0	4.2	17	14.0	17.0	7.0	5.2	18.0	73.0
T4N10x6.5-PT3/8-S	10x6.5	R3/8	27.1	26.0	35.8	54.2	13.0	4.2	17	14.0	17.0	9.0	5.2	18.0	78.0
T4N10x8-PT1/4-S	10x8	R1/4	27.1	25.0	34.8	54.2	12.0	4.2	17	14.0	17.0	7.0	6.7	25.0	69.0
T4N10x8-PT3/8-S	10x8	R3/8	27.1	26.0	35.8	54.2	13.0	4.2	17	14.0	17.0	9.0	6.7	25.0	75.0
T4N12x8-PT3/8-S	12x8	R3/8	27.6	25.0	36.0	55.3	13.0	4.8	18	14.0	19.0	9.0	6.6	25.0	82.0
T4N12x9-PT3/8-S	12x9	R3/8	27.6	26.0	37.0	55.3	13.0	4.8	18	14.0	19.0	9.0	7.6	33.0	82.0

●Inch size type (Group 1)

Product number	Applicable tubing outer diameter (inch)	T Thread size (R)	L1 (mm)	L2 (mm)	L4 (mm)	L5 (mm)	A (mm)	S (mm)	F Tubing insertion length (mm)	H1 Width across flat (mm)	H2 Width across flat (mm)	d1 (mm)	d2 Min. inner diameter (mm)	Effective sectional area (mm ²)	Weight (g)
T1N1/4-PT1/8-S	1/4	R1/8	20.5	18.5	25.4	41.1	11.0	4.6	15	10.0	12.0	5.0	3.4	8.0	29.0
T1N1/4-PT1/4-S	1/4	R1/4	23.0	22.0	28.9	46.1	12.0	4.6	15	12.0	12.0	7.0	3.4	8.0	42.0
T1N3/8-PT1/4-S	3/8	R1/4	23.7	22.0	31.8	47.4	12.0	4.6	17	12.0	17.0	7.0	5.7	19.0	55.0

Service tee

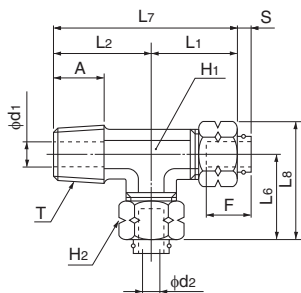

●Millimeter size type (Group 4)

Product number	Applicable tubing outer diameter (mm)	T Thread size (R)	L1 (mm)	L2 (mm)	L6 (mm)	L7 (mm)	L8 (mm)	A (mm)	S (mm)	F Tubing insertion length (mm)	H1 Width across flat (mm)	H2 Width across flat (mm)	d1 (mm)	d2 Min. inner diameter (mm)	Effective sectional area (mm ²)	Weight (g)
ST4N6x4-PT1/8-S	6x4	R1/8	20.5	18.5	20.5	39.0	27.4	11.0	4.6	15	10.0	12.0	5.0	2.7	4.5	41.0
ST4N6x4-PT1/4-S	6x4	R1/4	23.0	22.0	23.0	45.0	29.9	12.0	4.6	15	12.0	12.0	7.0	2.7	4.5	30.0
ST4N8x5-PT1/8-S	8x5	R1/8	22.9	21.0	22.9	43.9	31.0	11.0	4.6	16	12.0	14.0	5.0	3.7	9.0	43.0
ST4N8x5-PT1/4-S	8x5	R1/4	22.9	22.0	22.9	44.9	31.0	12.0	4.6	16	12.0	14.0	7.0	3.7	9.0	43.0
ST4N8x6-PT1/8-S	8x6	R1/8	22.9	21.0	22.9	43.9	31.0	11.0	4.6	16	12.0	14.0	5.0	4.7	14.0	45.0
ST4N8x6-PT1/4-S	8x6	R1/4	22.9	22.0	22.9	44.9	31.0	12.0	4.6	16	12.0	14.0	7.0	4.7	15.0	46.0
ST4N10x6.5-PT1/4-S	10x6.5	R1/4	27.1	25.0	27.1	52.1	36.9	12.0	4.2	17	14.0	17.0	7.0	5.2	18.0	72.0
ST4N10x6.5-PT3/8-S	10x6.5	R3/8	27.1	26.0	27.1	53.1	36.9	13.0	4.2	17	14.0	17.0	9.0	5.2	18.0	70.0
ST4N10x8-PT1/4-S	10x8	R1/4	27.1	25.0	27.1	52.1	36.9	12.0	4.2	17	14.0	17.0	7.0	6.7	25.0	76.0
ST4N10x8-PT3/8-S	10x8	R3/8	27.1	26.0	27.1	53.1	36.9	13.0	4.2	17	14.0	17.0	9.0	6.7	25.0	113.0
ST4N12x8-PT3/8-S	12x8	R3/8	27.6	26.0	27.6	53.6	38.6	13.0	4.8	18	14.0	19.0	9.0	6.6	25.0	81.0
ST4N12x9-PT3/8-S	12x9	R3/8	27.6	26.0	27.6	53.6	38.6	13.0	4.8	18	14.0	19.0	9.0	7.6	33.0	130.0

●Inch size type (Group 1)

Product number	Applicable tubing outer diameter (inch)	T Thread size (R)	L1 (mm)	L2 (mm)	L6 (mm)	L7 (mm)	L8 (mm)	A (mm)	S (mm)	F Tubing insertion length (mm)	H1 Width across flat (mm)	H2 Width across flat (mm)	d1 (mm)	d2 Min. inner diameter (mm)	Effective sectional area (mm ²)	Weight (g)
ST1N1/4-PT1/8-S	1/4	R1/8	20.5	18.5	20.5	39.0	27.5	11.0	4.6	15	10.0	12.0	5.0	3.4	8.0	29.0

Tubing

Clean tubing

Processed tubing

PushOne fitting

QuickSeal fitting

Clean fitting/ Chemifit

Bamboo-shoot fitting

Control switch/ Detachable series

Jig/Tool/ Accessory

Technical information

Reference

QuickSeal Series Insertion Type (stainless)

Union connector

●Millimeter size type (Group 4)

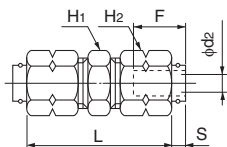

Product number	Applicable tubing outer diameter x inner diameter (mm)	L (mm)	S (mm)	F Tubing insertion length (mm)	H1 Width across flat (mm)	H2 Width across flat (mm)	d2 Min. inner diameter (mm)	Effective sectional area (mm ²)	Weight (g)
UC4N6x4-S	6x4	33.0	4.6	15	10.0	12.0	2.7	5.0	20.0
UC4N8x5-S	8x5	32.8	4.6	16	12.0	14.0	3.7	10.0	28.0
UC4N8x6-S	8x6	32.8	4.6	16	12.0	14.0	4.7	16.0	25.0
UC4N10x6.5-S	10x6.5	36.2	4.2	17	17.0	17.0	5.2	20.5	44.0
UC4N10x8-S	10x8	36.2	4.2	17	17.0	17.0	6.7	32.0	44.0
UC4N12x8-S	12x8	37.3	4.8	18	17.0	19.0	6.6	32.0	49.0
UC4N12x9-S	12x9	37.3	4.8	18	17.0	19.0	7.6	40.0	51.0

●Inch size type (Group 1)

Product number	Applicable tubing outer diameter (inch)	L (mm)	S (mm)	F Tubing insertion length (mm)	H1 Width across flat (mm)	H2 Width across flat (mm)	d2 Min. inner diameter (mm)	Effective sectional area (mm ²)	Weight (g)
UC1N1/4-S	1/4	33.1	4.6	15	10.0	12.0	3.4	8.5	20.0
UC1N5/16-S	5/16	32.7	4.6	16	12.0	14.0	4.7	16.0	25.0
UC1N3/8-S	3/8	35.4	4.6	17	14.0	17.0	5.7	22.5	40.0
UC1N1/2-S	1/2	37.6	4.6	18	17.0	19.0	8.2	45.0	47.0

90 degree union elbow

●Millimeter size type (Group 4)

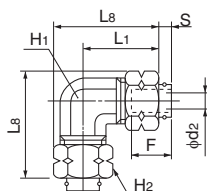

Product number	Applicable tubing outer diameter x inner diameter (mm)	L1 (mm)	Ls (mm)	S (mm)	F Tubing insertion length (mm)	H1 Width across flat (mm)	H2 Width across flat (mm)	d2 Min. inner diameter (mm)	Effective sectional area (mm ²)	Weight (g)
UL4N6x4-S	6x4	20.5	27.4	4.6	15	10.0	12.0	2.7	4.0	25.0
UL4N8x5-S	8x5	22.9	31.0	4.6	16	12.0	14.0	3.7	7.5	37.0
UL4N8x6-S	8x6	22.9	31.0	4.6	16	12.0	14.0	4.7	12.5	36.0
UL4N10x6.5-S	10x6.5	27.1	36.9	4.2	17	14.0	17.0	5.2	15.5	59.0
UL4N10x8-S	10x8	27.1	36.9	4.2	17	14.0	17.0	6.7	25.0	57.0
UL4N12x8-S	12x8	27.6	38.6	4.8	18	14.0	19.0	6.6	25.0	63.0
UL4N12x9-S	12x9	27.6	38.6	4.8	18	14.0	19.0	7.6	25.0	60.0

Union tee

●Millimeter size type (Group 4)

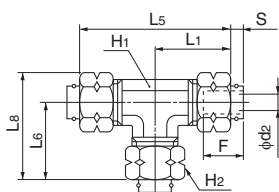

Product number	Applicable tubing outer diameter x inner diameter (mm)	L1 (mm)	L5 (mm)	L6 (mm)	L8 (mm)	S (mm)	F Tubing insertion length (mm)	H1 Width across flat (mm)	H2 Width across flat (mm)	d2 Min. inner diameter (mm)	Effective sectional area (mm ²)	Weight (g)
UT4N6x4-S	6x4	20.5	41.0	20.5	27.4	4.6	15	10.0	12.0	2.7	4.0	35.0
UT4N8x5-S	8x5	22.9	45.8	22.9	31.0	4.6	16	12.0	14.0	3.7	7.5	49.0
UT4N8x6-S	8x6	22.9	45.8	22.9	31.0	4.6	16	12.0	14.0	4.7	12.5	48.0
UT4N10x6.5-S	10x6.5	27.1	54.2	27.1	36.9	4.2	17	14.0	17.0	5.2	15.5	82.0
UT4N10x8-S	10x8	27.1	54.2	27.1	36.9	4.2	17	14.0	17.0	6.7	25.0	77.0
UT4N12x8-S	12x8	27.6	55.3	28.6	39.6	4.8	18	14.0	19.0	6.6	25.0	90.0
UT4N12x9-S	12x9	27.6	55.3	28.6	39.6	4.8	18	14.0	19.0	7.6	25.0	85.0

●Inch size type (Group 1)

Product number	Applicable tubing outer diameter (inch)	L1 (mm)	L5 (mm)	L6 (mm)	L8 (mm)	S (mm)	F Tubing insertion length (mm)	H1 Width across flat (mm)	H2 Width across flat (mm)	d2 Min. inner diameter (mm)	Effective sectional area (mm ²)	Weight (g)
UT1N1/4-S	1/4	20.5	41.1	20.5	27.5	4.6	15	10.0	12.0	3.4	6.5	34.0
UT1N5/16-S	5/16	22.8	45.7	22.8	30.9	4.6	16	12.0	14.0	4.7	12.5	49.0
UT1N3/8-S	3/8	23.7	47.4	23.7	33.5	4.6	17	12.0	17.0	5.7	18.5	64.0
UT1N1/2-S	1/2	27.8	55.6	27.8	38.8	4.6	18	14.0	19.0	8.2	30.0	84.0

*Made to order

Tubing

Clean tubing

Processed tubing

PushOne fitting

QuickSeal fitting

Clean fitting/ Chemifit

Bamboo-shoot fitting

Control switch/ Detachable series

Jig/Tool/ Accessory

Technical information

Reference

Stainless nut



●Millimeter size type (Group 4)

Product number	Applicable tubing outer diameter (mm)	T Thread size (M)	L (mm)	H ₂ Width across flat (mm)	Weight (g)
N6-S	6	M10×1.0	9.0	12.0	5.0
N8-S	8	M12×1.0	9.0	14.0	6.0
N10-S	10	M15×1.0	10.0	17.0	9.0
N12-S	12	M17×1.0	11.0	19.0	11.0

●Inch size type (Group 1)

Product number	Applicable tubing outer diameter (inch)	T Thread size (M)	L (mm)	H ₂ Width across flat (mm)	Weight (g)
N1/4-S	1/4	M10×1.0	9.0	12.0	5.0
N5/16-S	5/16	M12×1.0	9.0	14.0	6.0
N3/8-S	3/8	M14×1.0	10.0	17.0	10.0
N1/2-S	1/2	M17×1.0	11.5	19.0	11.0

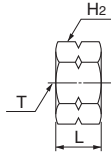

*The inch size type has no cut.

Nylon sleeve



●Millimeter size type (Color: milky white)

Product number	Applicable tubing outer diameter (mm)	L (mm)	Weight (g)
SN6	6	11.0	0.2
SN8	8	11.0	0.3
SN10	10	12.0	0.4
SN12	12	13.0	0.5

●Inch size type (Color: black)

Product number	Applicable tubing outer diameter (inch)	L (mm)	Weight (g)
SN1/4	1/4	11.0	0.2
SN5/16	5/16	11.0	0.3
SN3/8	3/8	12.0	0.4
SN1/2	1/2	13.0	0.5

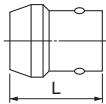

⚠ Caution: Nylon sleeves that have been used once cannot be reused.

Insertless Type

Screw-in type for general pneumatic piping

Features

- **Screw-in type**
Consisting of three parts: fitting body, nut and sleeve.
- **Large flow volume**
Large effective sectional area due to lack of an insertion part.
- **Only the connector is sealed**
Sealing tape is not required.



Cross-sectional structure diagram

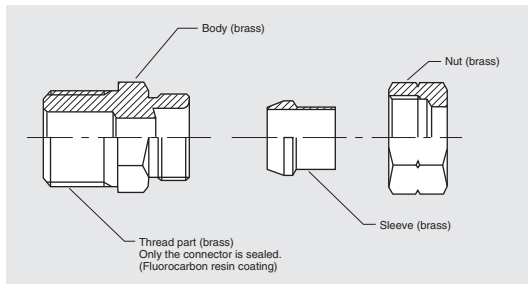

Product number example

4A01 - 2402

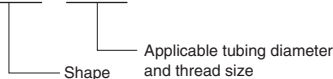

Applicable tubing

Nylon tubing



N2 N5 N1

Operating fluid, working temperature range

Operating fluid	Working temperature range
Air	-40°C~+100°C

See "Combination List of Tubing and Fitting" on page 8.

Pressure condition

Maximum working pressure: 1.0MPa
Negative pressure performance: -99.975kPa

Handling instructions

Caution: When the working conditions of tubes and fittings differ, use them under the lower specified conditions.

Caution: For use at a high temperature within the working temperature range, tighten the nut periodically. If the nut cannot be tightened further, cut the tubing end and insert the tubing again with a new sleeve.

Caution: Do not bend the pipe sharply near the tubing insertion port (sleeve end) of the fitting. Keep the tubing straight for twice as long as the tubing diameter from the insertion port.

See page 34 for the common handling instructions for fittings.

Reference

Instruction manual.....P.172
Effective sectional areaP.168
Negative-pressure performance list..P.169

QuickSeal Series Insertless type (brass)

Shape list



Connector

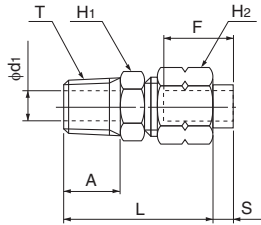

●Millimeter size type

Product number	Applicable tubing outer diameter (mm)	T Thread size (R)	L (mm)	A (mm)	S (mm)	F Tubing insertion length (mm)	H ₁ Width across flat (mm)	H ₂ Width across flat (mm)	d ₁ (mm)	Min. inner diameter (mm)	Effective sectional area (mm ²)	Weight (g)
4A01-2402	4	R1/8	27.9	11.0	2.7	14	10.0	10.0	5.0	2.0	3.0	13.0
4A01-2602	6	R1/8	27.9	11.0	2.6	14	10.0	12.0	5.0	4.0	10.0	15.0
4A01-2604	6	R1/4	29.9	12.0	2.6	14	14.0	12.0	7.0	4.0	10.0	23.0
4A01-2802	8	R1/8	27.8	11.0	2.6	15	12.0	14.0	5.0	5.0	18.0	17.0
4A01-2804	8	R1/4	29.8	12.0	2.6	15	14.0	14.0	7.0	6.0	25.0	24.0
4A01-3004	10	R1/4	31.0	12.0	2.3	18	17.0	17.0	7.5	7.5	39.0	31.0
4A01-3006	10	R3/8	32.0	13.0	2.3	18	17.0	17.0	9.0	7.5	39.0	38.0
4A01-3206	12	R3/8	32.5	13.0	3.1	19	17.0	19.0	9.0	8.0	45.0	40.0
4A01-3208	12	R1/2	40.5	18.0	3.1	19	24.0	19.0	12.0	8.0	45.0	71.0

☞ Only the connector is sealed.

90 degree elbow

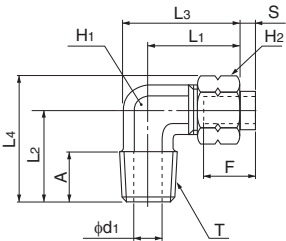

●Millimeter size type

Product number	Applicable tubing outer diameter (mm)	T Thread size (R)	L ₁ (mm)	L ₂ (mm)	L ₃ (mm)	L ₄ (mm)	A (mm)	S (mm)	F Tubing insertion length (mm)	H ₁ Width across flat (mm)	H ₂ Width across flat (mm)	d ₁ (mm)	Min. inner diameter (mm)	Effective sectional area (mm ²)	Weight (g)
4A02-2402	4	R1/8	20.4	18.5	26.2	24.3	11.0	2.7	14	10.0	10.0	5.0	2.0	3.0	19.0
4A02-2602	6	R1/8	20.4	18.5	26.2	25.4	11.0	2.6	14	10.0	12.0	5.0	4.0	9.0	20.0
4A02-2604	6	R1/4	22.9	22.0	29.9	28.9	12.0	2.6	14	12.0	12.0	7.0	4.0	10.0	30.0
4A02-2802	8	R1/8	22.8	21.0	29.8	29.1	11.0	2.6	15	12.0	14.0	5.0	5.0	16.0	29.0
4A02-2804	8	R1/4	22.8	22.0	29.8	30.1	12.0	2.6	15	12.0	14.0	7.0	6.0	22.0	32.0
4A02-3004	10	R1/4	27.0	25.0	35.1	34.8	13.5	2.3	18	14.0	17.0	7.0	7.0	30.0	46.0
4A02-3006	10	R3/8	27.0	26.0	35.5	35.8	13.0	2.3	18	14.0	17.0	9.0	7.5	35.0	82.0
4A02-3206	12	R3/8	27.5	26.0	36.0	37.0	13.0	3.1	19	14.0	19.0	9.0	8.0	40.0	53.0
4A02-3208	12	R1/2	30.0	33.0	40.8	44.0	18.0	3.1	19	14.0	19.0	10.0	8.0	40.0	90.0

Tee

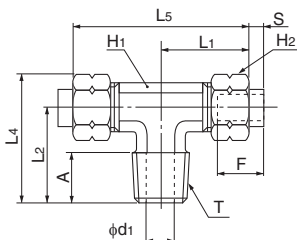

●Millimeter size type

Product number	Applicable tubing outer diameter (mm)	T Thread size (R)	L ₁ (mm)	L ₂ (mm)	L ₄ (mm)	L ₅ (mm)	A (mm)	S (mm)	F Tubing insertion length (mm)	H ₁ Width across flat (mm)	H ₂ Width across flat (mm)	d ₁ (mm)	Min. inner diameter (mm)	Effective sectional area (mm ²)	Weight (g)
4A03-2402	4	R1/8	20.4	18.5	24.3	40.8	11.0	2.7	14	10.0	10.0	5.0	2.0	3.0	27.0
4A03-2602	6	R1/8	20.4	18.5	25.4	40.8	11.0	2.6	14	10.0	12.0	5.0	4.0	9.0	29.0
4A03-2604	6	R1/4	22.9	22.0	28.9	45.8	12.0	2.6	14	12.0	12.0	7.0	4.0	10.0	43.0
4A03-2802	8	R1/8	22.8	21.0	29.1	45.7	11.0	2.6	15	12.0	14.0	5.0	5.0	16.0	42.0
4A03-2804	8	R1/4	22.8	22.0	30.1	45.7	12.0	2.6	15	12.0	14.0	7.0	6.0	22.0	43.0
4A03-3004	10	R1/4	27.0	25.0	34.8	53.9	12.0	2.3	18	14.0	17.0	7.0	7.0	30.0	69.0
4A03-3006	10	R3/8	27.0	26.0	35.8	53.9	13.0	2.3	18	14.0	17.0	9.0	7.5	35.0	73.0
4A03-3206	12	R3/8	27.5	26.0	37.0	54.9	13.0	3.1	19	14.0	19.0	9.0	8.0	40.0	79.0
4A03-3208	12	R1/2	30.5	33.0	44.0	60.9	18.0	3.1	19	18.0	19.0	12.0	8.0	40.0	125.0

Tubing

Clean tubing

Processed tubing

PushOne fitting

QuickSeal fitting

Clean fitting/Chemifit

Bamboo-shoot fitting

Control switch/Detachable series

Jig/Tool/Accessory

Technical information

Reference

Service tee

●Millimeter size type

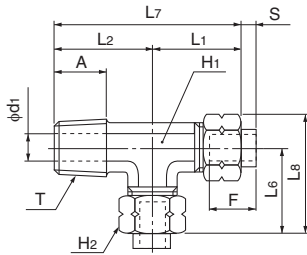

Product number	Applicable tubing outer diameter (mm)	T Thread size (R)	L ₁ (mm)	L ₂ (mm)	L ₆ (mm)	L ₇ (mm)	L ₈ (mm)	A (mm)	S (mm)	F Tubing insertion length (mm)	H ₁ Width across flat (mm)	H ₂ Width across flat (mm)	d ₁ (mm)	Min. inner diameter (mm)	Effective sectional area (mm ²)	Weight (g)
* 4A04-2402	4	R1/8	20.4	18.5	20.4	38.9	26.2	11.0	2.7	14	10.0	10.0	5.0	2.0	3.0	27.0
4A04-2602	6	R1/8	20.4	18.5	20.4	38.9	27.4	11.0	2.6	14	10.0	12.0	5.0	4.0	9.0	29.0
4A04-2604	6	R1/4	22.9	22.0	22.9	44.9	29.9	12.0	2.6	14	12.0	12.0	7.0	4.0	10.0	37.0
4A04-2802	8	R1/8	22.8	21.0	22.8	43.8	30.9	12.0	2.6	15	12.0	14.0	5.0	5.0	16.0	41.0
4A04-2804	8	R1/4	22.8	22.0	22.8	44.8	30.9	12.0	2.6	15	12.0	14.0	7.0	6.0	22.0	43.0
* 4A04-3004	10	R1/4	27.0	25.0	27.0	52.0	36.8	12.0	2.3	18	14.0	17.0	7.0	7.0	30.0	70.0
4A04-3006	10	R3/8	27.0	26.0	27.0	53.0	36.8	13.0	2.3	18	14.0	17.0	9.0	7.5	35.0	73.0
* 4A04-3206	12	R3/8	27.5	26.0	27.5	53.5	38.4	13.0	3.1	19	14.0	19.0	9.0	8.0	40.0	80.0
* 4A04-3208	12	R1/2	30.5	35.5	30.5	66.0	41.4	18.0	3.1	19	18.0	19.0	12.0	8.0	40.0	127.0

*Made to order

Union tee

●Millimeter size type

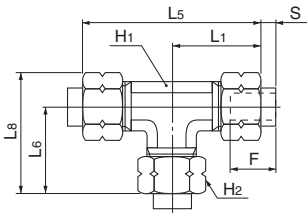

Product number	Applicable tubing outer diameter (mm)	L ₁ (mm)	L ₅ (mm)	L ₆ (mm)	L ₈ (mm)	S (mm)	F Tubing insertion length (mm)	H ₁ Width across flat (mm)	H ₂ Width across flat (mm)	Min. inner diameter (mm)	Effective sectional area (mm ²)	Weight (g)
4A05-2400	4	20.4	40.8	20.4	26.2	2.7	14	10.0	10.0	2.0	3.0	30.0
4A05-2600	6	20.4	40.8	20.4	27.4	2.6	14	10.0	12.0	4.0	8.0	34.0
4A05-2800	8	22.8	45.7	22.8	30.9	2.6	15	12.0	14.0	6.0	20.0	45.0
4A05-3000	10	27.0	53.9	27.0	36.8	2.3	18	14.0	17.0	7.5	31.0	74.0
4A05-3200	12	27.5	54.9	27.5	38.4	3.1	19	14.0	19.0	8.0	37.0	85.0

Swivel nut internal connector

●Millimeter size type

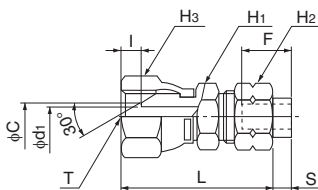

Product number	Applicable tubing outer diameter (mm)	T Thread size (G)	L (mm)	S (mm)	I (mm)	F Tubing insertion length (mm)	H ₁ Width across flat (mm)	H ₂ Width across flat (mm)	H ₃ Width across flat (mm)	C (mm)	d ₁ (mm)	Min. inner diameter (mm)	Effective sectional area (mm ²)	Weight (g)
* 4A06-2402	4	G1/8	32.9	2.7	4.0	14	12.0	10.0	14.0	5.0	3.0	3.0	3.5	24.0
* 4A06-2602	6	G1/8	32.9	2.6	4.0	14	12.0	12.0	14.0	5.0	3.0	3.0	6.5	25.0
4A06-2604	6	G1/4	34.6	2.6	5.7	14	17.0	12.0	19.0	7.0	5.0	5.0	10.0	43.0
4A06-2804	8	G1/4	34.5	2.6	5.7	15	17.0	14.0	19.0	7.0	5.0	5.0	18.0	45.0
* 4A06-3006	10	G3/8	40.8	2.3	6.8	18	19.0	17.0	22.0	10.0	8.0	8.0	42.0	75.0
* 4A06-3206	12	G3/8	41.3	3.1	6.8	19	19.0	19.0	22.0	10.0	8.0	8.0	45.0	67.0
* 4A06-3208	12	G1/2	51.0	3.1	9.5	19	22.0	19.0	27.0	14.0	10.0	10.0	54.0	115.0

*Made to order

Tubing
Clean tubing
Processed tubing
PushOne fitting
QuickSeal fitting
Clean fitting/Chemifit
Bamboo-shoot fitting
Control switch/Detachable series
Jig/Tool/Accessory
Technical information
Reference

Union connector

●Millimeter size type



Product number	Applicable tubing outer diameter (mm)	L (mm)	S (mm)	F Tubing insertion length (mm)	H ₁ Width across flat (mm)	H ₂ Width across flat (mm)	Min. inner diameter (mm)	Effective sectional area (mm ²)	Weight (g)
4A07-2400	4	32.8	2.7	14	8.0	10.0	2.0	3.0	15.0
4A07-2600	6	32.8	2.6	14	10.0	12.0	4.0	10.0	20.0
4A07-2800	8	32.7	2.6	15	14.0	14.0	6.0	25.0	27.0
4A07-3000	10	35.9	2.3	18	17.0	17.0	7.5	39.0	42.0
4A07-3200	12	36.9	3.1	19	17.0	19.0	8.0	45.0	48.0

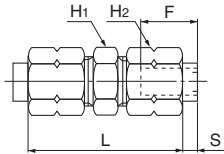

90 degree union elbow

●Millimeter size type



Product number	Applicable tubing outer diameter (mm)	L ₁ (mm)	L ₂ (mm)	S (mm)	F Tubing insertion length (mm)	H ₁ Width across flat (mm)	H ₂ Width across flat (mm)	Min. inner diameter (mm)	Effective sectional area (mm ²)	Weight (g)
4A08-2400	4	20.4	26.2	2.7	14	10.0	10.0	2.0	2.0	22.0
4A08-2600	6	20.4	27.4	2.6	14	10.0	12.0	4.0	8.0	25.0
4A08-2800	8	22.8	30.9	2.6	15	12.0	14.0	6.0	20.0	33.0
4A08-3000	10	27.0	36.8	2.3	18	14.0	17.0	7.5	31.0	52.0
4A08-3200	12	27.5	38.4	3.1	19	14.0	19.0	8.0	37.0	59.0

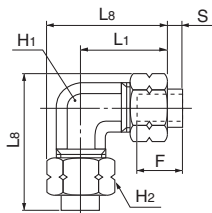

Brass nut

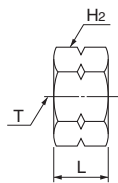

●Millimeter size type

Product number	Applicable tubing outer diameter (mm)	T Thread size (M)	L (mm)	H ₂ Width across flat (mm)	Weight (g)
N4	4	M8×0.75	9.0	10.0	4.0
N6	6	M10×1.0	9.0	12.0	5.0
N8	8	M12×1.0	9.0	14.0	6.0
N10	10	M15×1.0	10.0	17.0	9.0
N12	12	M17×1.0	11.0	19.0	11.0

Brass sleeve

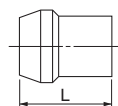

●Millimeter size type

Product number	Applicable tubing outer diameter (mm)	L (mm)	Weight (g)
MSN4	4	9.0	0.7
MSN6	6	9.0	1.0
MSN8	8	9.0	1.3
MSN10	10	10.0	2.1
MSN12	12	11.3	2.8

☞ Insertless type requires a brass sleeve.

⚠ Caution: Brass sleeves that have been used once cannot be reused.

Tubing

Clean tubing

Processed tubing

PushOne fitting

QuickSeal fitting

Clean fitting/Chemifit

Bamboo-shoot fitting

Control switch/Detachable series

Jig/Tool/Accessory

Technical information

Reference

DK Tubing Dedicated Type

Screw-in type fitting dedicated for DK tubing

Features

- **Screw-in type**
Consisting of three parts: fitting body, nut and sleeve. Special fittings for DK tubes.
- **Only the connector is sealed**
Sealing tape is not required.



Cross-sectional structure diagram

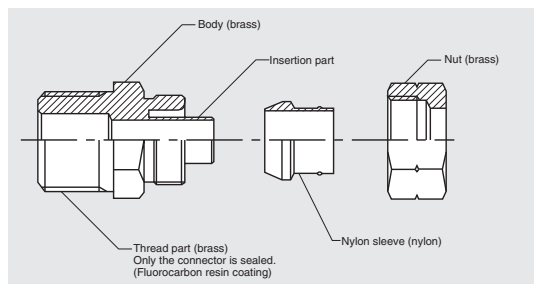

Operating fluid, working temperature range

Operating fluid	Working temperature range
Air	-40°C~+60°C

Pressure condition

Maximum working pressure: 1.0MPa
Negative pressure performance: -101.294kPa

Handling instructions

- ⚠ **Caution:** This is dedicated for DK tubing. Cannot be connected to other tubes.
- ⚠ **Caution:** For use at a high temperature within the working temperature range, tighten the nut periodically. If the nut cannot be tightened further, cut the tubing end and insert the tubing again with a new sleeve.
- ⚠ **Caution:** Do not bend the pipe sharply near the tubing insertion port (sleeve end) of the fitting. Keep the tubing straight for twice as long as the tubing diameter from the insertion port.

📖 See page 34 for the common handling instructions for fittings.

Reference

Instruction manual.....P.172
 Effective sectional areaP.168

Product number example

DC 6 - PT1/8



Applicable tubing

Shape-keeping DK tubing



DK Tubing Dedicated Type

Shape list

<p>Connector DC</p>	<p>90 degree elbow DL</p>	<p>Tee DT</p>	<p>Union connector UDC</p>	<p>Union tee UDT</p>
<p>Panel touch connector DUT (Nickel plated)</p>	<p>Panel touch connector for copper pipe DUP (Nickel plated)</p>	<p>Brass nut N</p>	<p>Nylon sleeve SN</p>	

Connector



Product number	Applicable DK tubing size (mm)	T Thread size (R)	L (mm)	A (mm)	F Tubing insertion length (mm)	H ₁ Width across flat (mm)	H ₂ Width across flat (mm)	S (mm)	d ₁ (mm)	d ₂ (mm)	Effective sectional area (mm ²)	Weight (g)
DC6-PT1/8	6	R1/8	28.0	11.0	15	10.0	12.0	4.6	5.0	2.8	6.0	14.5
DC6-PT1/4	6	R1/4	30.0	12.0	15	14.0	12.0	4.6	7.0	2.8	6.0	22.0
DC10-PT1/8	10	R1/8	30.1	11.0	17	17.0	17.0	4.2	5.0	5.7	18.0	28.0
DC10-PT1/4	10	R1/4	31.1	12.0	17	17.0	17.0	4.2	7.0	5.7	23.0	32.0
DC10-PT3/8	10	R3/8	32.1	13.0	17	17.0	17.0	4.2	9.0	5.7	23.0	38.0

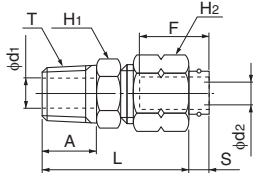

90 degree elbow



Product number	Applicable DK tubing size (mm)	T Thread size (R)	L ₁ (mm)	L ₂ (mm)	L ₃ (mm)	L ₄ (mm)	A (mm)	F Tubing insertion length (mm)	H ₁ Width across flat (mm)	H ₂ Width across flat (mm)	S (mm)	d ₁ (mm)	d ₂ (mm)	Effective sectional area (mm ²)	Weight (g)
DL6-PT1/8	6	R1/8	20.5	18.5	26.2	25.4	11.0	15	10.0	12.0	4.6	5.0	2.8	5.0	21.0
DL6-PT1/4	6	R1/4	23.0	22.0	29.9	28.9	12.0	15	12.0	12.0	4.6	7.0	2.8	5.0	31.0
DL10-PT1/8	10	R1/8	27.1	22.0	35.2	31.8	11.0	17	14.0	17.0	4.2	5.0	5.7	16.0	42.0
DL10-PT1/4	10	R1/4	27.1	25.0	35.2	34.8	13.5	17	14.0	17.0	4.2	7.0	5.7	22.0	50.0
DL10-PT3/8	10	R3/8	27.1	26.0	35.7	35.8	13.0	17	14.0	17.0	4.2	9.0	5.7	22.0	53.0

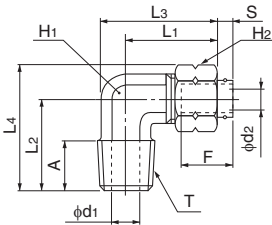

Tee



Product number	Applicable DK tubing size (mm)	T Thread size (R)	L ₁ (mm)	L ₂ (mm)	L ₄ (mm)	L ₅ (mm)	A (mm)	F Tubing insertion length (mm)	H ₁ Width across flat (mm)	H ₂ Width across flat (mm)	S (mm)	d ₁ (mm)	d ₂ (mm)	Effective sectional area (mm ²)	Weight (g)
DT6-PT1/8	6	R1/8	20.5	18.5	25.4	40.9	11.0	15	10.0	12.0	4.6	5.0	2.8	5.0	30.0
DT6-PT1/4	6	R1/4	23.0	22.0	28.9	45.9	12.0	15	12.0	12.0	4.6	7.0	2.8	5.0	43.0
DT10-PT1/4	10	R1/4	27.1	25.0	34.8	54.2	12.0	17	14.0	17.0	4.2	7.0	5.7	22.0	71.0
DT10-PT3/8	10	R3/8	27.1	26.0	35.8	54.2	13.0	17	14.0	17.0	4.2	9.0	5.7	22.0	71.0

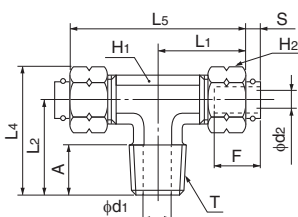

Tubing

Clean tubing

Processed tubing

PushOne fitting

QuickSeal fitting

Clean fitting/Chemifit

Bamboo-shoot fitting

Control switch/Detachable series

Jig/Tool/Accessory

Technical information

Reference

Union connector



Product number	Applicable DK tubing size (mm)	L (mm)	F Tubing insertion length (mm)	H ₁ Width across flat (mm)	H ₂ Width across flat (mm)	S (mm)	d ₂ (mm)	Effective sectional area (mm ²)	Weight (g)
UDC6	6	32.9	15	10.0	12.0	4.6	2.8	6.0	20.0
UDC10	10	36.2	17	15.0	17.0	4.2	5.7	23.0	39.0

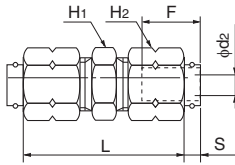

Union tee



Product number	Applicable DK tubing size (mm)	L ₁ (mm)	L ₅ (mm)	L ₆ (mm)	L ₈ (mm)	F Tubing insertion length (mm)	H ₁ Width across flat (mm)	H ₂ Width across flat (mm)	S (mm)	d ₂ (mm)	Effective sectional area (mm ²)	Weight (g)
UDT6	6	20.5	40.9	20.5	27.4	15	10.0	12.0	4.6	2.8	4.0	35.0
UDT10	10	27.1	54.2	27.1	36.9	17	14.0	17.0	4.2	5.7	18.5	81.5

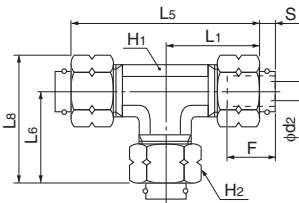

Panel touch connector (nickel plated)



Product number	Applicable DK tubing size (mm)	L (mm)	F Tubing insertion length (mm)	t Max. panel thickness (mm)	H ₂ Width across flat (mm)	H ₄ Width across flat (mm)	S (mm)	d ₂ (mm)	T ₂ Recommended panel hole diameter (mm)	Washer outer diameter (mm)	Washer thickness (mm)	Effective sectional area (mm ²)	Weight (g)
DUT6	6	44.9	15	10	12.0	17.0	4.6	2.8	11	18	2.0	5.5	45.0
DUT10	10	51.2	17	7.1	17.0	24.0	4.2	5.7	16	28	3.0	21.5	104.0

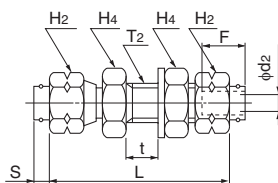

Tubing

Clean tubing

Processed tubing

PushOne fitting

QuickSeal fitting

Clean fitting/ Chemifit

Bamboo-shoot fitting

Control switch/ Detachable series

Jig/Tool/ Accessory

Technical information

Reference

Panel touch connector for copper pipe (nickel plated)



Product number	Applicable DK tubing size (mm)	Applicable copper pipe (mm)	L (mm)	F Tubing insertion length (mm)	t Max. panel thickness (mm)	H ₂ Width across flat (mm)	H ₄ Width across flat (mm)	H ₅ Width across flat (mm)	S (mm)	d ₂ (mm)	T ₂ Recommended panel hole diameter (mm)	Washer outer diameter (mm)	Washer thickness (mm)	Effective sectional area (mm ²)	Weight (g)
DUP6	6	6.0	51.0	15	10.0	12.0	17.0	14.0	4.6	2.8	11	18	2.0	5.5	49.0
DUP10	10	10.0	61.8	17	7.1	17.0	24.0	17.0	4.2	5.7	16	28	3.0	21.5	133.0

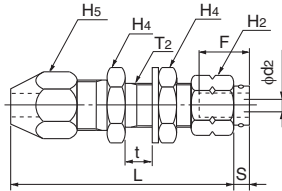

*Fitting part for connecting DK tubing and copper pipe by panel touch method.

Brass nut



Product number	Applicable DK tubing size (mm)	T Thread size (mm)	L (mm)	H ₂ (mm)	Weight (g)
N6	6	M10x1	9.0	12.0	5.0
N10	10	M15x1	10.0	17.0	9.0

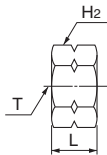

Nylon sleeve



Product number	Applicable DK tubing size (mm)	L (mm)	Weight (g)
SN6	6	11.0	0.2
SN10	10	12.0	0.4

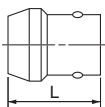

⚠ Caution: Nylon sleeves that have been used once cannot be reused.

Tubing

Clean tubing

Processed tubing

PushOne fitting

QuickSeal fitting

Clean fitting/Chemifit

Bamboo-shoot fitting

Control switch/Detachable series

Jig/Tool/Accessory

Technical information

Reference

QuickSeal Series

Nylon Coil Tubing Dedicated Type

Screw-in type fitting dedicated for nylon coil tubing

Features

- **Screw-in type**
Dedicated use for nylon coil tubing. Consisting of three parts: fitting body, nut and sleeve.



Product number example

S1/4 - M1/4

Thread size
Product number of applicable nylon coil tubing

Applicable tubing

Nylon Coil Tubing



Reference

Instruction manualP.172
Effective sectional areaP.168

Operating fluid, working temperature range

Operating fluid	Working temperature range
Air	-40°C~+100°C

Pressure condition

Maximum working pressure: 1.2MPa
Negative pressure performance:
-101.294kPa

Handling instructions

- ⚠ **Caution:** Dedicated for nylon coil tubing. Cannot be used for connecting other types of tubing.
- ⚠ **Caution:** For use at a high temperature within the working temperature range, tighten the nut periodically. If the nut cannot be tightened further, cut the tubing end and insert the tubing again with a new sleeve.

👉 See page 34 for the common handling instructions for fittings.

Connector



Product number	Applicable nylon coil tubing outer diameter	T Thread size (R)	L (mm)	A (mm)	F Tubing insertion length (mm)	H ₁ Width across flat (mm)	H ₂ Width across flat (mm)	d ₁ (mm)	D ₂ (mm)	Min. inner diameter (mm)	Effective sectional area (mm ²)	Weight (g)
S3/16-M1/8	S3/16	R1/8	115.2	11.0	16	10.0	12.0	5.0	8.5	3.4	8.5	24.0
S1/4-M1/8	S1/4	R1/8	114.3	9.0	18	12.0	14.0	5.4	11.2	5.4	22.0	31.0
S1/4-M1/4	S1/4	R1/4	118.3	12.0	18	14.0	14.0	7.0	11.2	5.4	22.0	36.0
S3/8-M3/8	S3/8	R3/8	120.2	13.0	22	17.0	22.0	9.0	15.6	8.2	50.0	72.0
S1/2-M3/8	S1/2	R3/8	178.5	13.0	29	24.0	27.0	10.2	19.8	10.2	78.0	139.0
S1/2-M1/2	S1/2	R1/2	182.5	17.0	29	24.0	27.0	12.0	19.8	10.2	80.0	160.0
S3/4-M3/4	S3/4	R3/4	—	19.0	31	32.0	35.0	18.0	—	18.0	231.0	—

👉 S3/4 has no spring.

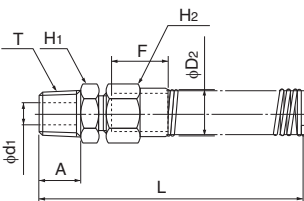

ES swivel nut internal connector



Product number	Applicable nylon coil tubing outer diameter	T Thread size (G)	L (mm)	I (mm)	F Tubing insertion length (mm)	H ₁ Width across flat (mm)	H ₂ Width across flat (mm)	H ₃ Width across flat (mm)	C (mm)	d ₁ (mm)	D ₂ (mm)	Effective sectional area (mm ²)	Weight (g)
S1/4-ES1/4	S1/4	G1/4	123.3	8.5	18	14.0	14.0	19.0	9.0	5.0	11.2	18.5	53.0
S3/8-ES3/8	S3/8	G3/8	129.0	10.0	22	19.0	22.0	22.0	13.0	8.0	15.6	46.5	97.0
S1/2-ES1/2	S1/2	G1/2	189.0	13.0	29	24.0	27.0	27.0	16.0	10.2	19.8	80.0	186.0

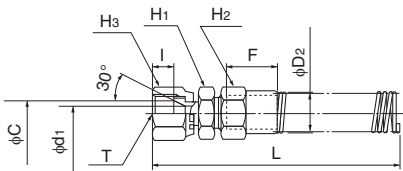

FS swivel nut internal connector



Product number	Applicable nylon coil tubing outer diameter	T Thread size (G)	L (mm)	I (mm)	F Tubing insertion length (mm)	H ₁ Width across flat (mm)	H ₂ Width across flat (mm)	H ₃ Width across flat (mm)	C (mm)	d ₁ (mm)	D ₂ (mm)	Effective sectional area (mm ²)	Weight (g)
S1/4-FS1/4	S1/4	G1/4	123.3	5.7	18	14.0	14.0	19.0	7.0	5.0	11.2	18.5	55.0
S3/8-FS3/8	S3/8	G3/8	129.0	6.8	22	19.0	22.0	22.0	10.0	8.0	15.6	46.5	102.0
S1/2-FS1/2	S1/2	G1/2	189.0	9.5	29	24.0	27.0	27.0	14.0	10.2	19.8	80.0	193.0

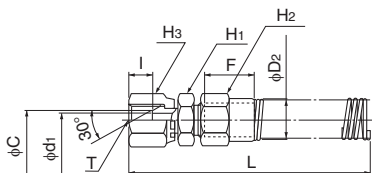

Nylon sleeve (dedicated for nylon coil tubing)

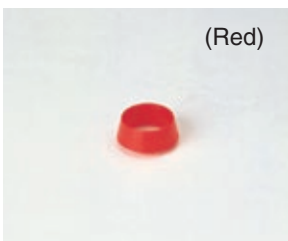

(Red)

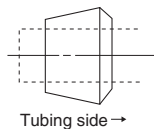

Caution
Pay attention to the directions when attaching the sleeve.

Product number	Applicable nylon coil tubing outer diameter
SS3/16	S3/16
SS1/4	S1/4
SS3/8	S3/8
SS1/2	S1/2

Caution: Nylon sleeves that have been used once cannot be reused.

Brass sleeve (dedicated for nylon coil tubing)



Product number	Applicable nylon coil tubing outer diameter
S1/4	S1/4

Caution: Nylon sleeves that have been used once cannot be reused.

Insertion part for S3/4



Product number	Applicable nylon coil tubing outer diameter
S1/4	S1/4

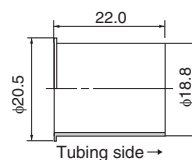

Tubing

Clean tubing

Processed tubing

PushOne fitting

QuickSeal fitting

Clean fitting/Chemifit

Bamboo-shoot fitting

Control switch/Detachable series

Jig/Tool/Accessory

Technical information

Reference

Chemifit™ C1 Series

PushOne™ fitting for clean air, pure water and chemical liquids

Features

- **Made in oil-free process**
Assembled after cleaning each part in a clean room. No oil or fat is used in the sealing materials.
- **PushOne connection of tubing**
The tubes can be connected without using a jig or tools.
- **Nonmetal liquid-contact surface**
No contact of liquid and metal, preventing the metal ions from dissolving.
- **High performance, free of dust and contamination**
Made of special polypropylene resin.
- **Highly smooth inner surface**
Smooth inner surface due to ejection forming.
- **Double clean package**
Each fitting is packed in a clean room and put in a zipper sealed bag.
- **Easy directional setting of tubing**
The body can rotate freely even after tightening up the thread part. Good for piping of Elbow and Tee.
- **Compliant with the MHLW Ministerial Notification No.201(2006), MHW Ministerial Notification No.370(1959), Japan**

Cross-sectional structure diagram

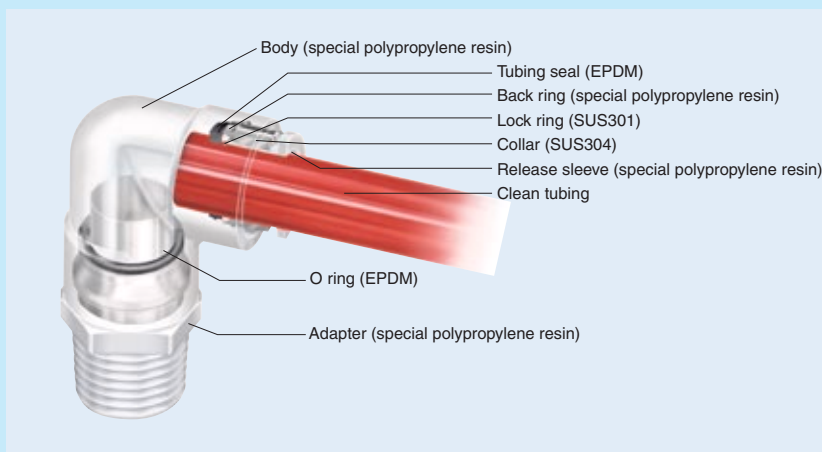

Product number example

EL 6 - R1/8 - C1

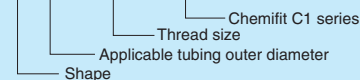

Distinction of millimeter/inch sizes

- The tubing size is shown on the release sleeve.



Operating fluid, working temperature range

Operating fluid	Working temperature range
Air (clean air)	-20°C~+80°C
Water (pure water)	0°C~+80°C

☞ Contact us for various chemical liquids.

☞ See "Combination List of Tubing and Fitting" on page 8.

Pressure condition

Maximum working pressure: 0.7MPa(at20°C)
Negative pressure performance: -99.975kPa

Relation between the working temperature and the maximum working pressure

The maximum working pressure varies with the working temperature (environmental temperature). For use at an abnormal temperature, always check the maximum working pressure change in the graph below and keep the pressure within the range.

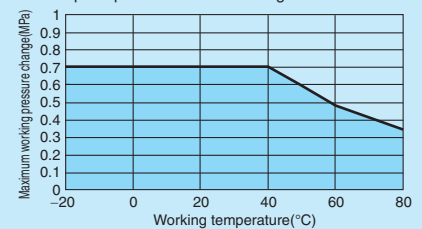

Handling instructions

- ⚠ **Caution:** When the working conditions of tubes and fittings differ, use them under the lower specified conditions.
- ⚠ **Caution:** Stress relaxation occurs more readily with resin thread than with metal thread. The relaxation is prominent at a high temperature. Tighten the thread periodically.
- ⚠ **Caution:** When water is used as the operating fluid, confirm that there is no water leakage damage to equipment and instruments due to construction failure.
- ⚠ **Caution:** When water is used as the operating fluid, do not allow it to freeze.
- ⚠ **Caution:** Do not bend the pipe sharply near the tubing insertion port (sleeve end) of the fitting. Keep the tubing straight for twice as long as the tubing diameter from the insertion port.

☞ See page 34 for the common handling instructions for fittings.

Applicable tubing

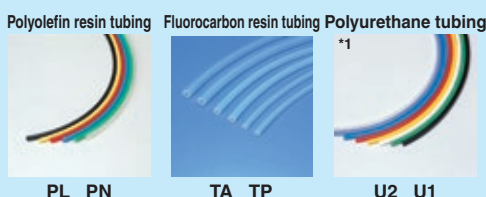

Related products and product introduction



Reference

Instruction manualP.174
Chemical resistance specification tableP.198
Effective sectional area ..P.168
Negative-pressure performance listP.169

(*1) Combinatory use of U2 or U1 tubing and Chemifit C1 series mixes general and clean type performances. When using them together in a clean environment, be aware of how this could lower the cleanliness level.

Chemifit™ C1 Series

Shape list



Tubing

Clean tubing

Processed tubing

PushOne fitting

QuickSeal fitting

Clean fitting/
Chemifit

Bamboo-shoot fitting

Control switch/
Detachable series

Jig/Tool/
Accessory

Technical information

Reference

Oil-free processing, Clean wrapping and packaging

● Ultrasonic cleaning with no oil or fat used for assembling in a clean room.

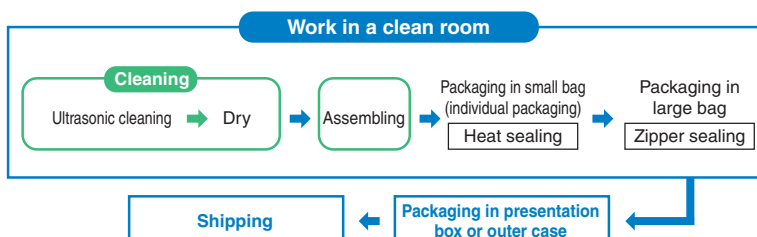

● High-barrier sheet packaging available

What is high-barrier sheet packaging?

In order to maintain the cleanliness of our products, no space for oxygen, water, or corrosive gas is allowed inside the package so a packaging bag with a high gas barrier is needed for protecting the content from these gases. To meet this requirement, Nitta provides high-barrier bags with a high gas barrier performance also for nitrogen sealing or atmospheric sealing.



- The packaging bags that Nitta uses have the highest gas barrier performance among clear bags.
- The bags do not contain halogen, etc., for safe burning.

Connector

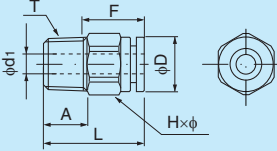

●Millimeter size type

Product number	Applicable tubing outer diameter (mm)	T Thread size (R)	L (mm)	A (mm)	F Tubing insertion length (mm)	H×φ Width across flat (mm)	D (mm)	d ₁ (mm)	Effective sectional area (mm ²)	Weight (g)
EC4-R1/8-C1	4	R1/8	21.9	9.0	14	12.0×13.0	10.0	2.5	4.0	2.0
EC4-R1/4-C1	4	R1/4	24.9	12.0	14	14.0×15.4	10.0	2.5	4.0	2.0
EC6-R1/8-C1	6	R1/8	23.6	9.0	15	14.0×15.4	13.0	4.0	10.5	2.0
EC6-R1/4-C1	6	R1/4	26.6	12.0	15	14.0×15.4	13.0	4.0	10.5	3.0
EC8-R1/8-C1	8	R1/8	28.6	9.0	16	17.0×18.5	15.0	6.0	20.0	4.0
EC8-R1/4-C1	8	R1/4	27.6	12.0	16	17.0×18.5	15.0	6.0	25.0	4.0
EC10-R1/4-C1	10	R1/4	33.2	12.0	19	19.0×21.0	18.0	8.0	40.0	7.0
EC10-R3/8-C1	10	R3/8	32.4	14.0	19	19.0×21.0	18.0	8.0	40.0	7.0
EC10-R1/2-C1	10	R1/2	35.4	16.0	19	22.0×24.5	18.0	10.0	—	—
EC12-R3/8-C1	12	R3/8	33.4	14.0	20	22.0×24.5	21.0	10.0	50.0	9.0
EC12-R1/2-C1	12	R1/2	35.4	16.0	20	22.0×24.5	21.0	10.0	50.0	11.0

EC6-N1/8-C1	6	NPT1/8	23.6	9.0	15	14.0×15.4	13.0	4.0	10.5	2.0
EC6-N1/4-C1	6	NPT1/4	26.6	12.0	15	14.0×15.4	13.0	4.0	10.5	3.0
EC10-N1/4-C1	10	NPT1/4	33.2	12.0	19	19.0×21.0	18.0	8.0	40.0	7.0

●Inch size type

Product number	Applicable tubing outer diameter (inch)	T Thread size (R)	L (mm)	A (mm)	F Tubing insertion length (mm)	H×φ Width across flat (mm)	D (mm)	d ₁ (mm)	Effective sectional area (mm ²)	Weight (g)
EC1/4-R1/8-C1	1/4	R1/8	24.6	9.0	16	14.0×15.4	13.0	4.0	12.0	2.0
EC1/4-R1/4-C1	1/4	R1/4	27.6	12.0	16	14.0×15.4	13.0	4.0	12.0	3.0
EC3/8-R1/4-C1	3/8	R1/4	34.0	12.0	20	19.0×21.0	18.0	8.0	35.0	7.0
EC3/8-R3/8-C1	3/8	R3/8	33.2	14.0	20	19.0×21.0	18.0	8.0	35.0	7.0
EC1/2-R3/8-C1	1/2	R3/8	35.4	14.0	23	22.0×24.5	21.5	10.0	66.5	9.0
EC1/2-R1/2-C1	1/2	R1/2	37.4	16.0	23	22.0×24.5	21.5	10.0	66.5	10.0

Through connector  A tubing can be inserted completely through the connector.

●Millimeter size type

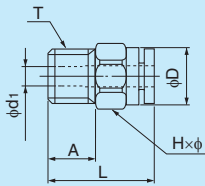

Product number	Applicable tubing outer diameter (mm)	T Thread size (R)	L (mm)	A (mm)	H×φ Width across flat (mm)	D (mm)	d ₁ (mm)	Weight (g)
ETC4-R1/8-C1	4	R1/8	21.9	9.0	12.0×13.0	10.0	4.2	2.0
ETC4-R1/4-C1	4	R1/4	24.9	12.0	14.0×15.4	10.0	4.2	2.0
ETC6-R1/4-C1	6	R1/4	26.6	12.0	14.0×15.4	13.0	6.5	3.0
ETC8-R1/4-C1	8	R1/4	27.6	12.0	17.0×18.5	15.0	8.2	4.0
ETC10-R3/8-C1	10	R3/8	32.4	14.0	19.0×21.0	18.0	10.2	7.0
ETC12-R1/2-C1	12	R1/2	35.4	16.0	22.0×24.5	21.0	12.3	10.0

Tubing
Clean tubing
Processed tubing
PushOne fitting
QuickSeal fitting
Clean fitting/ Chemifit
Bamboo-shoot fitting
Control switch/ Detachable series
Jig/Tool/ Accessory
Technical information
Reference

90 degree elbow

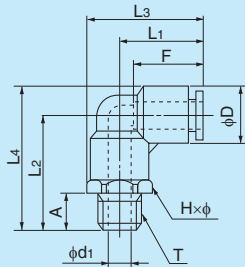

●Millimeter size type

Product number	Applicable tubing outer diameter (mm)	T Thread size (R)	L ₁ (mm)	L ₂ (mm)	L ₃ (mm)	L ₄ (mm)	A (mm)	F Tubing insertion length (mm)	H×φ Width across flat (mm)	D (mm)	d ₁ (mm)	Min. inner diameter (mm)	Effective sectional area (mm ²)	Weight (g)
EL4-R1/8-C1	4	R1/8	17.7	23.7	23.2	28.7	9.0	14	10.0×11.0	10.0	5.0	3.0	4.0	2.0
EL4-R1/4-C1	4	R1/4	17.7	27.7	25.4	32.7	12.0	14	14.0×15.4	10.0	7.0	3.0	4.0	3.0
EL6-R1/8-C1	6	R1/8	18.9	26.2	25.4	32.7	9.0	15	12.0×13.0	13.0	4.5	4.5	12.0	4.0
EL6-R1/4-C1	6	R1/4	18.9	30.2	26.6	36.7	12.0	15	14.0×15.4	13.0	7.0	4.5	12.0	4.0
EL8-R1/8-C1	8	R1/8	21.1	29.2	28.8	36.7	9.0	16	14.0×15.4	15.0	6.0	6.0	18.5	5.0
EL8-R1/4-C1	8	R1/4	21.1	31.2	28.8	38.9	12.0	16	14.0×15.4	15.0	6.5	6.5	23.0	6.0
EL10-R1/4-C1	10	R1/4	25.0	37.2	34.3	46.2	12.0	19	17.0×18.5	18.0	8.0	8.0	34.5	9.0
EL10-R3/8-C1	10	R3/8	25.0	37.2	34.3	46.2	14.0	19	17.0×18.5	18.0	9.0	8.0	37.0	11.0
EL12-R3/8-C1	12	R3/8	26.7	38.7	37.2	49.0	14.0	20	19.0×21.0	20.5	10.0	10.0	43.0	13.0
EL12-R1/2-C1	12	R1/2	26.7	41.7	38.7	52.0	16.0	20	22.0×24.0	20.5	12.0	9.5	43.0	15.0

EL6-N1/8-C1	6	NPT1/8	18.9	26.2	25.4	32.7	9.0	15	12.0×13.0	13.0	4.5	4.5	12.0	4.0
EL6-N1/4-C1	6	NPT1/4	18.9	30.2	26.6	36.7	12.0	15	14.0×15.4	13.0	7.0	4.5	12.0	4.0

●Inch size type

Product number	Applicable tubing outer diameter (inch)	T Thread size (R)	L ₁ (mm)	L ₂ (mm)	L ₃ (mm)	L ₄ (mm)	A (mm)	F Tubing insertion length (mm)	H×φ Width across flat (mm)	D (mm)	d ₁ (mm)	Min. inner diameter (mm)	Effective sectional area (mm ²)	Weight (g)
EL1/4-R1/8-C1	1/4	R1/8	19.9	26.2	26.4	32.7	9.0	16	12.0×13.0	13.0	4.5	4.5	13.0	4.0
EL1/4-R1/4-C1	1/4	R1/4	19.9	30.2	27.6	36.7	12.0	16	14.0×15.4	13.0	7.0	4.5	13.0	4.0
EL3/8-R1/4-C1	3/8	R1/4	25.8	37.2	35.1	46.2	12.0	20	17.0×18.5	18.0	8.0	8.0	30.0	9.0
EL3/8-R3/8-C1	3/8	R3/8	25.8	37.2	35.1	46.2	14.0	20	17.0×18.5	18.0	9.0	8.0	32.0	11.0
EL1/2-R3/8-C1	1/2	R3/8	28.7	38.7	39.2	49.5	14.0	23	19.0×21.0	21.5	10.0	10.0	53.0	13.0
EL1/2-R1/2-C1	1/2	R1/2	28.7	41.7	40.7	52.5	16.0	23	22.0×24.0	21.5	12.0	9.5	55.5	15.0

Tee

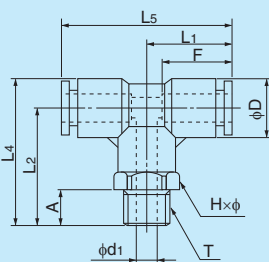

●Millimeter size type

Product number	Applicable tubing outer diameter (mm)	T Thread size (R)	L ₁ (mm)	L ₂ (mm)	L ₄ (mm)	L ₅ (mm)	A (mm)	F Tubing insertion length (mm)	H×φ Width across flat (mm)	D (mm)	d ₁ (mm)	Min. inner diameter (mm)	Effective sectional area (mm ²)	Weight (g)
ET4-R1/8-C1	4	R1/8	17.7	23.7	28.7	35.3	9.0	14	10.0×11.0	10.0	5.0	3.0	4.0	3.0
ET4-R1/4-C1	4	R1/4	17.7	27.7	32.7	35.3	12.0	14	14.0×15.4	10.0	7.0	3.0	4.0	4.0
ET6-R1/8-C1	6	R1/8	18.9	26.2	32.7	37.9	9.0	15	12.0×13.0	13.0	4.5	4.5	12.0	5.0
ET6-R1/4-C1	6	R1/4	18.9	30.2	36.7	37.9	12.0	15	14.0×15.4	13.0	7.0	4.5	12.0	6.0
ET8-R1/8-C1	8	R1/8	21.1	29.2	36.7	42.2	9.0	16	14.0×15.4	15.0	6.0	6.0	18.5	7.0
ET8-R1/4-C1	8	R1/4	21.1	31.2	38.7	42.2	12.0	16	14.0×15.4	15.0	6.5	6.5	23.0	8.0
ET10-R1/4-C1	10	R1/4	25.0	37.2	46.2	50.0	12.0	19	17.0×18.5	18.0	8.0	8.0	34.5	14.0
ET10-R3/8-C1	10	R3/8	25.0	37.2	46.2	50.0	14.0	19	17.0×18.5	18.0	9.0	8.0	37.0	16.0
ET12-R3/8-C1	12	R3/8	26.7	38.7	49.0	53.4	14.0	20	19.0×21.0	20.5	10.0	10.0	43.0	19.0
ET12-R1/2-C1	12	R1/2	26.7	41.7	52.0	53.4	16.0	20	22.0×24.0	20.5	12.0	9.5	43.0	21.0

ET6-N1/8-C1	6	NPT1/8	18.9	26.2	32.7	37.9	9.0	15	12.0×13.0	13.0	4.5	4.5	12.0	5.0
ET6-N1/4-C1	6	NPT1/4	18.9	30.2	36.7	37.9	12.0	15	14.0×15.4	13.0	7.0	4.5	12.0	6.0

●Inch size type

Product number	Applicable tubing outer diameter (inch)	T Thread size (R)	L ₁ (mm)	L ₂ (mm)	L ₄ (mm)	L ₅ (mm)	A (mm)	F Tubing insertion length (mm)	H×φ Width across flat (mm)	D (mm)	d ₁ (mm)	Min. inner diameter (mm)	Effective sectional area (mm ²)	Weight (g)
ET1/4-R1/8-C1	1/4	R1/8	19.9	26.2	32.7	39.8	9.0	16	12.0×13.0	13.0	4.5	4.5	13.0	5.0
ET1/4-R1/4-C1	1/4	R1/4	19.9	30.2	36.7	39.8	12.0	16	14.0×15.4	13.0	7.0	4.5	13.0	6.0
ET3/8-R1/4-C1	3/8	R1/4	25.8	37.2	46.2	51.6	12.0	20	17.0×18.5	18.0	8.0	8.0	30.0	14.0
ET3/8-R3/8-C1	3/8	R3/8	25.8	37.2	46.2	51.6	14.0	20	17.0×18.5	18.0	9.0	8.0	32.0	16.0
ET1/2-R3/8-C1	1/2	R3/8	29.7	39.0	49.8	59.5	14.0	23	19.0×21.0	21.5	10.0	10.0	53.0	19.0
ET1/2-R1/2-C1	1/2	R1/2	29.7	42.0	52.8	59.5	16.0	23	22.0×24.0	21.5	12.0	9.5	55.5	21.0

Tubing

Clean tubing

Processed tubing

PushOne fitting

QuickSeal fitting

Clean fitting/ Chemifit

Bamboo-shoot fitting

Control switch/ Detachable series

Jig/Tool/ Accessory

Technical information

Reference

Service tee

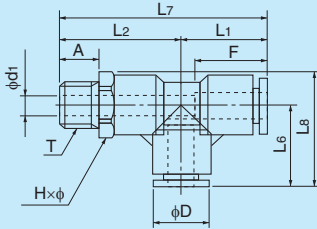

●Millimeter size type

Product number	Applicable tubing outer diameter (mm)	T Thread size (R)	L ₁ (mm)	L ₂ (mm)	L ₆ (mm)	L ₇ (mm)	L ₈ (mm)	A (mm)	F Tubing insertion length (mm)	H×φ Width across flat (mm)	D (mm)	d ₁ (mm)	Min. inner diameter (mm)	Effective sectional area (mm ²)	Weight (g)
EST4-R1/8-C1	4	R1/8	17.7	23.7	17.7	41.4	23.2	9.0	14	10.0×11.0	10.0	5.0	3.0	4.0	3.0
EST4-R1/4-C1	4	R1/4	17.7	27.7	17.7	45.4	25.4	12.0	14	14.0×15.4	10.0	7.0	3.0	4.0	4.0
EST6-R1/8-C1	6	R1/8	18.9	26.2	18.9	45.1	25.4	9.0	15	12.0×13.0	13.0	4.5	4.5	12.0	5.0
EST6-R1/4-C1	6	R1/4	18.9	30.2	18.9	49.1	26.6	12.0	15	14.0×15.4	13.0	7.0	4.5	12.0	6.0
EST8-R1/8-C1	8	R1/8	21.1	29.2	21.1	50.3	28.8	9.0	16	14.0×15.4	15.0	6.0	6.0	18.5	7.0
EST8-R1/4-C1	8	R1/4	21.1	31.2	21.1	52.3	28.8	12.0	16	14.0×15.4	15.0	6.5	6.5	23.0	8.0
EST10-R1/4-C1	10	R1/4	25.0	37.2	25.0	62.2	34.3	12.0	19	17.0×18.5	18.0	8.0	8.0	34.5	14.0
EST10-R3/8-C1	10	R3/8	25.0	37.2	25.0	62.2	34.3	14.0	19	17.0×18.5	18.0	9.0	8.0	37.0	16.0
EST12-R3/8-C1	12	R3/8	26.7	38.7	26.7	65.4	37.2	14.0	20	19.0×21.0	20.5	10.0	10.0	43.0	19.0
EST12-R1/2-C1	12	R1/2	26.7	41.7	26.7	68.4	38.7	16.0	20	22.0×24.0	20.5	12.0	9.5	43.0	21.0

EST6-N1/8-C1	6	NPT1/8	18.9	26.2	18.9	45.1	25.4	9.0	15	12.0×13.0	13.0	4.5	4.5	12.0	5.0
EST6-N1/4-C1	6	NPT1/4	18.9	30.2	18.9	49.1	26.6	12.0	15	14.0×15.4	13.0	7.0	4.5	12.0	6.0

●Inch size type

Product number	Applicable tubing outer diameter (inch)	T Thread size (R)	L ₁ (mm)	L ₂ (mm)	L ₆ (mm)	L ₇ (mm)	L ₈ (mm)	A (mm)	F Tubing insertion length (mm)	H×φ Width across flat (mm)	D (mm)	d ₁ (mm)	Min. inner diameter (mm)	Effective sectional area (mm ²)	Weight (g)
EST1/4-R1/8-C1	1/4	R1/8	19.9	26.2	19.9	46.1	26.4	9.0	16	12.0×13.0	13.0	4.5	4.5	13.0	5.0
EST1/4-R1/4-C1	1/4	R1/4	19.9	30.2	19.9	50.1	27.6	12.0	16	14.0×15.4	13.0	7.0	4.5	13.0	6.0
EST3/8-R1/4-C1	3/8	R1/4	25.8	37.2	25.8	63.0	35.1	12.0	20	17.0×18.5	18.0	8.0	8.0	30.0	14.0
EST3/8-R3/8-C1	3/8	R3/8	25.8	37.2	25.8	63.0	35.1	14.0	20	17.0×18.5	18.0	9.0	8.0	32.0	16.0
EST1/2-R3/8-C1	1/2	R3/8	29.7	39.0	29.7	68.7	40.2	14.0	23	19.0×21.0	21.5	10.0	10.0	53.0	19.0
EST1/2-R1/2-C1	1/2	R1/2	29.7	42.0	29.7	71.7	41.7	16.0	23	22.0×24.0	21.5	12.0	9.5	55.5	21.0

Y joint

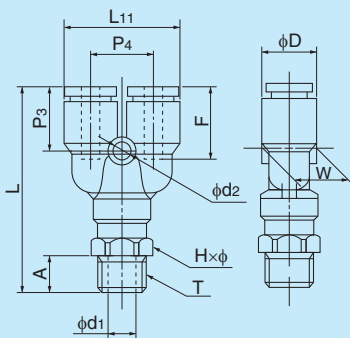

●Millimeter size type

Product number	Applicable tubing outer diameter (mm)	T Thread size (R)	L (mm)	L ₁₁ (mm)	A (mm)	F Tubing insertion length (mm)	H×φ Width across flat (mm)	P ₃ (mm)	P ₄ (mm)	W (mm)	D (mm)	d ₁ (mm)	d ₂ (mm)	Min. inner diameter (mm)	Effective sectional area (mm ²)	Weight (g)
EY4-R1/8-C1	4	R1/8	41.9	21.0	9.0	14	10.0×11.0	13.9	11.0	9.7	10.0	5.0	3.2	3.0	3.5	4.0
EY4-R1/4-C1	4	R1/4	45.9	21.0	12.0	14	14.0×15.4	13.9	11.0	9.7	10.0	7.0	3.2	3.0	3.5	5.0
EY6-R1/8-C1	6	R1/8	45.2	25.2	9.0	15	12.0×13.0	15.2	12.2	12.5	13.0	4.5	4.2	4.5	9.0	6.0
EY6-R1/4-C1	6	R1/4	49.2	25.2	12.0	15	14.0×15.4	15.2	12.2	12.5	13.0	7.0	4.2	4.5	9.0	7.0
EY8-R1/8-C1	8	R1/8	50.3	29.2	9.0	16	14.0×15.4	16.8	14.2	14.5	15.0	6.0	4.2	6.0	17.5	8.0
EY8-R1/4-C1	8	R1/4	52.3	29.2	12.0	16	14.0×15.4	16.8	14.2	14.5	15.0	6.5	4.2	6.5	20.0	9.0
EY10-R1/4-C1	10	R1/4	60.2	35.5	12.0	19	17.0×18.5	18.7	17.5	17.5	18.0	8.0	4.2	8.0	27.5	15.0
EY10-R3/8-C1	10	R3/8	60.2	35.5	14.0	19	17.0×18.5	18.7	17.5	17.5	18.0	9.0	4.2	8.0	28.0	16.0
EY12-R3/8-C1	12	R3/8	64.2	40.5	14.0	20	19.0×21.0	20.7	20.0	20.0	20.5	10.0	4.2	10.0	40.0	22.0
EY12-R1/2-C1	12	R1/2	67.2	40.5	16.0	20	22.0×24.0	20.7	20.0	20.0	20.5	12.0	4.2	9.5	40.0	23.0

EY6-N1/8-C1	6	NPT1/8	45.2	25.2	9.0	15	12.0×13.0	15.2	12.2	12.5	13.0	4.5	4.2	4.5	9.0	6.0
EY6-N1/4-C1	6	NPT1/4	49.2	25.2	12.0	15	14.0×15.4	15.2	12.2	12.5	13.0	7.0	4.2	4.5	9.0	7.0

●Inch size type

Product number	Applicable tubing outer diameter (inch)	T Thread size (R)	L (mm)	L ₁₁ (mm)	A (mm)	F Tubing insertion length (mm)	H×φ Width across flat (mm)	P ₃ (mm)	P ₄ (mm)	W (mm)	D (mm)	d ₁ (mm)	d ₂ (mm)	Min. inner diameter (mm)	Effective sectional area (mm ²)	Weight (g)
EY1/4-R1/8-C1	1/4	R1/8	46.2	25.2	9.0	16	12.0×13.0	16.2	12.2	12.5	13.0	4.5	4.2	4.5	10.5	6.0
EY1/4-R1/4-C1	1/4	R1/4	50.2	25.2	12.0	16	14.0×15.4	16.2	12.2	12.5	13.0	7.0	4.2	4.5	10.5	7.0
EY3/8-R1/4-C1	3/8	R1/4	61.0	35.5	12.0	20	17.0×18.5	19.5	17.5	17.5	18.0	8.0	4.2	8.0	26.0	15.0
EY3/8-R3/8-C1	3/8	R3/8	61.0	35.5	14.0	20	17.0×18.5	19.5	17.5	17.5	18.0	9.0	4.2	8.0	26.0	16.0
EY1/2-R3/8-C1	1/2	R3/8	67.7	42.5	14.0	23	19.0×21.0	22.7	21.0	21.0	21.5	10.0	4.2	10.0	48.0	22.0
EY1/2-R1/2-C1	1/2	R1/2	70.7	42.5	16.0	23	22.0×24.0	22.7	21.0	21.0	21.5	12.0	4.2	9.5	48.0	23.0

Union connector



●Millimeter size type

Product number	d1 Applicable tubing outer diameter (mm)	d2 Applicable tubing outer diameter (mm)	L	L1	P1	F1 Tubing insertion length (mm)	F2 Tubing insertion length (mm)	d3	D1	D2	W	Min. inner diameter (mm)	Effective sectional area (mm ²)	Weight (g)
EUC3-C1	3	3	23.2	11.6	3.6	11	11	3.2	6.3	6.3	6.0	2.0	2.5	—
EUC4-C1	4	4	32.7	16.4	5.0	14	14	4.2	10.0	10.0	9.7	3.0	3.5	2.0
EUC6-C1	6	6	34.5	17.2	6.0	15	15	4.2	13.0	13.0	12.5	5.0	12.5	4.0
EUC8-C1	8	8	36.6	18.3	7.0	16	16	4.2	15.0	15.0	14.5	7.0	28.0	5.0
EUC10-C1	10	10	42.4	21.2	8.5	19	19	4.2	18.0	18.0	17.5	9.0	45.0	10.0
EUC12-C1	12	12	44.4	22.2	9.8	20	20	4.2	20.5	20.5	20.0	11.0	67.0	14.0

●Inch size type

Product number	d1 Applicable tubing outer diameter (inch)	d2 Applicable tubing outer diameter (inch)	L	L1	P1	F1 Tubing insertion length (mm)	F2 Tubing insertion length (mm)	d3	D1	D2	W	Min. inner diameter (mm)	Effective sectional area (mm ²)	Weight (g)
EUC1/8-C1	1/8	1/8	25.9	13.0	4.5	12	12	3.2	8.0	8.0	8.0	2.5	—	—
EUC1/4-C1	1/4	1/4	36.4	18.2	6.0	16	16	4.2	13.0	13.0	12.5	5.0	12.5	4.0
EUC3/8-C1	3/8	3/8	44.0	22.0	8.5	20	20	4.2	18.0	18.0	17.5	9.0	28.0	10.0
EUC1/2-C1	1/2	1/2	48.5	24.2	10.3	23	23	4.2	21.5	21.5	20.0	11.0	35.0	19.0

●Inch size type (different diameter connection)

Product number	d1 Applicable tubing outer diameter (inch)	d2 Applicable tubing outer diameter (inch)	L	L1	P1	F1 Tubing insertion length (mm)	F2 Tubing insertion length (mm)	d3	D1	D2	W	Min. inner diameter (mm)	Effective sectional area (mm ²)	Weight (g)
EUC1/8-1/4-C1	1/8	1/4	34.4	18.2	6.0	12	16	4.2	10.0	13.0	12.5	2.5	—	—
EUC1/4-3/8-C1	1/4	3/8	40.7	22.0	8.5	16	20	4.2	15.0	18.0	17.5	5.0	—	—
EUC3/8-1/2-C1	3/8	1/2	46.2	24.2	9.8	20	23	4.2	18.0	21.5	20.0	9.0	—	—

●Inch size — millimeter size connection

Product number	d1 Applicable tubing outer diameter (inch)	d2 Applicable tubing outer diameter (mm)	L	L1	P1	F1 Tubing insertion length (mm)	F2 Tubing insertion length (mm)	d3	D1	D2	W	Min. inner diameter (mm)	Effective sectional area (mm ²)	Weight (g)
EUC1/4-6-C1	1/4	6	35.4	17.2	6.0	16	15	4.2	13.0	13.0	12.5	5.0	12.5	4.0
EUC3/8-10-C1	3/8	10	43.2	21.2	8.5	20	19	4.2	18.0	18.0	17.5	9.0	45.0	10.0

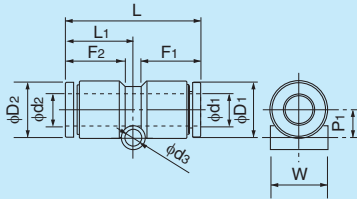

90 degree union elbow



●Millimeter size type

Product number	Applicable tubing outer diameter (mm)	L1	L8	P1	F Tubing insertion length (mm)	d3	D	W	Min. inner diameter (mm)	Effective sectional area (mm ²)	Weight (g)
EUL3-C1	3	12.6	15.7	4.1	11	3.2	6.3	6	2.0	2.0	—
EUL4-C1	4	17.7	22.7	6.9	14	4.2	10.0	9.7	3.0	3.5	3.0
EUL6-C1	6	18.9	25.4	8.3	15	4.2	13.0	12.5	5.0	9.5	4.0
EUL8-C1	8	21.1	28.6	9.3	16	4.2	15.0	14.5	7.0	19.5	6.0
EUL10-C1	10	25.0	34.0	10.8	19	4.2	18.0	17.5	9.0	32.5	12.0
EUL12-C1	12	26.7	37.0	12.1	20	4.2	20.5	20.0	11.0	45.5	16.0

●Inch size type

Product number	Applicable tubing outer diameter (mm)	L1	L8	P1	F Tubing insertion length (mm)	d3	D	W	Min. inner diameter (mm)	Effective sectional area (mm ²)	Weight (g)
EUL1/8-C1	1/8	15.2	19.2	5.0	12	3.2	8.0	8.0	3.0	—	—
EUL1/4-C1	1/4	19.9	26.4	8.3	16	4.2	13.0	12.5	5.0	12.0	4.0
EUL3/8-C1	3/8	25.8	34.8	10.8	20	4.2	18.0	17.5	9.0	27.0	12.0
EUL1/2-C1	1/2	29.7	40.5	12.6	23	4.2	21.5	21.0	11.0	54.5	20.0

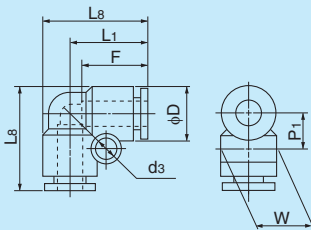

Union tee

●Millimeter size type



Product number	Applicable tubing outer diameter (mm)	L ₁ (mm)	L ₅ (mm)	L ₆ (mm)	L ₈ (mm)	P ₁ (mm)	P ₂ (mm)	F Tubing insertion length (mm)	D (mm)	d ₂ (mm)	W (mm)	Min. inner diameter (mm)	Effective sectional area (mm ²)	Weight (g)
EUT3-C1	3	12.6	25.1	12.6	15.7	4.1	8.2	11	6.3	3.2	6	2.0	2.0	1.5
EUT4-C1	4	17.7	35.3	17.7	22.7	6.9	14.0	14	10.0	4.2	9.7	3.0	3.5	4.0
EUT6-C1	6	18.9	37.9	18.9	25.4	8.3	17.0	15	13.0	4.2	12.5	5.0	9.5	7.0
EUT8-C1	8	21.1	42.2	21.1	28.6	9.3	19.0	16	15.0	4.2	14.5	7.0	19.5	9.0
EUT10-C1	10	25.0	50.0	25.0	34.0	10.8	22.0	19	18.0	4.2	17.5	9.0	32.5	17.0
EUT12-C1	12	26.7	53.4	26.7	37.0	12.1	24.0	20	20.5	4.2	20.0	11.0	45.5	23.0

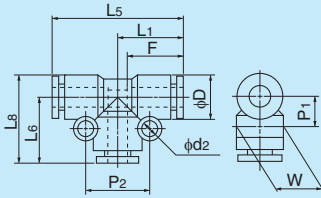

●Inch size type

Product number	Applicable tubing outer diameter (inch)	L ₁ (mm)	L ₅ (mm)	L ₆ (mm)	L ₈ (mm)	P ₁ (mm)	P ₂ (mm)	F Tubing insertion length (mm)	D (mm)	d ₂ (mm)	W (mm)	Min. inner diameter (mm)	Effective sectional area (mm ²)	Weight (g)
EUT1/8-C1	1/8	15.2	30.4	15.2	19.2	5.0	10.0	12	8.0	3.2	8.0	3.0	—	—
EUT1/4-C1	1/4	19.9	39.8	19.9	26.4	8.3	17.0	16	13.0	4.2	12.5	5.0	12.0	7.0
EUT3/8-C1	3/8	25.8	51.6	25.8	34.8	10.8	22.0	20	18.0	4.2	17.5	9.0	27.0	17.0
EUT1/2-C1	1/2	29.7	59.5	29.7	40.5	12.6	25.0	23	21.5	4.2	21.0	11.0	54.5	29.0

Y union

●Millimeter size type



Product number	Applicable tubing outer diameter (mm)	L (mm)	L ₁₁ (mm)	F Tubing insertion length (mm)	P ₃ (mm)	P ₄ (mm)	W (mm)	D (mm)	d ₂ (mm)	Min. inner diameter (mm)	Effective sectional area (mm ²)	Weight (g)
EYB3-C1	3	25.7	13.3	11	10.9	7.0	6.0	6.3	2.0	2.0	2	—
EYB4-C1	4	34.7	21.0	14	13.9	11.0	9.7	10.0	3.2	3.0	3.0	4.0
EYB6-C1	6	38.4	25.2	15	15.2	12.2	12.5	13.0	4.2	5.0	8.0	6.0
EYB8-C1	8	43.7	29.2	16	16.8	14.2	14.5	15.0	4.2	7.0	18.0	9.0
EYB10-C1	10	49.0	35.5	19	18.7	17.5	17.5	18.0	4.2	9.0	27.0	17.0
EYB12-C1	12	54.8	40.5	20	20.7	20.0	20.0	20.5	4.2	11.0	38.5	24.0

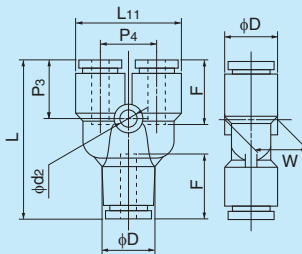

●Inch size type

Product number	Applicable tubing outer diameter (inch)	L (mm)	L ₁₁ (mm)	F Tubing insertion length (mm)	P ₃ (mm)	P ₄ (mm)	W (mm)	D (mm)	d ₂ (mm)	Min. inner diameter (mm)	Effective sectional area (mm ²)	Weight (g)
EYB1/8-C1	1/8	29.4	17.0	12	11.7	9.0	8.0	8.0	3.2	3.0	—	—
EYB1/4-C1	1/4	40.3	25.2	16	16.2	12.2	12.5	13.0	4.2	5.0	10.5	10.0
EYB3/8-C1	3/8	50.6	35.5	20	19.5	17.5	17.5	18.0	4.2	9.0	24.0	24.0
EYB1/2-C1	1/2	60.4	42.5	23	22.7	21.0	21.0	21.5	4.2	11.0	46.5	33.0

Panel touch connector

●Millimeter size type



Product number	Applicable tubing outer diameter (mm)	L (mm)	F Tubing insertion length (mm)	H ₄ (mm)	t Max. panel thickness (mm)	T ₁ Recommended panel hole diameter (mm)	Washer outer diameter (mm)	Washer thickness (mm)	Min. inner diameter (mm)	Effective sectional area (mm ²)	Weight (g)
EPC4-C1	4	32.7	14	17.0	7.5	13	24.0	2.5	3.0	3.5	5.0
EPC6-C1	6	34.5	15	19.0	9.5	15	28.0	2.5	5.0	12.5	7.0
EPC8-C1	8	36.6	16	22.0	10.0	17	30.0	3.0	7.0	28.0	9.0
EPC10-C1	10	42.4	19	27.0	14.0	21	37.0	3.0	9.0	45.0	16.0
EPC12-C1	12	44.4	20	30.0	16.0	23	39.0	3.0	11.0	67.0	67.0

●Inch size type

Product number	Applicable tubing outer diameter (inch)	L (mm)	F Tubing insertion length (mm)	H ₄ (mm)	t Max. panel thickness (mm)	T ₁ Recommended panel hole diameter (mm)	Washer outer diameter (mm)	Washer thickness (mm)	Min. inner diameter (mm)	Effective sectional area (mm ²)	Weight (g)
EPC1/4-C1	1/4	36.4	16	19.0	9.5	15	28.0	2.5	5.0	12.5	7.0
EPC3/8-C1	3/8	44.0	20	27.0	14.0	21	37.0	3.0	9.0	45.0	16.0
EPC1/2-C1	1/2	48.5	23	30.0	16.0	23	39.0	3.0	10.0	67.0	67.0

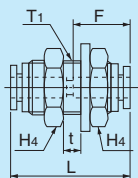

*Made to order

Reducer

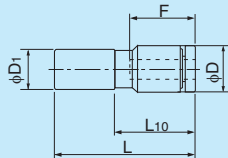

●Millimeter size type

Product number	Applicable tubing outer diameter (mm)	D1 Insertion part diameter (mm)	L (mm)	L10 (mm)	F Tubing insertion length (mm)	D (mm)	Min. inner diameter (mm)	Effective sectional area (mm ²)	Weight (g)
ER4-6-C1	4	6	34.5	18.0	14	10.0	3.0	3.5	2.0
ER4-8-C1	4	8	32.0	18.8	14	10.0	3.0	3.5	2.0
ER6-8-C1	6	8	34.7	17.7	15	13.0	5.0	10.5	2.0
ER6-10-C1	6	10	35.6	20.6	15	13.0	5.0	10.5	3.0
ER8-10-C1	8	10	39.4	18.9	16	15.0	7.0	28.0	3.0
ER8-12-C1	8	12	38.3	16.3	16	15.0	7.0	28.0	4.0
ER10-12-C1	10	12	42.8	20.8	19	18.0	9.0	45.0	8.0

●Inch size type

Product number	Applicable tubing outer diameter (inch)	D1 Insertion part diameter (inch)	L (mm)	L10 (mm)	F Tubing insertion length (mm)	D (mm)	Min. inner diameter (mm)	Effective sectional area (mm ²)	Weight (g)
ER1/4-3/8-C1	1/4	3/8	35.2	16.4	16	13.0	5.0	12.0	3.0

Manifold

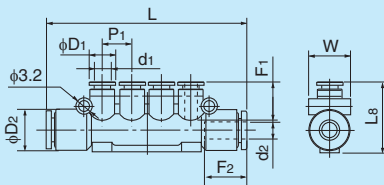

●Inch size type

Product number	d1 Applicable tubing outer diameter (inch)	d2 Applicable tubing outer diameter (inch)	L (mm)	P1 (mm)	L8 (mm)	F1 Tubing insertion length (mm)	F2 Tubing insertion length (mm)	D1 (mm)	D2 (mm)	W (mm)	Weight (g)
EMA1/8-1/4-4S-C1	1/8	1/4	65.7	9.0	21.7	12	16	8.0	13.0	12.6	—

Blank plug

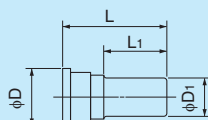

●Millimeter size type

Product number	D1 Insertion part diameter (mm)	L (mm)	L1 (mm)	D (mm)	Weight (g)
BC3-C1	3	23.5	13.0	5.0	0.5
BC4-C1	4	28.0	15.5	7.7	0.5
BC6-C1	6	28.0	16.0	9.7	0.8
BC8-C1	8	29.0	16.0	11.7	1.1
BC10-C1	10	32.0	17.7	14.0	1.6
BC12-C1	12	34.0	20.4	16.0	2.4

●Inch size type

Product number	D1 Insertion part diameter (inch)	L (mm)	L1 (mm)	D (mm)	Weight (g)
BC1/8-C1	1/8	26.0	13.5	7.7	—
BC1/4-C1	1/4	28.0	16.0	9.7	1.2
BC3/8-C1	3/8	32.0	17.7	14.0	2.5
BC1/2-C1	1/2	34.0	20.4	16.0	3.8

Tubing

Clean tubing

Processed tubing

PushOne fitting

QuickSeal fitting

Clean fitting/ Chemifit

Bamboo-shoot fitting

Control switch/ Detachable series

Jig/Tool/ Accessory

Technical information

Reference

Chemifit™ C1S Series

PushOne™ fitting for clean air, pure water and chemical liquids

Features

- **Made in oil-free process**
Assembled after cleaning each part in a clean room. No oil or fat is used in the sealing materials.
- **PushOne connection of tubing**
The tubes can be connected without using a jig or tools.
- **SUS304 thread**
High thread strength.
- **Double clean package**
Each fitting is packed in a clean room and put in a zipper sealed bag.
- **Easy directional setting of tubing**
The direction of elbows, tees, etc., can be decided at the time of piping installation.

Cross-sectional structure diagram

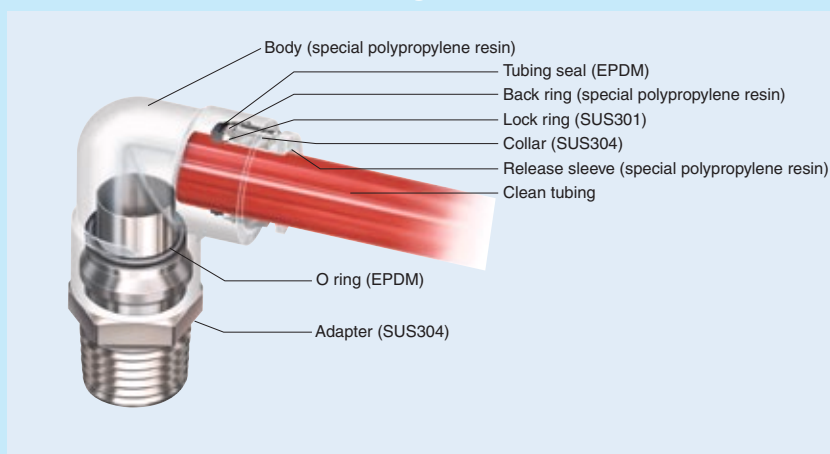

Product number example

EL 6 - R1/4 - C1S

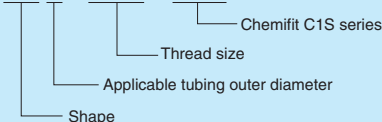

Distinction of millimeter/inch sizes

- The tubing size is shown on the release sleeve.



Operating fluid, working temperature range

Operating fluid	Working temperature range
Air (clean air)	-20°C~+80°C
Water (pure water)	0°C~+80°C

- ☞ Contact us for various chemical liquids.
- ☞ See "Combination List of Tubing and Fitting" on page 8.

Pressure condition

Maximum working pressure: 0.7MPa (at 20°C)
Negative pressure performance: -99.975kPa

Relation between the working temperature and the maximum working pressure

Maximum working pressure varies with working temperature (environmental temperature). For use at an abnormal temperature, always check the maximum working pressure change in the graph below and keep pressure within the range.

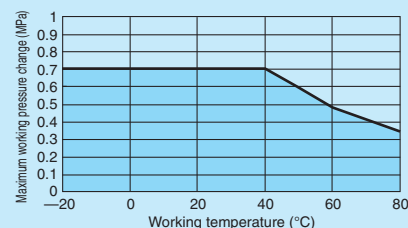

Handling instructions

- ⚠ **Caution:** When the working conditions of tubes and fittings differ, use them under the lower specified conditions.
- ⚠ **Caution:** When water is used as the operating fluid, do not allow it to freeze.
- ⚠ **Caution:** Do not bend the pipe sharply near the tubing insertion port (sleeve end) of the fitting. Keep the tubing straight for twice as long as the tubing diameter from the insertion port.

- ☞ See page 34 for the common handling instructions for fittings.

Applicable tubing

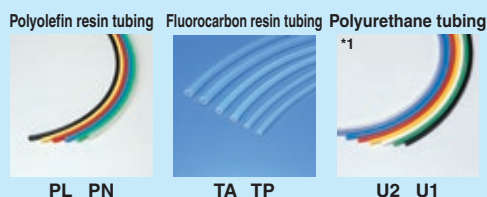

Related products and product introduction



Reference

Instruction manualP.176
Chemical resistance specification tableP.198
Effective sectional area ..P.168
Negative-pressure performance listP.169

(*1) Combinatory use of U2 or U1 tubing and Chemifit C1S series mixes general and clean type performances. When using them together in a clean environment, be aware of how this could lower the cleanliness level.

Chemifit™ C1S Series

Shape list



See Chemifit C1 series for union type shape.

Tubing

Clean tubing

Processed tubing

PushOne fitting

QuickSeal fitting

Clean fitting/
Chemifit

Bamboo-shoot fitting

Control switch/
Detachable series

Jig/Tool/
Accessory

Technical information

Reference

Oil-free processing, Clean wrapping and packaging

● Ultrasonic cleaning with no oil or fat used for assembling in a clean room.

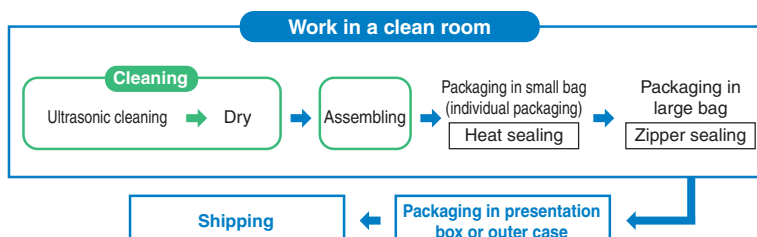

● High-barrier sheet packaging available

What is high-barrier sheet packaging?

In order to maintain the cleanliness of our products, no space for oxygen, water, or corrosive gas is allowed inside the package so a packaging bag with a high gas barrier is needed for protecting the content from these gases. To meet this requirement, Nitta provides high-barrier bags with a high gas barrier performance also for nitrogen sealing or atmospheric sealing.



- The packaging bags that Nitta uses have the highest gas barrier performance among clear bags.
- The bags do not contain halogen, etc., for safe burning.

Connector

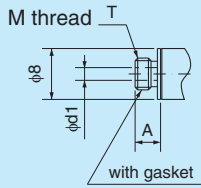
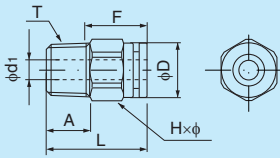

●Millimeter size type

Product number	Applicable tubing outer diameter (mm)	T Thread size (R,M)	L (mm)	A (mm)	F Tubing insertion length (mm)	H x phi Width across flat (mm)	D (mm)	d1 (mm)	Effective sectional area (mm ²)	Weight (g)
EC3-M5-C1S	3	M5x0.8	15.9	3.5	11	7.0x7.7	5.5	2.0	2.0	2.0
EC4-M5-C1S	4	M5x0.8	19.4	4.0	14	10.0x11.0	10.0	2.0	3.0	6.0
EC4-R1/8-C1S	4	R1/8	19.4	8.0	14	10.0x11.0	10.0	2.5	4.0	7.0
EC6-M5-C1S	6	M5x0.8	23.2	4.0	15	12.0x13.0	12.0	2.0	3.5	9.0
EC6-R1/8-C1S	6	R1/8	21.6	8.0	15	12.0x13.0	12.0	4.0	10.5	9.0
EC6-R1/4-C1S	6	R1/4	24.6	11.0	15	14.0x15.4	12.0	4.0	10.5	18.0
EC8-R1/8-C1S	8	R1/8	28.2	9.0	16	14.0x15.4	13.9	6.0	20.0	14.0
EC8-R1/4-C1S	8	R1/4	25.2	11.0	16	14.0x15.4	13.9	6.0	25.0	16.0
EC10-R1/4-C1S	10	R1/4	28.1	11.0	19	17.0x18.5	16.9	8.0	40.0	21.0
EC10-R3/8-C1S	10	R3/8	29.1	12.0	19	17.0x18.5	16.9	8.0	40.0	29.0
EC12-R3/8-C1S	12	R3/8	30.0	12.0	20	19.0x21.0	19.0	10.0	50.0	31.0
EC12-R1/2-C1S	12	R1/2	33.0	15.0	20	22.0x24.0	19.0	10.0	50.0	58.0

●Inch size type

Product number	Applicable tubing outer diameter (inch)	T Thread size (M)	L (mm)	A (mm)	F Tubing insertion length (mm)	H x phi Width across flat (mm)	D (mm)	d1 (mm)	Effective sectional area (mm ²)	Weight (g)
EC1/8-M5-C1S	1/8	M5x0.8	16.2	3.5	11	8.0x8.8	8	2.5	—	—

Internal connector

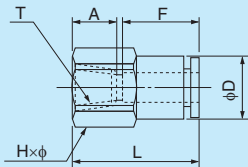

●Millimeter size type

Product number	Applicable tubing outer diameter (mm)	T Thread size (RC)	L (mm)	A (mm)	F Tubing insertion length (mm)	H x phi Width across flat (mm)	D (mm)	Effective sectional area (mm ²)	Weight (g)
EFC4-R1/8-C1S	4	RC1/8	23.9	8.7	14	14.0x15.4	10.0	4.0	16.0
EFC6-R1/8-C1S	6	RC1/8	25.0	8.7	15	14.0x15.4	12.0	10.5	17.0
EFC6-R1/4-C1S	6	RC1/4	29.5	13.0	15	17.0x18.5	12.0	10.5	26.0
EFC8-R1/4-C1S	8	RC1/4	30.9	13.0	16	17.0x18.5	13.9	25.0	28.0
EFC10-R1/4-C1S	10	RC1/4	33.9	13.0	19	17.0x18.5	16.9	40.0	34.0
EFC10-R3/8-C1S	10	RC3/8	34.4	13.5	19	22.0x24.5	16.9	40.0	50.0
EFC10-R1/2-C1S	10	RC1/2	38.4	17.5	19	24.0x26.5	16.9	40.0	56.0
EFC12-R3/8-C1S	12	RC3/8	35.3	13.5	20	22.0x24.5	19.0	50.0	50.0
EFC12-R1/2-C1S	12	RC1/2	39.3	17.5	20	24.0x26.5	19.0	50.0	58.0

90 degree elbow

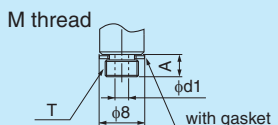
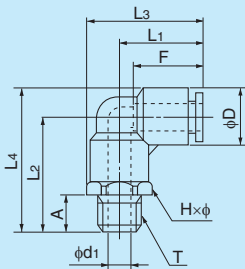

●Millimeter size type

Product number	Applicable tubing outer diameter (mm)	T Thread size (R,M)	L1 (mm)	L2 (mm)	L3 (mm)	L4 (mm)	A (mm)	F Tubing insertion length (mm)	H x phi Width across flat (mm)	D (mm)	d1 (mm)	Min. inner diameter (mm)	Effective sectional area (mm ²)	Weight (g)
EL3-M5-C1S	3	M5x0.8	12.6	13.0	16.4	16.2	3.5	11	7.0x7.7	6.3	2.5	1.5	1.5	—
EL4-M5-C1S	4	M5x0.8	17.7	20.2	23.2	25.2	4.0	14	10.0x11.0	10.0	2.0	2.0	3.0	7.0
EL4-R1/8-C1S	4	R1/8	17.7	22.7	23.2	27.7	8.0	14	10.0x11.0	10.0	5.0	3.0	4.0	9.0
EL6-M5-C1S	6	M5x0.8	18.9	22.7	25.4	29.2	4.0	15	12.0x13.0	13.0	2.0	2.0	3.5	10.0
EL6-R1/8-C1S	6	R1/8	18.9	25.2	25.4	31.7	8.0	15	12.0x13.0	13.0	5.0	4.5	12.0	18.0
EL6-R1/4-C1S	6	R1/4	18.9	29.2	26.6	35.7	11.0	15	14.0x15.4	13.0	7.0	4.5	12.0	18.0
EL8-R1/8-C1S	8	R1/8	21.1	27.2	28.8	34.7	8.0	16	14.0x15.4	15.0	6.5	6.5	18.5	15.0
EL8-R1/4-C1S	8	R1/4	21.1	31.2	28.8	38.7	12.0	16	14.0x15.4	15.0	6.5	6.5	23.0	20.0
EL10-R1/4-C1S	10	R1/4	25.0	37.2	34.3	46.2	12.0	19	17.0x18.5	18.0	8.0	8.0	34.5	27.0
EL10-R3/8-C1S	10	R3/8	25.0	37.2	34.3	46.2	14.0	19	17.0x18.5	18.0	9.0	8.0	37.0	33.0
EL12-R3/8-C1S	12	R3/8	26.7	38.7	37.2	49.0	14.0	20	19.0x21.0	20.5	10.0	10.0	43.0	39.0
EL12-R1/2-C1S	12	R1/2	26.7	41.7	38.7	52.0	16.0	20	22.0x24.0	20.5	12.0	9.5	43.0	56.0

●Inch size type

Product number	Applicable tubing outer diameter (inch)	T Thread size (M)	L1 (mm)	L2 (mm)	L3 (mm)	L4 (mm)	A (mm)	F Tubing insertion length (mm)	H x phi Width across flat (mm)	D (mm)	d1 (mm)	Min. inner diameter (mm)	Effective sectional area (mm ²)	Weight (g)
EL1/8-M5-C1S	1/8	M5x0.8	14.7	12.0	19.1	16.0	3.5	11	8.0x8.8	8	2.5	2.5	—	—

Tubing
Clean tubing
Processed tubing
PushOne fitting
QuickSeal fitting
Clean fitting/ Chemifit
Bamboo-shoot fitting
Control switch/ Detachable series
Jig/Tool/ Accessory
Technical information
Reference

Tee

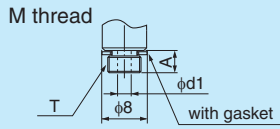
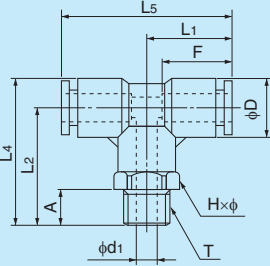

●Millimeter size type

Product number	Applicable tubing outer diameter (mm)	T Thread size (R,M)	L1 (mm)	L2 (mm)	L4 (mm)	L5 (mm)	A (mm)	F Tubing insertion length (mm)	H×φ Width across flat (mm)	D (mm)	d1 (mm)	Min. inner diameter (mm)	Effective sectional area (mm ²)	Weight (g)
ET3-M5-C1S	3	M5×0.8	12.6	13.0	16.2	25.1	3.5	11	7.0×7.7	6.3	2.5	1.5	1.5	2.0
ET4-M5-C1S	4	M5×0.8	17.7	20.2	25.2	35.3	4.0	14	10.0×11.0	10.0	2.0	2.0	3.0	8.0
ET4-R1/8-C1S	4	R1/8	17.7	22.7	27.7	35.3	8.0	14	10.0×11.0	10.0	5.0	3.0	4.0	10.0
ET6-M5-C1S	6	M5×0.8	18.9	22.7	29.2	37.9	4.0	15	12.0×13.0	13.0	2.0	2.0	3.5	12.0
ET6-R1/8-C1S	6	R1/8	18.9	25.2	31.7	37.9	8.0	15	12.0×13.0	13.0	5.0	4.5	12.0	14.0
ET6-R1/4-C1S	6	R1/4	18.9	29.2	35.7	37.9	11.0	15	14.0×15.4	13.0	7.0	4.5	12.0	21.0
ET8-R1/8-C1S	8	R1/8	21.1	27.2	34.7	42.2	8.0	16	14.0×15.4	15.0	6.5	6.5	18.5	18.0
ET8-R1/4-C1S	8	R1/4	21.1	31.2	38.7	42.2	12.0	16	14.0×15.4	15.0	6.5	6.5	23.0	24.0
ET10-R1/4-C1S	10	R1/4	25.0	37.2	46.2	50.0	12.0	19	17.0×18.5	18.0	8.0	8.0	34.5	34.0
ET10-R3/8-C1S	10	R3/8	25.0	37.2	46.2	50.0	14.0	19	17.0×18.5	18.0	9.0	8.0	37.0	39.0
ET12-R3/8-C1S	12	R3/8	26.7	38.7	49.0	53.4	14.0	20	19.0×21.0	20.5	10.0	10.0	43.0	48.0
ET12-R1/2-C1S	12	R1/2	26.7	41.7	52.0	53.4	16.0	20	22.0×24.0	20.5	12.0	9.5	43.0	65.0

*Made to order

●Inch size type

Product number	Applicable tubing outer diameter (inch)	T Thread size (M)	L1 (mm)	L2 (mm)	L4 (mm)	L5 (mm)	A (mm)	F Tubing insertion length (mm)	H×φ Width across flat (mm)	D (mm)	d1 (mm)	Min. inner diameter (mm)	Effective sectional area (mm ²)	Weight (g)
ET1/8-M5-C1S	1/8	M5×0.8	15.2	12.0	16.0	30.4	3.5	11	8×8.8	8.0	2.5	2.5	13.0	5.0

Service tee

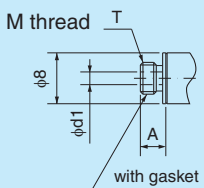
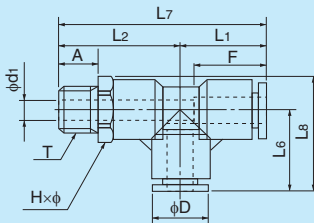

●Millimeter size type

Product number	Applicable tubing outer diameter (mm)	T Thread size (R,M)	L1 (mm)	L2 (mm)	L6 (mm)	L7 (mm)	L8 (mm)	A (mm)	F Tubing insertion length (mm)	H×φ Width across flat (mm)	D (mm)	d1 (mm)	Min. inner diameter (mm)	Effective sectional area (mm ²)	Weight (g)
EST4-M5-C1S	4	M5×0.8	17.7	20.2	17.7	38.0	23.2	4.0	14	10.0×11.0	10.0	2.0	2.0	3.0	8.0
EST4-R1/8-C1S	4	R1/8	17.7	22.7	17.7	40.4	23.2	8.0	14	10.0×11.0	10.0	5.0	3.0	4.0	10.0
EST6-M5-C1S	6	M5×0.8	18.9	22.7	18.9	41.6	25.4	4.0	15	12.0×13.0	13.0	2.0	2.0	3.5	12.0
EST6-R1/8-C1S	6	R1/8	18.9	25.2	18.9	44.1	25.4	8.0	15	12.0×13.0	13.0	5.0	4.5	12.0	14.0
EST6-R1/4-C1S	6	R1/4	18.9	29.2	18.9	48.1	26.6	11.0	15	14.0×15.4	13.0	7.0	4.5	12.0	21.0
EST8-R1/8-C1S	8	R1/8	21.1	27.2	21.1	48.3	28.8	8.0	16	14.0×15.4	15.0	6.5	6.5	18.5	18.0
EST8-R1/4-C1S	8	R1/4	21.1	31.2	21.1	52.3	28.8	12.0	16	14.0×15.4	15.0	6.5	6.5	23.0	24.0
EST10-R1/4-C1S	10	R1/4	25.0	37.2	25.0	62.2	34.3	12.0	19	17.0×18.5	18.0	8.0	8.0	34.5	34.0
EST10-R3/8-C1S	10	R3/8	25.0	37.2	25.0	62.2	34.3	14.0	19	17.0×18.5	18.0	9.0	8.0	37.0	40.0
EST12-R3/8-C1S	12	R3/8	26.7	38.7	26.7	65.4	37.2	14.0	20	19.0×21.0	20.5	10.0	10	43.0	48.0
EST12-R1/2-C1S	12	R1/2	26.7	41.7	26.7	68.4	38.7	16.0	20	22.0×24.0	20.5	12.0	9.5	43.0	65.0

*Made to order

Tubing

Clean tubing

Processed tubing

PushOne fitting

QuickSeal fitting

Clean fitting/ Chemifit

Bamboo-shoot fitting

Control switch/ Detachable series

Jig/Tool/ Accessory

Technical information

Reference

Y joint



●Millimeter size type

Product number	Applicable tubing outer diameter (mm)	T Thread size (R,M)	L (mm)	L ₁₁ (mm)	A (mm)	F Tubing insertion length (mm)	H×φ Width across flat (mm)	P ₃ (mm)	P ₄ (mm)	W (mm)	D (mm)	d ₁ (mm)	d ₂ (mm)	Min. inner diameter (mm)	Effective sectional area (mm ²)	Weight (g)
EY3-M5-C1S	3	M5×0.8	26.2	13.3	3.5	11	7.0×7.7	10.9	7.0	6.0	6.3	2.5	2.0	1.5	—	—
EY4-M5-C1S	4	M5×0.8	38.4	21.0	4.0	14	10.0×11.0	13.9	11.0	9.7	10.0	2.0	3.2	2.0	2.0	9.0
EY4-R1/8-C1S	4	R1/8	40.9	21.0	8.0	14	10.0×11.0	13.9	11.0	9.7	10.0	5.0	3.2	3.5	3.5	11.0
EY6-M5-C1S	6	M5×0.8	41.7	25.2	4.0	15	12.0×13.0	15.2	12.2	12.5	13.0	2.0	4.2	2.0	2.5	12.0
EY6-R1/8-C1S	6	R1/8	44.2	25.2	8.0	15	12.0×13.0	15.2	12.2	12.5	13.0	5.0	4.2	4.5	9.0	15.0
EY6-R1/4-C1S	6	R1/4	48.2	25.2	11.0	15	14.0×15.4	15.2	12.2	12.5	13.0	7.0	4.2	4.5	9.0	22.0
EY8-R1/8-C1S	8	R1/8	48.3	29.2	8.0	16	14.0×15.4	16.8	14.2	14.5	15.0	6.5	4.2	6.5	17.5	20.0
EY8-R1/4-C1S	8	R1/4	52.3	29.2	12.0	16	14.0×15.4	16.8	14.2	14.5	15.0	6.5	4.2	6.5	20.0	25.0
EY10-R1/4-C1S	10	R1/4	60.2	35.5	12.0	19	17.0×18.5	18.7	17.5	17.5	18.0	8.0	4.2	8.0	27.5	33.0
EY10-R3/8-C1S	10	R3/8	60.2	35.5	14.0	19	17.0×18.5	18.7	17.5	17.5	18.0	9.0	4.2	8.0	28.0	41.0
EY12-R3/8-C1S	12	R3/8	64.2	40.5	14.0	20	19.0×21.0	20.7	20.0	20.0	20.5	10.0	4.2	10.0	40.0	52.0
EY12-R1/2-C1S	12	R1/2	67.2	40.5	16.0	20	22.0×24.0	20.7	20.0	20.0	20.5	12.0	4.2	9.5	40.0	70.0

*Made to order

●Inch size type

Product number	Applicable tubing outer diameter (inch)	T Thread size (M)	L (mm)	L ₁₁ (mm)	A (mm)	F Tubing insertion length (mm)	H×φ Width across flat (mm)	P ₃ (mm)	P ₄ (mm)	W (mm)	D (mm)	d ₁ (mm)	d ₂ (mm)	Min. inner diameter (mm)	Effective sectional area (mm ²)	Weight (g)
EY1/8-M5-C1S	1/8	M5×0.8	26.4	17.0	3.5	11	8.0×8.8	11.7	9.0	8.0	8.0	2.5	3.2	2.5	—	—

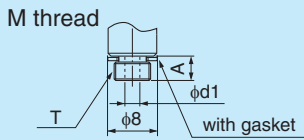
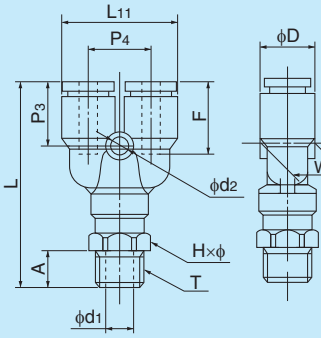

Panel touch connector

●Millimeter size type

Product number	Applicable tubing outer diameter (mm)	L (mm)	F Tubing insertion length (mm)	H ₄ (mm)	T ₁ Recommended panel hole diameter (mm)	t Max. panel thickness (mm)	Washer outer diameter (mm)	Washer thickness (mm)	Min. inner diameter (mm)	Effective sectional area (mm ²)	Weight (g)
EPC3-C1S	3	24.8	11	12.0	9.0	4.5	15.0	1.6	2.0	2.5	—

●Inch size type

Product number	Applicable tubing outer diameter (inch)	L (mm)	F Tubing insertion length (mm)	H ₄ (mm)	T ₁ Recommended panel hole diameter (mm)	t Max. panel thickness (mm)	Washer outer diameter (mm)	Washer thickness (mm)	Min. inner diameter (mm)	Effective sectional area (mm ²)	Weight (g)
EPC1/8-C1S	1/8	26.1	11	14.0	11.0	5.5	18.0	1.6	2.5	—	—

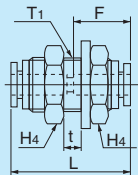

Tubing
Clean tubing
Processed tubing
Push One fitting
Quick Seal fitting
Clean fitting/ Chemifit
Bamboo-shoot fitting
Control switch/ Detachable series
Jig/Tool/ Accessory
Technical information
Reference

Reference

Technical
information

Jig/Tool/
Accessory

Control switch/
Detachable
series

Bambo-
shoot fitting

Clean fitting/
Chemifit

QuickSeal
fitting

PushOne
fitting

Processed
tubing

Clean
tubing

Tubing

Chemifit™ CSE Series

Threaded fitting for clean air, pure water and chemical liquids

Features

- **SUS316 threaded fitting**
2-piece assembly, consisting of nut and body, which utilizes Nitta's proprietary mechanism.
- **Highly improved workability for attaching and detaching a tubing**
Fitting body and insertion part have an integrated construction. The assembly nut has a built-in sleeve. Both the fitting body and the assembly nut are reusable.
- **Uniform workability for connecting tubing**
Tubing connection is completed when the assembly nut reaches the fitting body. No need for torque control or special tools.
- **No rotation of tubing when the tubing is attached**
A sleeve inside the assembly nut can rotate. Hence the inserted does not rotate with it.
- **Made in oil-free process**
Assembled after cleaning each part in a clean room.
- **High sealing performance**
Nitta's original sealing mechanism achieves high durability against degradation of sealing performance due to cold-hot cycle.
- **No need for additional tightening of nut**
Construction with less stress relaxation ensures high sealing performance for a long period of time and the nut does not need to be tightened at maintenance.
- **Highly smooth inner surface and R sphere surface processing on elbow crossing**
The surface roughness is below Ra3.2. The corner of the elbow is sphere surface processed, which reduces liquid and detergent remnants.
- **Silver plated thread inside assembly nut**
Prevents the body and assembly nuts from seizing when the tubing is tightened.

Cross-sectional structure diagram

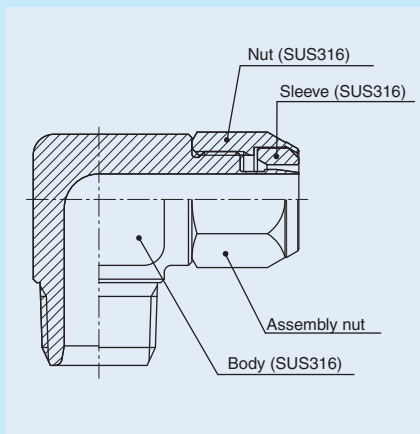

Sealing mechanism

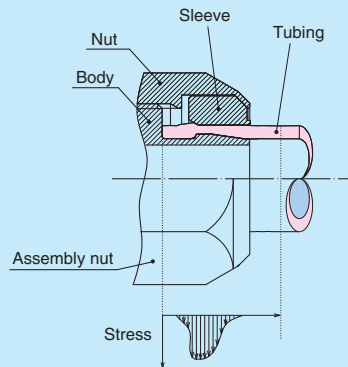

Nitta's original sealing mechanism achieves high durability against degradation of sealing performance due to cold-hot cycle. The mechanism does not cause stress relaxation, ensuring sealing performance for a long period of time. Also, the nut does not need to be tightened at maintenance.

Product number example

CSE - C 6x4 - R1/4

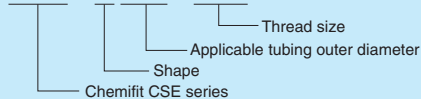

Operating fluid, working temperature range

Operating fluid	Working temperature range
Air (clean air)	-65°C~+260°C
Water (pure water)	0°C~+100°C

☞ Contact us for various chemical liquids.

☞ See "Combination List of Tubing and Fitting" on page 8.

Pressure condition

Maximum working pressure: 5.0MPa
Negative pressure performance:
-101.294kPa

Handling instructions

⚠ **Caution:** When the working conditions of tubes and fittings differ, use them under the lower specified conditions.

⚠ **Caution:** When water is used as the operating fluid, do not allow it to freeze.

⚠ **Caution:** Do not bend the pipe sharply near the tubing insertion port of the fitting. Keep the tubing straight for twice as long as the tubing diameter from the insertion port.

☞ See page 34 for the common handling instructions for fittings.

Distinction of millimeter/inch sizes

Assembly nut

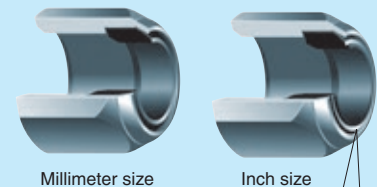

The inch size type has a boss at the sleeve end to distinguish from millimeter size type.

Reference

Instruction manual.....P.178
Chemical resistance specification table...P.198
Effective sectional areaP.168
Negative-pressure performance list...P.169

Applicable tubing

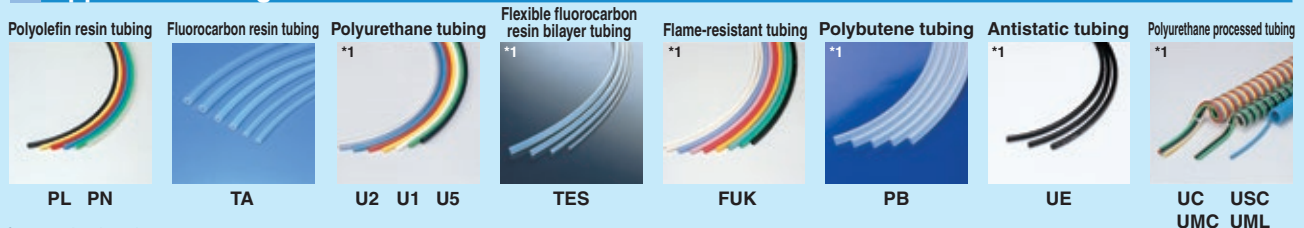

Clean, Antistatic tubing



ES

(*1) Combinatory use of U2, U1, U5, TES, FUK, PB, UE or polyurethane processed tubing and Chemifit CSE series mixes general and clean type performances.

When using them together in a clean environment, be aware of how this could lower the cleanliness level.

Chemifit™ CSE Series

Shape list



Tubing

Clean tubing

Processed tubing

PushOne fitting

QuickSeal fitting

Clean fitting/
Chemifit

Bamboo-shoot fitting

Control switch/
Detachable series

Jig/Tool/
Accessory

Technical information

Reference

Oil-free processing, Clean wrapping and packaging

- Ultrasonic cleaning with no oil or fat used for assembling in a clean room.

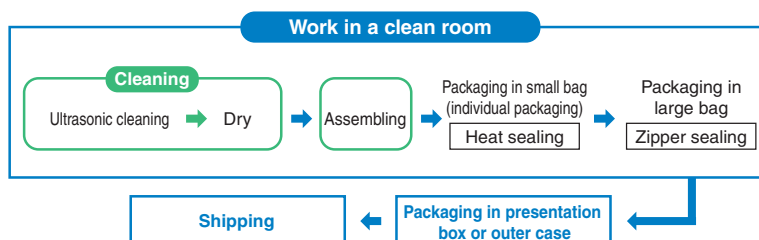

- High-barrier sheet packaging available

What is high-barrier sheet packaging?

In order to maintain the cleanliness of our products, no space for oxygen, water, or corrosive gas is allowed inside the package and a packaging bag with a high gas barrier is needed for protecting the content from these gases. To meet this requirement, Nitta provides high-barrier bags with a high gas barrier performance also for nitrogen sealing or atmospheric sealing.



- The packaging bags that Nitta uses have the highest gas barrier performance among clear bags.
- The bags do not contain halogen, etc., for safe burning.

Connector

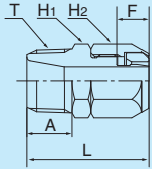

●Millimeter size type

Product number	Applicable tubing outer/inner diameters (mm)	T Thread size (R)	L (mm)	A (mm)	F Tubing insertion length (mm)	H ₁ Width across flat (mm)	H ₂ Width across flat (mm)	Min. inner diameter (mm)	Effective sectional area (mm ²)	Weight (g)
CSE-C4x2-R1/8	4x2	R1/8	23.0	8.0	5.5	10.0	10.0	1.5	1.7	11.0
CSE-C4x2-R1/4	4x2	R1/4	26.0	11.0	5.5	14.0	10.0	1.5	1.7	19.0
CSE-C6x4-R1/8	6x4	R1/8	25.5	8.0	7	12.0	12.0	3.5	9.0	16.0
CSE-C6x4-R1/4	6x4	R1/4	28.5	11.0	7	14.0	12.0	3.5	9.0	23.0
CSE-C6x4-R3/8	6x4	R3/8	29.5	12.0	7	17.0	12.0	3.5	9.0	33.0
CSE-C8x5-R1/8	8x5	R1/8	27.0	8.0	7.5	14.0	14.0	4.5	15.0	22.0
CSE-C8x5-R1/4	8x5	R1/4	30.0	11.0	7.5	14.0	14.0	4.5	15.5	26.0
CSE-C8x5-R3/8	8x5	R3/8	31.0	12.0	7.5	17.0	14.0	4.5	15.5	36.0
CSE-C8x6-R1/8	8x6	R1/8	27.0	8.0	7.5	14.0	14.0	5.5	23.0	21.0
CSE-C8x6-R1/4	8x6	R1/4	30.0	11.0	7.5	14.0	14.0	5.5	23.5	25.0
CSE-C8x6-R3/8	8x6	R3/8	31.0	12.0	7.5	17.0	14.0	5.5	23.5	35.0
CSE-C8x6-R1/2	8x6	R1/2	34.0	15.0	7.5	22.0	14.0	5.5	23.5	54.0
CSE-C10x6.5-R1/4	10x6.5	R1/4	31.5	11.0	8.5	17.0	17.0	6.0	27.5	36.0
CSE-C10x8-R1/4	10x8	R1/4	31.5	11.0	8.5	17.0	17.0	7.5	42.5	34.0
CSE-C10x8-R3/8	10x8	R3/8	32.5	12.0	8.5	17.0	17.0	7.5	43.5	40.0
CSE-C10x8-R1/2	10x8	R1/2	35.5	15.0	8.5	22.0	17.0	7.5	43.5	58.0
CSE-C12x8-R1/4	12x8	R1/4	33.5	11.0	10	17.0	19.0	7.5	42.5	42.0
CSE-C12x9-R1/4	12x9	R1/4	33.5	11.0	10	17.0	19.0	8.0	48.5	40.0
CSE-C12x9-R3/8	12x9	R3/8	34.5	12.0	10	17.0	19.0	8.5	53.0	46.0
CSE-C12x9-R1/2	12x9	R1/2	37.5	15.0	10	22.0	19.0	8.5	54.0	65.0
CSE-C12x10-R1/4	12x10	R1/4	33.5	11.0	10	17.0	19.0	8.0	49.5	39.0
CSE-C12x10-R3/8	12x10	R3/8	34.5	12.0	10	17.0	19.0	9.5	67.0	44.0
CSE-C12x10-R1/2	12x10	R1/2	37.5	15.0	10	22.0	19.0	9.5	68.5	63.0
CSE-C19x16-R1/2	19x16	R1/2	42.3	15.0	12.3	27.0	27.0	12.0	-	100.0
CSE-C19x16-R3/4	19x16	R3/4	44.3	17.0	12.3	29.0	27.0	15.0	-	119.0

*Made to order

●Inch size type

Product number	Applicable tubing outer/inner diameters (mm)	T Thread size (R)	L (mm)	A (mm)	F Tubing insertion length (mm)	H ₁ Width across flat (mm)	H ₂ Width across flat (mm)	Min. inner diameter (mm)	Effective sectional area (mm ²)	Weight (g)
CSE-C1/4-R1/8	6.35x4.57	R1/8	25.5	8.0	7	12.0	12.0	4.0	12.5	16.0
CSE-C1/4-R1/4	6.35x4.57	R1/4	28.5	11.0	7	14.0	12.0	4.0	12.5	22.0
CSE-C1/4-R3/8	6.35x4.57	R3/8	29.5	12.0	7	17.0	12.0	4.0	12.5	32.0
CSE-C3/8-R1/4	9.53x6.99	R1/4	32.0	11.0	9	17.0	17.0	6.5	32.0	36.0
CSE-C3/8-R3/8	9.53x6.99	R3/8	33.0	12.0	9	17.0	17.0	6.5	33.0	42.0
CSE-C3/8-R1/2	9.53x6.99	R1/2	36.0	15.0	9	22.0	17.0	6.5	32.5	62.0
CSE-C1/2-R1/4	12.70x9.56	R1/4	35.0	11.0	10.5	19.0	22.0	8.0	49.5	57.0
CSE-C1/2-R3/8	12.70x9.56	R3/8	36.0	12.0	10.5	19.0	22.0	9.0	61.0	63.0
CSE-C1/2-R1/2	12.70x9.56	R1/2	39.0	15.0	10.5	22.0	22.0	9.0	61.0	81.0

*Made to order

Internal connector

●Millimeter size type

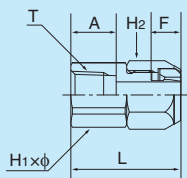

Product number	Applicable tubing outer/inner diameters (mm)	T Thread size (RC)	L (mm)	A (mm)	F Tubing insertion length (mm)	H ₂ Width across flat (mm)	H ₁ ×φ Width across flat (mm)	Min. inner diameter (mm)	Effective sectional area (mm ²)	Weight (g)
CSE-FC6x4-R1/8	6x4	RC1/8	24.5	8.7	7	12.0	14.0x15.4	3.5	9.0	20.0
CSE-FC8x6-R1/4	8x6	RC1/4	30.0	13.0	7.5	14.0	17.0x18.5	5.5	21.5	33.0
CSE-FC10x8-R1/4	10x8	RC1/4	31.5	13.0	8.5	17.0	17.0x18.5	7.5	29.0	39.0

Tubing
Clean tubing
Processed tubing
PushOne fitting
QuickSeal fitting
Clean fitting/ Chemifit
Bamboo-shoot fitting
Control switch/ Detachable series
Jig/Tool/ Accessory
Technical information
Reference

90 degree elbow

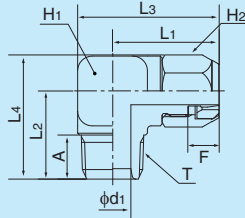

●Millimeter size type

Product number	Applicable tubing outer/inner diameters (mm)	T Thread size (R)	L1 (mm)	L2 (mm)	L3 (mm)	L4 (mm)	A (mm)	F Tubing insertion length (mm)	H1 Width across flat (mm)	H2 Width across flat (mm)	d1 (mm)	Min. inner diameter (mm)	Effective sectional area (mm ²)	Weight (g)
CSE-L6×4-R1/8	6×4	R1/8	23.5	17.0	30.5	24.0	8	7	14.0	12.0	6	3.5	8.5	33.0
CSE-L6×4-R1/4	6×4	R1/4	23.5	20.0	30.5	27.0	11	7	14.0	12.0	8	3.5	8.5	35.0
CSE-L6×4-R3/8	6×4	R3/8	26.0	24.0	35.5	33.5	12	7	19.0	12.0	10	3.5	8.0	72.0
CSE-L8×5-R1/4	8×5	R1/4	25.0	20.0	32.0	28.1	11	7.5	14.0	14.0	8	4.5	-	42.0
CSE-L8×6-R1/8	8×6	R1/8	25.0	18.0	32.0	26.1	8	7.5	14.0	14.0	6	5.5	19.0	37.0
CSE-L8×6-R1/4	8×6	R1/4	25.0	20.0	32.0	28.1	11	7.5	14.0	14.0	8	5.5	20.0	38.0
CSE-L8×6-R3/8	8×6	R3/8	27.5	24.0	37.0	33.5	12	7.5	19.0	14.0	10	5.5	20.5	74.0
CSE-L8×6-R1/2	8×6	R1/2	29.0	27.0	40.0	38.0	15	7.5	22.0	14.0	12	5.5	20.5	98.0
CSE-L10×8-R1/4	10×8	R1/4	29.0	23.0	38.5	32.8	11	8.5	19.0	17.0	8	7.5	35.0	77.0
CSE-L10×8-R3/8	10×8	R3/8	29.0	24.0	38.5	33.8	12	8.5	19.0	17.0	10	7.5	37.0	79.0
CSE-L10×8-R1/2	10×8	R1/2	30.5	27.0	41.5	38.0	15	8.5	22.0	17.0	12	7.5	-	116.0
CSE-L12×8-R1/4	12×8	R1/4	31.0	23.0	40.5	34.0	11	10	19.0	19.0	8	7.5	34.0	85.0
CSE-L12×8-R1/2	12×8	R1/2	32.5	27.0	43.5	38.0	15	10	22.0	19.0	12	7.5	38.0	110.0
CSE-L12×9-R1/4	12×9	R1/4	31.0	23.0	40.5	34.0	11	10	19.0	19.0	8	8	40.5	83.0
CSE-L12×9-R3/8	12×9	R3/8	31.0	24.0	40.5	35.0	12	10	19.0	19.0	10	8.5	44.0	85.0
CSE-L12×9-R1/2	12×9	R1/2	32.5	27.0	43.5	38.0	15	10	22.0	19.0	12	8.5	48.5	107.0
CSE-L12×10-R1/4	12×10	R1/4	31.0	23.0	40.5	34.0	11	10	19.0	19.0	8	8	47.5	80.0
CSE-L12×10-R3/8	12×10	R3/8	31.0	24.0	40.5	35.0	12	10	19.0	19.0	10	9.5	54.0	83.0
CSE-L12×10-R1/2	12×10	R1/2	32.5	27.0	43.5	38.0	15	10	22.0	19.0	12	9.5	56.0	106.0
CSE-L19×16-R3/8	19×16	R3/8	37.3	27.5	50.3	43.1	12	12.3	26.0	27.0	10	10	-	192.0
CSE-L19×16-R1/2	19×16	R1/2	37.3	30.5	50.3	46.1	15	12.3	26.0	27.0	12	12	-	201.0
CSE-L19×16-R3/4	19×16	R3/4	38.8	34.0	53.3	49.6	17	12.3	29.0	27.0	15	15	-	267.0

*Made to order

●Inch size type

Product number	Applicable tubing outer/inner diameters (mm)	T Thread size (R)	L1 (mm)	L2 (mm)	L3 (mm)	L4 (mm)	A (mm)	F Tubing insertion length (mm)	H1 Width across flat (mm)	H2 Width across flat (mm)	d1 (mm)	Min. inner diameter (mm)	Effective sectional area (mm ²)	Weight (g)
CSE-L1/4-R1/8	6.35×4.57	R1/8	23.5	17.0	30.5	24.0	8	7	14.0	12.0	6.0	4.0	10.5	37.0
CSE-L1/4-R1/4	6.35×4.57	R1/4	23.5	20.0	30.5	27.0	11	7	14.0	12.0	8.0	4.0	11.0	38.0
CSE-L1/4-R3/8	6.35×4.57	R3/8	26.0	24.0	35.5	33.5	12	7	19.0	12.0	10.0	4.0	11.0	81.0
CSE-L3/8-R1/4	9.53×6.99	R1/4	29.5	23.0	39.0	33.0	11	9	19.0	17.0	8.0	6.5	27.5	90.0
CSE-L3/8-R3/8	9.53×6.99	R3/8	29.5	24.0	39.0	34.0	12	9	19.0	17.0	10.0	6.5	28.5	91.0
CSE-L3/8-R1/2	9.53×6.99	R1/2	31.0	27.0	42.0	38.0	15	9	22.0	17.0	12.0	6.5	29.5	123.0
CSE-L1/2-R1/4	12.70×9.56	R1/4	31.5	26.0	41.0	38.7	11	10.5	19.0	22.0	8.0	8.0	44.0	111.0
CSE-L1/2-R3/8	12.70×9.56	R3/8	31.5	27.0	41.0	39.7	12	10.5	19.0	22.0	10.0	9.0	50.5	112.0
CSE-L1/2-R1/2	12.70×9.56	R1/2	33.0	27.5	44.0	40.2	15	10.5	22.0	22.0	12.0	9.0	51.5	135.0

*Made to order

Tee

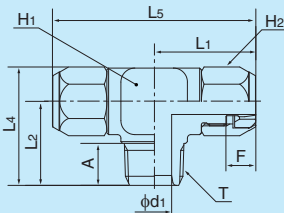

●Millimeter size type

Product number	Applicable tubing outer/inner diameters (mm)	T Thread size (R)	L1 (mm)	L2 (mm)	L4 (mm)	L5 (mm)	A (mm)	F Tubing insertion length (mm)	H1 Width across flat (mm)	H2 Width across flat (mm)	d1 (mm)	Min. inner diameter (mm)	Effective sectional area (mm ²)	Weight (g)
CSE-T6×4-R1/8	6×4	R1/8	23.5	17.0	24.0	47.0	8.0	7	14.0	12.0	6.0	3.5	-	48.0
CSE-T6×4-R1/4	6×4	R1/4	23.5	20.0	27.0	47.0	11.0	7	14.0	12.0	8.0	3.5	-	50.0
CSE-T6×4-R3/8	6×4	R3/8	26.0	24.0	33.5	52.0	12.0	7	19.0	12.0	10.0	3.5	-	94.0
CSE-T8×6-R1/8	8×6	R1/8	25.0	18.0	26.1	50.0	8.0	7.5	14.0	14.0	6.0	5.5	-	54.0
CSE-T8×6-R1/4	8×6	R1/4	25.0	20.0	28.1	50.0	11.0	7.5	14.0	14.0	8.0	5.5	-	56.0
CSE-T8×6-R3/8	8×6	R3/8	27.5	24.0	33.5	55.0	12.0	7.5	19.0	14.0	10.0	5.5	20.5	102.0
CSE-T8×6-R1/2	8×6	R1/2	29.0	27.0	38.0	58.0	15.0	7.5	22.0	14.0	12.0	5.5	-	127.0
CSE-T10×8-R1/4	10×8	R1/4	29.0	23.0	32.8	58.0	11.0	8.5	19.0	17.0	8.0	7.5	34.0	109.0
CSE-T10×8-R3/8	10×8	R3/8	29.0	24.0	33.8	58.0	12.0	8.5	19.0	17.0	10.0	7.5	-	110.0
CSE-T10×8-R1/2	10×8	R1/2	30.5	27.0	38.0	61.0	15.0	8.5	22.0	17.0	12.0	7.5	-	138.0
CSE-T12×9-R1/4	12×9	R1/4	31.0	23.0	34.0	62.0	11.0	10	19.0	19.0	8.0	8.0	-	119.0
CSE-T12×9-R3/8	12×9	R3/8	31.0	24.0	35.0	62.0	12.0	10	19.0	19.0	10.0	8.5	-	121.0
CSE-T12×9-R1/2	12×9	R1/2	32.5	27.0	38.0	65.0	15.0	10	22.0	19.0	12.0	8.5	-	149.0
CSE-T12×10-R1/4	12×10	R1/4	31.0	23.0	34.0	62.0	11.0	10	19.0	19.0	8.0	8.0	-	115.0
CSE-T12×10-R3/8	12×10	R3/8	31.0	24.0	35.0	62.0	12.0	10	19.0	19.0	10.0	9.5	-	117.0
CSE-T12×10-R1/2	12×10	R1/2	32.5	27.0	38.0	65.0	15.0	10	22.0	19.0	12.0	9.5	-	145.0

*Made to order

●Inch size type

Product number	Applicable tubing outer/inner diameters (mm)	T Thread size (R)	L1 (mm)	L2 (mm)	L4 (mm)	L5 (mm)	A (mm)	F Tubing insertion length (mm)	H1 Width across flat (mm)	H2 Width across flat (mm)	d1 (mm)	Min. inner diameter (mm)	Effective sectional area (mm ²)	Weight (g)
CSE-T1/4-R1/8	6.35×4.57	R1/8	23.5	17.0	24.0	47.0	8.0	7	14.0	12.0	6.0	4.0	-	47.0
CSE-T1/4-R1/4	6.35×4.57	R1/4	23.5	20.0	27.0	47.0	11.0	7	14.0	12.0	8.0	4.0	-	49.0
CSE-T1/4-R3/8	6.35×4.57	R3/8	26.0	24.0	33.5	52.0	12.0	7	19.0	12.0	10.0	4.0	-	93.0
CSE-T3/8-R1/4	9.53×6.99	R1/4	29.5	23.0	33.0	59.0	11.0	9	19.0	17.0	8.0	6.5	-	112.0
CSE-T3/8-R3/8	9.53×6.99	R3/8	29.5	24.0	34.0	59.0	12.0	9	19.0	17.0	10.0	6.5	-	114.0
CSE-T3/8-R1/2	9.53×6.99	R1/2	31.0	27.0	38.0	62.0	15.0	9	22.0	17.0	12.0	6.5	-	142.0
CSE-T1/2-R1/4	12.70×9.56	R1/4	31.5	26.0	38.7	63.0	11.0	10.5	19.0	22.0	8.0	8.0	-	149.0
CSE-T1/2-R3/8	12.70×9.56	R3/8	31.5	27.0	39.7	63.0	12.0	10.5	19.0	22.0	10.0	9.0	-	151.0
CSE-T1/2-R1/2	12.70×9.56	R1/2	33.0	27.5	40.2	66.0	15.0	10.5	22.0	22.0	12.0	9.0	-	175.0

*Made to order

Tubing

Clean tubing

Processed tubing

PushOne fitting

QuickSeal fitting

Clean fitting/ Chemifit

Bamboo-shoot fitting

Control switch/ Detachable series

Jig/Tool/ Accessory

Technical information

Reference

Service tee



●Millimeter size type

Product number	Applicable tubing outer/inner diameters (mm)	T Thread size (R)	L ₁ (mm)	L ₂ (mm)	L ₃ (mm)	L ₆ (mm)	A (mm)	F Tubing insertion length (mm)	H ₁ Width across flat (mm)	H ₂ Width across flat (mm)	Min. inner diameter (mm)	Effective sectional area (mm ²)	Weight (g)
* CSE-ST6x4-R1/8	6x4	R1/8	23.5	17.0	30.5	40.5	8	7	14.0	12.0	3.5	-	50.0
* CSE-ST6x4-R1/4	6x4	R1/4	23.5	20.5	30.5	44.0	11	7	14.0	12.0	3.5	7.0	56.0
* CSE-ST8x6-R1/4	8x6	R1/4	25.0	20.0	33.1	45.0	11	7.5	14.0	14.0	5.5	-	59.0
* CSE-ST10x8-R3/8	10x8	R3/8	29.0	24.0	38.8	53.0	12	8.5	19.0	17.0	7.5	-	115.0
* CSE-ST12x9-R1/2	12x9	R1/2	32.5	30.0	45.5	62.5	15	10	26.0	19.0	8.5	-	221.0
* CSE-ST12x10-R1/2	12x10	R1/2	32.5	30.0	45.5	62.5	15	10	26.0	19.0	9.5	-	216.0

*Made to order

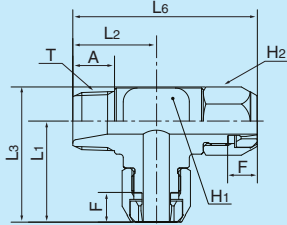

Union connector



●Millimeter size type

Product number	Applicable tubing outer/inner diameters (mm)	L (mm)	F Tubing insertion length (mm)	H ₁ Width across flat (mm)	H ₂ Width across flat (mm)	Min. inner diameter (mm)	Effective sectional area (mm ²)	Weight (g)
CSE-UC6x4	6x4	32.0	7	12.0	12.0	3.5	8.5	23.0
* CSE-UC8x5	8x5	36.0	7.5	14.0	14.0	4.5	-	35.0
CSE-UC8x6	8x6	36.0	7.5	14.0	14.0	5.5	21.5	34.0
CSE-UC10x8	10x8	40.0	8.5	17.0	17.0	7.5	39.5	54.0
CSE-UC12x9	12x9	45.0	10	19.0	19.0	8.5	47.0	73.0
* CSE-UC12x10	12x10	45.0	10	19.0	19.0	9.5	63.0	70.0

*Made to order

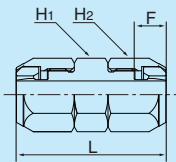

●Inch size type

Product number	Applicable tubing outer/inner diameters (mm)	L (mm)	F Tubing insertion length (mm)	H ₁ Width across flat (mm)	H ₂ Width across flat (mm)	Min. inner diameter (mm)	Effective sectional area (mm ²)	Weight (g)
CSE-UC1/4	6.35x4.57	32.0	7	12.0	12.0	4	11.0	23.0
CSE-UC3/8	9.53x6.99	41.0	9.0	17.0	17.0	6.5	30.0	57.0
CSE-UC1/2	12.70x9.56	48.0	10.5	19.0	22.0	9	57.5	102.0

90 degree union elbow



●Millimeter size type

Product number	Applicable tubing outer/inner diameters (mm)	L ₁ (mm)	L ₃ (mm)	F Tubing insertion length (mm)	H ₁ Width across flat (mm)	H ₂ Width across flat (mm)	Min. inner diameter (mm)	Effective sectional area (mm ²)	Weight (g)
CSE-UL6x4	6x4	23.5	30.5	7	14.0	12.0	3.5	7.0	43.0
CSE-UL8x6	8x6	25.0	33.1	7.5	14.0	14.0	5.5	17.5	49.0
CSE-UL10x8	10x8	29.0	38.8	8.5	19.0	17.0	7.5	32.5	95.0
CSE-UL12x9	12x9	31.0	42.0	10	19.0	19.0	8.5	42.0	116.0
* CSE-UL12x10	12x10	31.0	42.0	10	19.0	19.0	9.5	-	106.0
* CSE-UL19x16	19x16	38.8	54.4	12.3	26.0	27.0	15.0	-	-

*Made to order

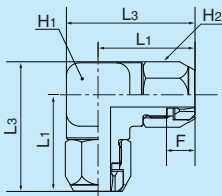

Tubing
Clean tubing
Processed tubing
PushOne fitting
QuickSeal fitting
Clean fitting/ Chemifit
Bamboo-shoot fitting
Control switch/ Detachable series
Jig/Tool/ Accessory
Technical information
Reference

Union tee



●Millimeter size type

Product number	Applicable tubing outer/inner diameters (mm)	L ₁ (mm)	L ₃ (mm)	L ₅ (mm)	F Tubing insertion length (mm)	H ₁ Width across flat (mm)	H ₂ Width across flat (mm)	Min. inner diameter (mm)	Effective sectional area (mm ²)	Weight (g)
CSE-UT6×4	6×4	23.5	30.5	47.0	7	14.0	12.0	3.5	7.0	59.0
CSE-UT8×5	8×5	25.0	33.1	50.0	7.5	14.0	14.0	4.5	11.5	72.0
CSE-UT8×6	8×6	25.0	33.1	50.0	7.5	14.0	14.0	5.5	16.5	68.0
CSE-UT10×8	10×8	29.0	38.8	58.0	8.5	19.0	17.0	7.5	31.5	127.0
CSE-UT12×9	12×9	31.0	42.0	62.0	10	19.0	19.0	8.5	-	140.0
CSE-UT12×10	12×10	31.0	42.0	62.0	10	19.0	19.0	9.5	-	133.0

*Made to order

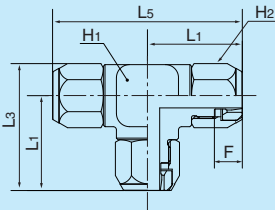

●Inch size type

Product number	Applicable tubing outer/inner diameters (mm)	L ₁ (mm)	L ₃ (mm)	L ₅ (mm)	F Tubing insertion length (mm)	H ₁ Width across flat (mm)	H ₂ Width across flat (mm)	Min. inner diameter (mm)	Effective sectional area (mm ²)	Weight (g)
CSE-UT1/4	6.35×4.57	23.5	30.5	47.0	7	14.0	12.0	4	-	55.0
CSE-UT3/8	9.53×6.99	29.5	39.5	59.0	9	19.0	17.0	6.5	-	129.0
CSE-UT1/2	12.70×9.56	33.0	45.7	66.0	10.5	22.0	22.0	9	45.5	204.0

*Made to order

Panel touch connector



●Millimeter size type

Product number	Applicable tubing outer/inner diameters (mm)	L (mm)	F Tubing insertion length (mm)	H ₂ Width across flat (mm)	H ₃ Width across flat (mm)	T Thread size (M)	t Max. panel thickness (mm)	Washer thickness (mm)	Washer outer diameter (mm)	H ₁ ×φ Width across flat (mm)	Min. inner diameter (mm)	Effective sectional area (mm ²)	Weight (g)
CSE-UCT6×4	6×4	45.0	7	12.0	21.0	M15×1	6.0	3	28	21.0×23.0	3.5	8.0	70.0
CSE-UCT8×5	8×5	48.0	7.5	14.0	22.0	M17×1	6.0	3	30	22.0×24.5	4.5	-	85.0
CSE-UCT8×6	8×6	48.0	7.5	14.0	22.0	M17×1	6.0	3	30	22.0×24.5	5.5	21.0	83.0
CSE-UCT10×8	10×8	51.0	8.5	17.0	26.0	M20×1	6.0	3	34	26.0×29.0	7.5	40.5	121.0
CSE-UCT12×9	12×9	54.5	10	19.0	27.0	M22×1	5.5	3	37	27.0×30.0	8.5	47.5	139.0
CSE-UCT12×10	12×10	54.5	10	19.0	27.0	M22×1	5.5	3	37	27.0×30.0	9.5	63.0	135.0

*Made to order

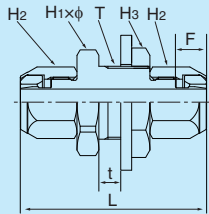

Assembly nut



●Millimeter size type

Product number	Applicable tubing outer diameter (mm)	L (mm)	H ₂ Width across flat (mm)	Weight (g)
CSAN4	4	11.0	10.0	4.0
CSAN6	6	12.5	12.0	6.0
CSAN8	8	14.0	14.0	8.5
CSAN10	10	15.5	17.0	14.0
CSAN12	12	17.5	19.0	18.5
CSAN19	19	22.5	27.0	37.5

*Made to order

●Inch size type

Product number	Applicable tubing outer diameter (inch)	L (mm)	H ₂ Width across flat (mm)	Weight (g)
CSAN1/4	1/4	12.5	12.0	6.0
CSAN3/8	3/8	15.5	17.0	14.5
CSAN1/2	1/2	19.0	22.0	29.0

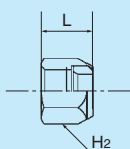

Tubing

Clean tubing

Processed tubing

PushOne fitting

QuickSeal fitting

Clean fitting/ Chemifit

Bamboo-shoot fitting

Control switch/ Detachable series

Jig/Tool/ Accessory

Technical information

Reference

Bushing

●Millimeter size type



Product number	T ₁ Thread size (RC)	T ₂ Thread size (R)	L (mm)	A ₁ (mm)	A ₂ (mm)	H×φ Width across flat (mm)	d ₁ (mm)	Weight (g)
3A0-4-6-CS	RC1/4	R3/8	29.0	14.0	13.0	17.0×18.5	9.0	—
3A0-6-8-CS	RC3/8	R1/2	34.5	18.0	13.5	22.0×24.5	11.0	—
3A0-8-12-CS	RC1/2	R3/4	40.0	20.0	17.5	30.0×33.0	11.0	—

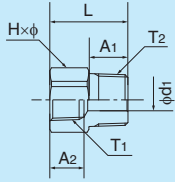

Socket

●Millimeter size type



Product number	T Thread size (RC)	L (mm)	A (mm)	H×φ Width across flat (mm)	d ₁ (mm)	Weight (g)
330-4-4-CS	RC1/4	30.0	13.0	17.0×18.5	9.0	—
330-6-6-CS	RC3/8	33.0	13.5	19.0×21.0	13.0	—
330-8-8-CS	RC1/2	39.5	17.5	24.0×26.5	17.0	—

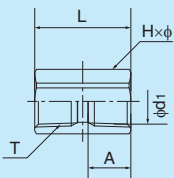

- Tubing
- Clean tubing
- Processed tubing
- PushOne fitting
- QuickSeal fitting
- Clean fitting/ Chemifit
- Bamboo-shoot fitting
- Control switch/ Detachable series
- Jig/Tool/ Accessory
- Technical information
- Reference

Reference

Technical information

Jig/Tool/
Accessory

Control switch/
Detachable
series

Bambo-
shoot fitting

Clean fitting/
Chemifit

QuickSeal
fitting

PushOne
fitting

Processed
tubing

Clean
tubing

Tubing

Chemifit™ CP Series

Threaded fitting for clean air, pure water and chemical liquids

Features

- Threaded fitting made of polypropylene resin
Lightweight.
- Made in oil-free process
Each part is cleaned in a clean room.
- Highly smooth inner surface
Smooth inner surface due to ejection forming.
- High performance, free of dust and contamination
Made of special polypropylene resin.
- Compliant with the MHLW Ministerial Notification No.201(2006),
MHW Ministerial Notification No.370(1959), Japan

Cross-sectional structure diagram

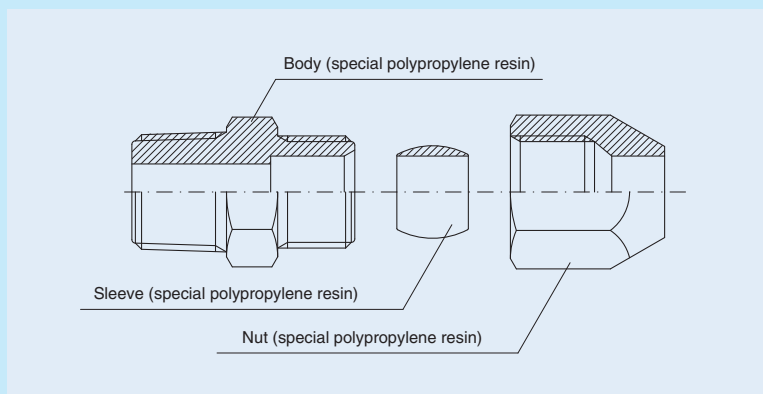

Product number example

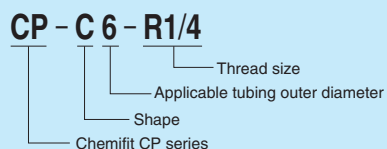

Distinction of millimeter/inch sizes

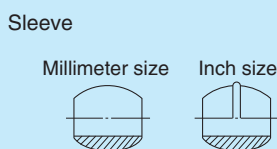

The millimeter and inch size types of the Chemifit CP series are distinguished by the outer shape of the sleeve.



Operating fluid, working temperature range

Operating fluid	Working temperature range
Air (clean air)	-20°C~+80°C
Water (pure water)	0°C~+80°C

☞ Contact us for various chemical liquids.

☞ See "Combination List of Tubing and Fitting" on page 8.

Pressure condition

Maximum working pressure: 0.4MPa(at20°C)
Negative pressure performance: -99.975kPa

Handling instructions

⚠ **Caution:** When the working conditions of tubes and fittings differ, use them under the lower specified conditions.

⚠ **Caution:** Use an insertion part (sold separately) to attach a flexible tubing.

⚠ **Caution:** Stress relaxation occurs more readily with resin thread than with metal thread. The relaxation is prominent at a high temperature. Tighten the thread periodically.

⚠ **Caution:** For use at a high temperature within the working temperature range, tighten the nut periodically. If the nut cannot be tightened further, cut the tubing end and insert the tubing again with a new sleeve.

⚠ **Caution:** When water is used as the operating fluid, do not allow it to freeze.

⚠ **Caution:** Do not bend the pipe sharply near the tubing insertion port (sleeve end) of the fitting. Keep the tubing straight for twice as long as the tubing diameter from the insertion port.

☞ See page 34 for the common handling instructions for fittings.

Applicable tubing

Polyolefin resin tubing Fluorocarbon resin tubing



PL PN

TA TP

(*1) Use an insertion part (sold separately) to attach a flexible tubing.

Reference

Instruction manualP.180
Chemical resistance
specification tableP.198
Effective sectional area ..P.168
Negative-pressure
performance listP.169

Chemifit™ CP Series

Shape list



Tubing

Clean tubing

Processed tubing

PushOne fitting

QuickSeal fitting

Clean fitting/ Chemifit

Bamboo-shoot fitting

Control switch/ Detachable series

Jig/Tool/ Accessory

Technical information

Reference

Relation between the working temperature and the maximum working pressure

The maximum working pressure varies with the working temperature (environmental temperature). For use at an abnormal temperature, always check the maximum working pressure change in the graph below and keep the pressure within the indicated range.

⚠ Caution: Using tubes at a pressure outside the range may cause accidents or damage, for which Nitta is not liable.

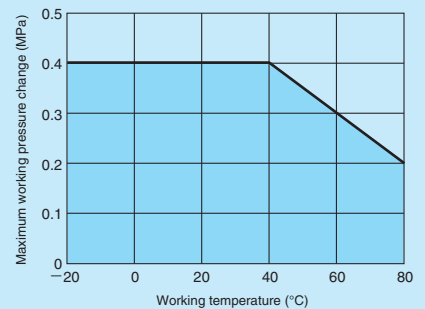

Oil-free processing, Clean wrapping and packaging

● Ultrasonic cleaning with no oil or fat used for assembling in a clean room.

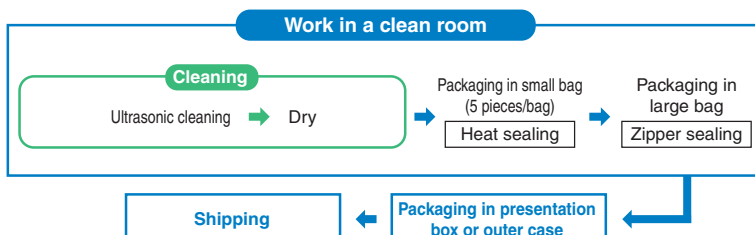

● High-barrier sheet packaging available

What is high-barrier sheet packaging?

In order to maintain the cleanliness of our products, no space for oxygen, water, or corrosive gas is allowed inside the package and a packaging bag with a high gas barrier is needed for protecting the content from these gases. To meet this requirement, Nitta provides high-barrier bags with a high gas barrier performance also for nitrogen sealing or atmospheric sealing.



- The packaging bags that Nitta uses have the highest gas barrier performance among clear bags.
- The bags do not contain halogen, etc., for safe burning.

Connector

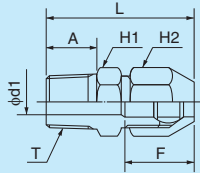

●Millimeter size type

Product number	Applicable tubing outer diameter (mm)	T Thread size (R)	L (mm)	A (mm)	F Tubing insertion length (mm)	H ₁ Width across flat (mm)	H ₂ Width across flat (mm)	d ₁ (mm)	Min. inner diameter (mm)	Effective sectional area (mm ²)	Weight (g)
CP-C4-R1/8	4	R1/8	29.8	8.0	17	12.0	12.0	4.3	2.8	3.5	2.0
CP-C6-R1/8	6	R1/8	37.1	12.0	19	14.0	14.0	5.0	5.0	11.0	3.0
CP-C6-R1/4	6	R1/4	37.1	12.0	19	14.0	14.0	5.0	5.0	11.0	3.0
CP-C8-R1/8	8	R1/8	42.5	9.0	22	16.5	16.5	6.0	6.0	24.5	5.0
CP-C8-R1/4	8	R1/4	45.0	12.0	22	16.5	16.5	6.0	6.0	24.5	5.0
CP-C10-R1/4	10	R1/4	46.8	12.0	29	18.5	19.0	8.0	8.0	37.0	6.0
CP-C10-R3/8	10	R3/8	48.6	13.5	29	18.5	19.0	8.0	8.0	37.0	7.0
CP-C12-R3/8	12	R3/8	57.7	13.5	29	24.0	21.5	9.9	9.9	54.0	11.0
CP-C12-R1/2	12	R1/2	59.9	15.5	29	24.0	21.5	9.9	9.9	54.0	13.0

●Inch size type

Product number	Applicable tubing outer diameter (inch)	T Thread size (R)	L (mm)	A (mm)	F Tubing insertion length (mm)	H ₁ Width across flat (mm)	H ₂ Width across flat (mm)	d ₁ (mm)	Min. inner diameter (mm)	Effective sectional area (mm ²)	Weight (g)
CP-C1/4-R1/8	1/4	R1/8	37.4	12.0	19	14.0	14.0	5.0	5.0	15.0	3.0
CP-C1/4-R1/4	1/4	R1/4	37.4	12.0	19	14.0	14.0	5.0	5.0	15.0	3.0
CP-C3/8-R1/4	3/8	R1/4	45.9	12.0	28	18.5	19.0	8.0	8.0	34.0	6.0
CP-C3/8-R3/8	3/8	R3/8	47.7	13.5	28	18.5	19.0	8.0	8.0	34.0	7.0
CP-C1/2-R3/8	1/2	R3/8	58.2	13.5	29	24.0	22.0	9.9	9.9	59.0	11.0
CP-C1/2-R1/2	1/2	R1/2	60.7	15.5	29	24.0	22.0	9.9	9.9	59.0	13.0

90 degree elbow

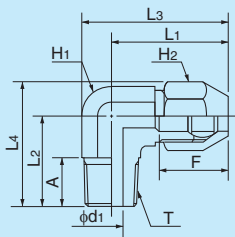

●Millimeter size type

Product number	Applicable tubing outer diameter (mm)	T Thread size (R)	L ₁ (mm)	L ₂ (mm)	L ₃ (mm)	L ₄ (mm)	A (mm)	F Tubing insertion length (mm)	H ₁ Width across flat (mm)	H ₂ Width across flat (mm)	d ₁ (mm)	Min. inner diameter (mm)	Effective sectional area (mm ²)	Weight (g)
CP-L4-R1/8	4	R1/8	26.8	21.0	32.6	27.9	8.0	17	10.0	12.0	4.0	2.8	3.0	3.0
CP-L6-R1/8	6	R1/8	29.1	23.0	36.0	31.1	12.0	19	12.0	14.0	5.0	5.0	10.0	4.0
CP-L6-R1/4	6	R1/4	29.1	23.0	36.0	31.1	12.0	19	12.0	14.0	5.0	5.0	10.0	4.0
CP-L8-R1/8	8	R1/8	37.0	24.0	43.9	33.5	9.0	22	12.0	16.5	6.0	6.0	19.5	6.0
CP-L8-R1/4	8	R1/4	37.0	27.0	43.9	36.5	12.5	22	12.0	16.5	6.0	6.0	19.5	6.0
CP-L10-R1/4	10	R1/4	41.8	27.0	51.3	37.9	12.0	29	16.5	19.0	8.0	8.0	30.0	9.0
CP-L10-R3/8	10	R3/8	41.8	27.0	51.3	37.9	13.5	29	16.5	19.0	8.0	8.0	30.0	10.0
CP-L12-R3/8	12	R3/8	45.7	27.0	56.3	39.4	13.7	29	18.5	21.5	9.9	9.9	46.0	12.0
CP-L12-R1/2	12	R1/2	45.7	27.0	56.3	39.4	16.0	29	18.5	21.5	9.9	9.9	46.0	14.0

●Inch size type

Product number	Applicable tubing outer diameter (inch)	T Thread size (R)	L ₁ (mm)	L ₂ (mm)	L ₃ (mm)	L ₄ (mm)	A (mm)	F Tubing insertion length (mm)	H ₁ Width across flat (mm)	H ₂ Width across flat (mm)	d ₁ (mm)	Min. inner diameter (mm)	Effective sectional area (mm ²)	Weight (g)
CP-L1/4-R1/8	1/4	R1/8	29.4	23.0	36.3	31.1	12.0	19	12.0	14.0	5.0	5.0	12.0	4.0
CP-L1/4-R1/4	1/4	R1/4	29.4	23.0	36.3	31.1	12.0	19	12.0	14.0	5.0	5.0	12.0	4.0
CP-L3/8-R1/4	3/8	R1/4	40.9	27.0	50.4	37.9	12.0	28	16.5	19.0	8.0	8.0	29.0	9.0
CP-L3/8-R3/8	3/8	R3/8	40.9	27.0	50.4	37.9	13.5	28	16.5	19.0	8.0	8.0	29.0	10.0
CP-L1/2-R3/8	1/2	R3/8	46.2	27.0	56.8	39.7	13.5	29	18.5	22.0	9.9	9.9	53.0	12.0
CP-L1/2-R1/2	1/2	R1/2	46.2	27.0	56.8	39.7	16.0	29	18.5	22.0	9.9	9.9	53.0	14.0

Tubing

Clean tubing

Processed tubing

PushOne fitting

QuickSeal fitting

Clean fitting/ Chemifit

Bamboo-shoot fitting

Control switch/ Detachable series

Jig/Tool/ Accessory

Technical information

Reference

Tee

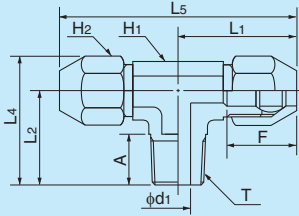

●Millimeter size type

Product number	Applicable tubing outer diameter (mm)	T Thread size (R)	L1 (mm)	L2 (mm)	L4 (mm)	L5 (mm)	A (mm)	F Tubing insertion length (mm)	H1 Width across flat (mm)	H2 Width across flat (mm)	d1 (mm)	Min. inner diameter (mm)	Effective sectional area (mm ²)	Weight (g)
CP-T4-R1/8	4	R1/8	26.8	18.0	24.9	53.7	8.0	17	10.0	12.0	2.8	2.8	3.0	4.0
CP-T6-R1/8	6	R1/8	29.2	22.0	30.1	58.5	12.0	19	12.0	14.0	5.0	5.0	10.0	5.0
CP-T6-R1/4	6	R1/4	29.2	22.0	30.1	58.5	12.0	19	12.0	14.0	5.0	5.0	10.0	5.0
CP-T8-R1/8	8	R1/8	35.0	20.5	30.0	69.9	10.0	22	9.5	16.5	6.0	6.0	19.5	6.0
CP-T8-R1/4	8	R1/4	35.0	24.0	33.5	69.9	13.0	22	9.5	16.5	6.0	6.0	19.5	6.0
CP-T10-R1/4	10	R1/4	44.5	28.5	39.4	89.0	12.0	29	12.0	19.0	8.0	8.0	30.0	9.0
CP-T10-R3/8	10	R3/8	44.5	29.0	39.9	89.0	13.5	29	12.0	19.0	8.0	8.0	30.0	10.0
CP-T12-R3/8	12	R3/8	50.1	31.0	43.4	100.2	13.5	29	13.5	21.5	9.9	9.9	46.0	12.0
CP-T12-R1/2	12	R1/2	50.1	33.0	45.4	100.2	15.5	29	13.5	21.5	9.9	9.9	46.0	14.0

●Inch size type

Product number	Applicable tubing outer diameter (inch)	T Thread size (R)	L1 (mm)	L2 (mm)	L4 (mm)	L5 (mm)	A (mm)	F Tubing insertion length (mm)	H1 Width across flat (mm)	H2 Width across flat (mm)	d1 (mm)	Min. inner diameter (mm)	Effective sectional area (mm ²)	Weight (g)
CP-T1/4-R1/8	1/4	R1/8	29.6	22.0	30.1	59.1	12.0	19	12.0	14.0	5.0	5.0	12.0	5.0
CP-T1/4-R1/4	1/4	R1/4	29.6	22.0	30.1	59.1	12.0	19	12.0	14.0	5.0	5.0	12.0	5.0
CP-T3/8-R1/4	3/8	R1/4	43.5	28.5	39.4	87.0	12.0	28	12.0	19.0	8.0	8.0	29.0	9.0
CP-T3/8-R3/8	3/8	R3/8	43.5	29.0	39.9	87.0	13.5	28	12.0	19.0	8.0	8.0	29.0	10.0
CP-T1/2-R3/8	1/2	R3/8	50.6	31.0	43.7	101.1	13.5	29	13.5	22.0	9.9	9.9	53.0	12.0
CP-T1/2-R1/2	1/2	R1/2	50.6	33.0	45.7	101.1	15.5	29	13.5	22.0	9.9	9.9	53.0	14.0

Service tee

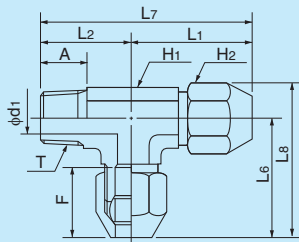

●Millimeter size type

Product number	Applicable tubing outer diameter (mm)	T Thread size (R)	L1 (mm)	L2 (mm)	L6 (mm)	L7 (mm)	L8 (mm)	A (mm)	F Tubing insertion length (mm)	H1 Width across flat (mm)	H2 Width across flat (mm)	d1 (mm)	Min. inner diameter (mm)	Effective sectional area (mm ²)	Weight (g)
CP-ST4-R1/8	4	R1/8	26.8	18.0	26.8	44.8	33.7	8.0	17	10.0	12.0	2.8	2.8	3.0	4.0
CP-ST6-R1/8	6	R1/8	29.1	22.0	29.1	51.1	37.1	12.0	19	12.0	14.0	5.0	5.0	10.0	5.0
CP-ST6-R1/4	6	R1/4	29.1	22.0	29.1	51.1	37.1	12.0	19	12.0	14.0	5.0	5.0	10.0	5.0
CP-ST8-R1/8	8	R1/8	35.5	21.0	35.5	56.5	45.0	10.0	22	9.5	16.5	6.0	6.0	19.5	6.0
CP-ST8-R1/4	8	R1/4	35.5	23.5	35.5	59.0	45.0	13.0	22	9.5	16.5	6.0	6.0	19.5	6.0
CP-ST10-R1/4	10	R1/4	44.8	28.0	44.8	72.8	53.8	12.0	29	12.0	19.0	8.0	8.0	30.0	9.0
CP-ST10-R3/8	10	R3/8	44.8	30.0	44.8	74.8	53.8	13.5	29	12.0	19.0	8.0	8.0	30.0	9.0
CP-ST12-R3/8	12	R3/8	50.2	30.3	50.2	80.5	62.5	13.5	29	13.5	21.5	9.9	9.9	46.0	12.0
CP-ST12-R1/2	12	R1/2	50.2	32.5	50.2	82.7	62.5	15.5	29	13.5	21.5	9.9	9.9	46.0	14.0

●Inch size type

Product number	Applicable tubing outer diameter (inch)	T Thread size (R)	L1 (mm)	L2 (mm)	L6 (mm)	L7 (mm)	L8 (mm)	A (mm)	F Tubing insertion length (mm)	H1 Width across flat (mm)	H2 Width across flat (mm)	d1 (mm)	Min. inner diameter (mm)	Effective sectional area (mm ²)	Weight (g)
CP-ST1/4-R1/8	1/4	R1/8	29.4	22.0	29.4	51.4	37.5	12.0	19	12.0	14.0	5.0	5.0	12.0	5.0
CP-ST1/4-R1/4	1/4	R1/4	29.4	22.0	29.4	51.4	37.5	12.0	19	12.0	14.0	5.0	5.0	12.0	5.0
CP-ST3/8-R1/4	3/8	R1/4	43.9	28.0	43.9	71.9	54.8	12.0	28	12.0	19.0	8.0	8.0	29.0	9.0
CP-ST3/8-R3/8	3/8	R3/8	43.9	30.0	43.9	73.9	54.8	13.5	28	12.0	19.0	8.0	8.0	29.0	9.0
CP-ST1/2-R3/8	1/2	R3/8	50.7	30.3	50.7	81.0	63.3	13.5	29	13.5	22.0	9.9	9.9	53.0	12.0
CP-ST1/2-R1/2	1/2	R1/2	50.7	32.5	50.7	83.2	63.3	16.0	29	13.5	22.0	9.9	9.9	53.0	14.0

Tubing

Clean tubing

Processed tubing

PushOne fitting

QuickSeal fitting

Clean fitting/ Chemifit

Bamboo-shoot fitting

Control switch/ Detachable series

Jig/Tool/ Accessory

Technical information

Reference

Union connector

●Millimeter size type



Product number	Applicable tubing outer diameter (mm)	L (mm)	F Tubing insertion length (mm)	H ₁ Width across flat (mm)	H ₂ Width across flat (mm)	Min. inner diameter (mm)	Effective sectional area (mm ²)	Weight (g)
CP-UC4	4	38.7	17	12.0	12.0	2.8	3.0	3.0
CP-UC6	6	43.2	19	14.0	14.0	5.0	10.0	3.0
CP-UC8	8	57.4	22	16.5	16.5	6.0	22.0	5.0
CP-UC10	10	63.2	29	18.5	19.0	8.0	35.5	9.0
CP-UC12	12	77.4	29	24.0	21.5	10.0	51.0	15.0

●Inch size type

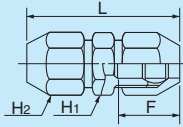

Product number	Applicable tubing outer diameter (inch)	L (mm)	F Tubing insertion length (mm)	H ₁ Width across flat (mm)	H ₂ Width across flat (mm)	Min. inner diameter (mm)	Effective sectional area (mm ²)	Weight (g)
CP-UC1/4	1/4	43.8	19	14.0	14.0	5.0	12.0	3.0
CP-UC3/8	3/8	61.2	28	18.5	19.0	8.0	31.5	9.0
CP-UC1/2	1/2	78.6	29	24.0	22.0	10.0	56.0	15.0

90 degree union elbow

●Millimeter size type



Product number	Applicable tubing outer diameter (mm)	L ₁ (mm)	L ₈ (mm)	F Tubing insertion length (mm)	H ₁ Width across flat (mm)	H ₂ Width across flat (mm)	Min. inner diameter (mm)	Effective sectional area (mm ²)	Weight (g)
CP-UL6	6	29.1	37.1	19	12.0	14.0	5.0	9.0	5.0
CP-UL8	8	39.0(37.0)	48.5(46.5)	22	12.0	16.5	6.0	18.5	8.0
CP-UL10	10	41.8	52.8	29	16.5	19.0	8.0	30.5	12.0
CP-UL12	12	45.7	58.0	29	18.5	21.5	10.0	44.0	16.0

☞ L₁ and L₈ of CP-UL8 have two lengths. Other length is inside parentheses.

●Inch size type

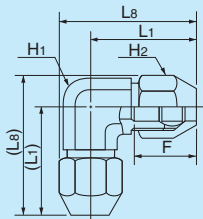

Product number	Applicable tubing outer diameter (inch)	L ₁ (mm)	L ₈ (mm)	F Tubing insertion length (mm)	H ₁ Width across flat (mm)	H ₂ Width across flat (mm)	Min. inner diameter (mm)	Effective sectional area (mm ²)	Weight (g)
CP-UL1/4	1/4	29.4	37.5	19	12.0	14.0	5.0	11.5	5.0
CP-UL3/8	3/8	40.9	51.8	28	16.5	19.0	8.0	27.0	12.0
CP-UL1/2	1/2	46.2	58.8	29	18.5	22.0	10.0	49.0	16.0

Union tee

●Millimeter size type



Product number	Applicable tubing outer diameter (mm)	L ₁ (mm)	L ₅ (mm)	L ₈ (mm)	F Tubing insertion length (mm)	H ₁ Width across flat (mm)	H ₂ Width across flat (mm)	Min. inner diameter (mm)	Effective sectional area (mm ²)	Weight (g)
CP-UT4	4	26.8	53.7	33.7	17	10.0	12.0	2.8	2.5	5.0
CP-UT6	6	29.1	58.2	37.1	19	12.0	14.0	5.0	9.0	8.0
CP-UT8	8	36.5(36.0)	71.9	46.0	22	9.5	16.5	6.0	18.5	11.0
CP-UT10	10	44.3	88.7	55.3	29	12.0	19.0	8.0	30.5	15.0
CP-UT12	12	50.1	100.2	62.5	29	13.5	21.5	10.0	44.0	20.0

☞ L₁ of CP-UT8 has two lengths. Other length is inside parentheses.

●Inch size type

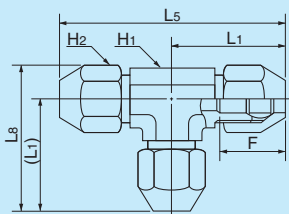

Product number	Applicable tubing outer diameter (inch)	L ₁ (mm)	L ₅ (mm)	L ₈ (mm)	F Tubing insertion length (mm)	H ₁ Width across flat (mm)	H ₂ Width across flat (mm)	Min. inner diameter (mm)	Effective sectional area (mm ²)	Weight (g)
CP-UT1/4	1/4	29.4	58.8	37.5	19	12.0	14.0	5.0	11.5	8.0
CP-UT3/8	3/8	43.4	86.7	54.3	28	12.0	19.0	8.0	27.0	15.0
CP-UT1/2	1/2	50.7	101.3	63.3	29	13.5	22.0	10.0	49.0	20.0

Insertion part

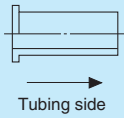

●Millimeter size type

Product number	Applicable tubing outer/inner diameters (mm)
CPI 6×4	6×4
CPI 8×6	8×6
CPI 10×8	10×8
CPI 12×9	12×9
CPI12×10	12×10

●Inch size type

Product number	Applicable tubing outer/inner diameters (mm)
CPI1/4	6.35×4.57
CPI3/8	9.53×6.99
CPI1/2	12.7×9.56

⚠ Caution: When using a flexible tubing such as a polyolefin resin tubing, insert it first to the insertion part before connecting to a fitting.

Nut

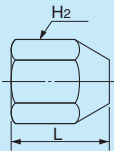

Product number	Applicable tubing outer diameter		L (mm)	H ₂ Width across flat (mm)	Weight (g)
	(mm)	(Inch)			
CPN4	4	—	13.5	12.0	1.0
CPN6	6	1/4	15.0	14.0	1.0
CPN8	8	—	19.0	16.5	2.0
CPN10	10	3/8	22.0	21.5	2.0
CPN12	12	—	26.5	22.0	4.0
CPN1/2	—	1/2	26.5	22.0	4.0

⚠ Caution: When you detach and re-attach a tubing, replace the nut with a new one.

Sleeve

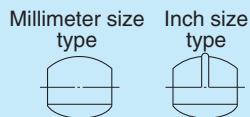

●Millimeter size type

Product number	Applicable tubing outer diameter (mm)	Weight (g)
CPS4	4	0.1
CPS6	6	0.1
CPS8	8	0.2
CPS10	10	0.4
CPS12	12	0.4

●Inch size type

Product number	Applicable tubing outer diameter (inch)	Weight (g)
CPS1/4	1/4	0.1
CPS3/8	3/8	0.3
CPS1/2	1/2	0.5

⚠ Caution: When you detach and re-attach a tubing, replace the sleeve with a new one.

Barb Type

Features

- Various shapes can be made by combining the connector and each part.
- Seal-processed PT thread requires no sealing tape.

Product number example

BN 4 - PT1/8

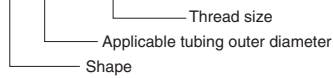

Applicable tubing

Polyurethane tubing



U5



Operating fluid, working temperature range

Operating fluid	Working temperature range
Air	-40°C~+80°C

Pressure condition

Maximum working pressure: 0.4MPa
Negative pressure performance: -99.975kPa

See page 34 for the common handling instructions for fittings.

How to attach

Insert a tubing into the tubing connection part (bamboo-shoot shaped) until the tubing reaches the end. The thread part is attached in the same way as the PushOne series.

Sample combinations of barb fittings

Various shapes of barb fittings can be made by combining the connector and each part.

<p>Elbow shape</p>	<p>Sample combination</p> <p>Tubing size : 4x2.5</p> <p>Thread size : M5</p>	<p>(Body) Elbow block</p> <p>BL-M5</p>	+	<p>(Thread side) Adapter nipple</p> <p>BAN-M5</p>	+	<p>(Tubing side) Connector</p> <p>BN4-M5</p>				
<p>Tee shape</p>	<p>Sample combination</p> <p>Tubing size : 6x4</p> <p>Thread size : R1/8</p>	<p>(Body) Tee block</p> <p>BT-M5</p>	+	<p>(Thread side) Adapter nipple</p> <p>BAN-M5</p>	+	<p>(Tubing side) Adapter bush</p> <p>BAB-M5-PT1/8</p>	+	<p>(Tubing side) Connector</p> <p>BN6-M5</p>	+	<p>(Tubing side) Connector</p> <p>BN6-M5</p>
<p>Service tee shape</p>	<p>Sample combination</p> <p>Tubing size : 3.5x2</p> <p>Thread size : M5</p>	<p>(Body) Tee block</p> <p>BT-M5</p>	+	<p>(Thread side) Adapter nipple</p> <p>BAN-M5</p>	+	<p>(Tubing side) Connector</p> <p>BN3.5-M5</p>	+	<p>(Tubing side) Connector</p> <p>BN3.5-M5</p>		
<p>Union elbow shape</p>	<p>Sample combination</p> <p>Tubing size : 4x2.5</p>	<p>(Body) Elbow block</p> <p>BL-M5</p>	+	<p>(Tubing side) Connector</p> <p>BN4-M5</p>	+	<p>(Tubing side) Connector</p> <p>BN4-M5</p>				
<p>Union tee shape</p>	<p>Sample combination</p> <p>Tubing size : 4x2.5</p>	<p>(Body) Tee block</p> <p>BT-M5</p>	+	<p>Connector</p> <p>BN4-M5</p>	+	<p>(Tubing side) Connector</p> <p>BN4-M5</p>	+	<p>Connector</p> <p>BN4-M5</p>		
<p>Universal elbow shape</p>	<p>Sample combination</p> <p>Tubing size : 6x4</p> <p>Thread size : PT1/8</p>	<p>(Body) Universal elbow block</p> <p>BUVL-M5</p>	+	<p>(Thread side) Adapter bush</p> <p>BAB-M5-PT1/8</p>	+	<p>(Tubing side) Connector</p> <p>BN6-M5</p>				
<p>Universal tee shape</p>	<p>Sample combination</p> <p>Tubing size : 3.5x2</p> <p>Thread size : M5</p>	<p>(Body, Thread side) Universal tee block</p> <p>BUVT-M5</p>	+	<p>Connector</p> <p>BN3.5-M5</p>	+	<p>(Tubing side) Connector</p> <p>BN3.5-M5</p>				

Connector



●Millimeter size type

Product number	Applicable tubing outer/inner diameters (mm)	Thread size (M,R)	L (mm)	F Tubing insertion length (mm)	d ₂ (mm)	Min. inner diameter (mm)	Weight (g)
BN3.5-M5	3.5×2	M5×0.8	13.5	6.5	1.0	1.0	2.0
BN4-M5	4×2.5	M5×0.8	13.5	6.5	1.5	1.5	2.0
BN6-M5	6×4	M5×0.8	15.0	8.0	3.0	2.0	2.5

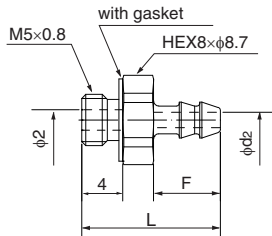

Barb type parts

Elbow block

Product number : BL-M5

Weight 5.5g

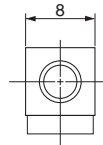
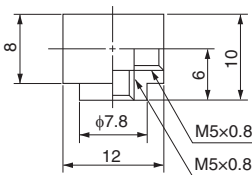

Adapter nipple

Product number : BAN-M5

Weight 2.0g

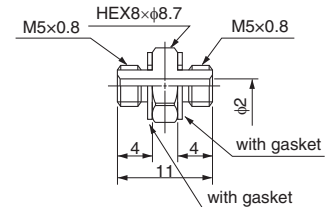

Tee block

Product number : BT-M5

Weight 5.0g

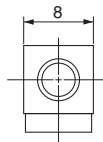
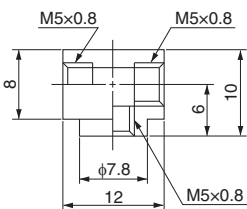

Adapter bush

Product number : BAB-M5-PT1/8

Weight 6.0g

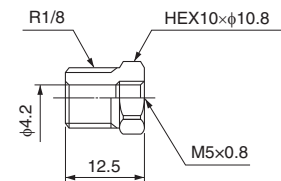

Universal elbow block

Product number : BUVL-M5

Weight 7.5g

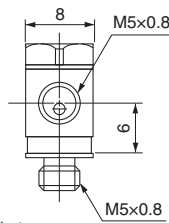
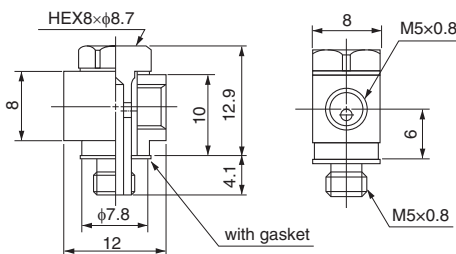

Plug

Product number : BBP-M5

Weight 1.5g

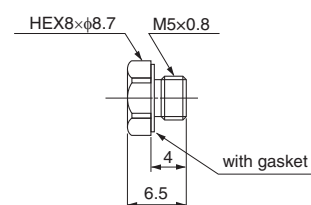

Universal tee block

Product number : BUVT-M5

Weight 7.0g

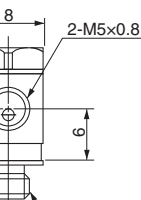
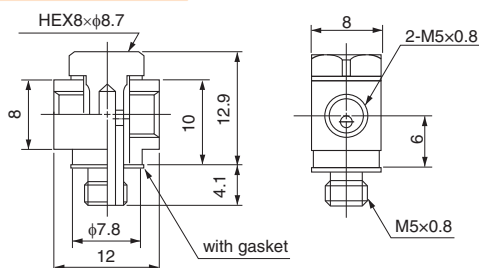

Gasket

Product number : MRG-5-01

Thickness 0.4mm

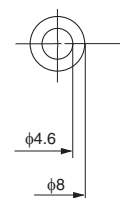

Tubing

Clean tubing

Processed tubing

PushOne fitting

QuickSeal fitting

Clean fitting/ChemiFit

Bamboo-shoot fitting

Control switch/Detachable series

Jig/Tool/Accessory

Technical information

Reference

CONTROL

Control Switch and Detachable Series

Handling instructions for control switch and detachable series

Safety Note

This Safety Note provides indications on the correct use of the product in order to prevent harm to people and property. The indications are classified into three categories, "danger", "warning", and "caution", depending on the level of potential harm due to improper use. Each category contains important instructions on safety that should be followed in addition to the latest ISO 4414(*1), JIS B 8370(*2), ISO 4413 (*3), and JIS B 8361 (*4).

(*1) ISO 4414 Pneumatic fluid power...Recommendations for the application of equipment to transmission and control systems.

(*2) JIS B 8370(1988) Pneumatic System General Rules

(*3) ISO 4413 Hydraulic fluid power...General rules for the application of equipment to transmission and control systems.

(*4) JIS B 8361 Hydraulic System General Rules

DANGER

Where inappropriate use of this equipment may cause death or severe injury and where immediate warning of a dangerous situation is mandated.

WARNING

Where inappropriate use of this equipment may cause death or severe injury.

CAUTION

Where inappropriate use of this equipment may cause minor injury.

Before Selection

DANGER

- Cannot use for machines or equipment for life support.
- To use for machines or equipment that require extremely high safety, measures have to be taken to prevent danger in the event tubing pulls out, bursts or leaks.

WARNING

- Please contact us before using our products under conditions other than those specified in the catalog.
- Please contact us before using our products for equipment, machines, various types of vehicles, and passenger aircraft, for leisure equipment passenger transport, for medical equipment that would cause human harm in case the specifications are not properly followed, and for machines in contact with food or drinking water.

Selection

WARNING

- Please check that our products are used under the "use conditions" specified in the catalog.
- Do not use our products when a caustic or flammable gas is used as the fluid or is in the environment.

CAUTION

- Cannot be used in locations subject to excessive vibration or impact.
- If use conditions differ between the tubing and the fittings, use them under the lower specified conditions.
- For Nitta's fitting products, use tubing products that Nitta specifies or JIS B 8381-1995 on-spec products.
- When a chemical is used in fluid or the environment, see "Chemical resistance specification table". Contact us for chemical resistance of plating.
- When spatter (hot wasted metal) is likely to stick to the fittings, use flame-resistant products only. Otherwise the spatter may cause a fire.
- Couplers and nipples of the Q.D.C. 101 series and the 103 series cannot be connected to other manufactures products.
- The maximum operating pressure varies for Chemifit C1 speed controller depending on the operating temperature. Please be sure to refer to "Relationship graph between operating temperature and maximum operating pressure" before selecting.

Installation

WARNING

- Fix tubes in place when installing them in a situation where unexpected disconnection of the tubing and connector could cause harm to people or property.

CAUTION

- Attach the control, switch, and detachable series following the instruction manual of the fitting series that has the same tubing connector shape (ex. PushOne, QuickSeal, and Chemifit series).
- Do not throw or drop the control, switch, and detachable series. The impact may cause internal damage even if no outer damage is found.
- Because the connection part of the fitting may swell or crack depending on the material, check the strength of the part when connecting.
- Fittings with a sealing processed thread may swell due to the action of an operating fluid such as organic solvent, allowing fluid leakage from the thread part.
- Do not bend the pipe sharply near the tubing insertion port (sleeve end) of the fitting. Keep the tubing straight for twice as long as the tubing diameter from the insertion port.
- Do not use a fitting with a damaged thread or damaged tubing insertion port. In addition, please make sure that the product is not damaged when using a reusable product.
- Nitta only guarantees products fabricated by designated companies.
- Please do not install with tension applied on the tubing or a torsional or bending load applied on the fittings.
- When using water as the operating fluid for the fitting series that has the same tubing connector shape (ex. PushOne, QuickSeal, and Chemifit series), avoid installing to a place where assembly could be moved.
- You cannot re-use sleeves that have QuickSeal series tubing connector shape. Replace them with a new sleeve each time you detach.
- Please do not use the products in an environment where foreign materials may enter the product or come into contact with its internal parts. Doing so may result in damage or leakage.
- Please do not use the products in a manner where the screw side or the tube insertion opening side is rotated or oscillated repeatedly.

Usage

WARNING

- Nitta's products should be handled only by designers who have sufficient knowledge of equipment, instruments and systems in which our products are to be installed, or by persons responsible for determining specifications. Test and analysis should be conducted if necessary. The designers or the responsible persons are liable for the performance and the safety of the equipment, instruments and systems.

CAUTION

- When water is used as fluid, do not allow it to freeze.
- Do not touch a tubing at pressurization. Improperly treating or touching a tubing at pressurization may lead to danger from unexpected breakage or leakage of fluid.
- Do not touch a tubing when the operating fluid is hot. Doing so may cause burns.
- Use of the control, switch and detachable series in a place contaminated with many metal particles or dust could cause operation problems. Do not use them in such an environment.

Storage

CAUTION

- When storing unused products, make sure to keep them in a clean place to prevent dust. When fine particles such as dust enter the inside of tubing products or the connected equipment, they may cause problems.
- Keep products in a dry place below 40°C avoiding direct sunlight.
- Do not use tubing products that have been stored for more than one year after production.
- The packaging of clean tubes should be opened just before use. Store the tubes in a box in a clean place in a dust-free environment.

Maintenance and Inspection

CAUTION

- Before handling or removing Nitta's products, be sure to check the safety by shutting off the power supply, stopping the pressure supply, evacuating pressurized air in the pipe, and terminating the operation of equipment, instruments, and systems.
- Please be sure to make periodic inspections. Confirm that there is no degradation such as outer damage, corrosion, and abrasion and replace any damaged piping.
- If you are using a product with QuickSeal series tubing mounting shape continuously for a long period of time, or if you are using a product continuously under a high temperature range within the operating temperature range, please tighten the nut additionally on a regular basis.

Disposal

CAUTION

- Dispose of unnecessary products as industrial waste or have them disposed of by a waste disposal firm. In particular, incineration of products containing fluorocarbon may generate a toxic pyrolysis gas.

CONTROL INDEX

Tubing

Clean tubing

Processed tubing

PushOne fitting

QuickSeal fitting

Clean fitting/
Chemifit

Bamboo-shoot fitting

Control switch/
Detachable series

Jig/Tool/
Accessory

Technical information

Reference

Control Series

Chemifit™ C1 speed controller



- Suitable for environment (atmosphere) that requires chemical resistance
- PushOne connection
- Inline type (ESU) allows central control on the piping

P.136

Control Series

Compact speed controller



- Smaller than the conventional model
- PushOne connection
- Electroless nickel plated
- Sealing-processed R thread

P.138

Control Series

Speed controller



- PushOne connection
- Inline type (ASU) allows central control on the piping line
- Electroless nickel plated

P.140

Switch Series

Ball valve



- Enables compact piping
- PushOne connection
- Position of handle can be changed
- Nickel plated

P.143

Control Series

Throttle valve



- Fine control of flow rate
- Inline type (ASU) allows central control on the piping line
- PushOne connection
- Electroless nickel plated

P.146

Miniature valve



- Easy flow rate control
- PushOne connection for millimeter size type (quick seal type for inch size type)

P.148

Switch Series

Valve built-in connector



- Valve inside fitting is opened/closed by attaching/detaching the tubing
- PushOne connection
- Electroless nickel plated

P.151

Detachable Series

Q.D.C 101



- Push-To-Connect type
- Automatic opening/closing valve inside the coupler
- PushOne fitting integrated types available

P.152

Q.D.C 103



- Push-To-Connect type
- Automatic opening/closing valve inside the coupler
- Smaller than 101 series
- Electroless nickel plated

P.155

Chemifit™ C1 Speed Controller

PushOne™ Type

Features

- Suitable for environment (atmosphere) that requires chemical resistance
Mostly made of special polypropylene resin and SUS304. Special EPDM is used for sealing material.
- PushOne connection of tubing
Jig and tool not required for connecting the tubes.
- Inline type (ESU) allows central control on a pipe line
Various kinds of piping are possible by fixing with connector pins and brackets.

Cross-sectional structure diagram

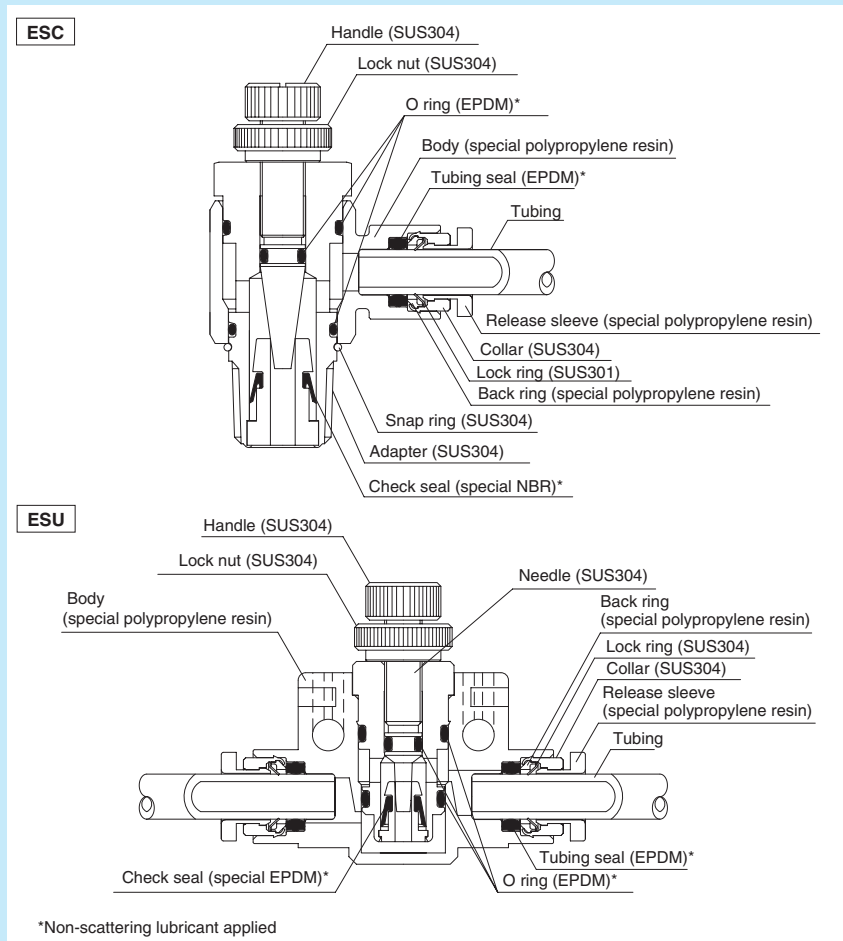

Operating fluid, working temperature range

Operating fluid	Working temperature range
Air	+5°C~+60°C

Pressure condition

Maximum working pressure:
0.7MPa(at20°C)

Relation between the working temperature and the maximum working pressure

Maximum working pressure varies with working temperature (environmental temperature). For use at an abnormal temperature, always check the maximum working pressure change in the graph below and keep pressure within the range.

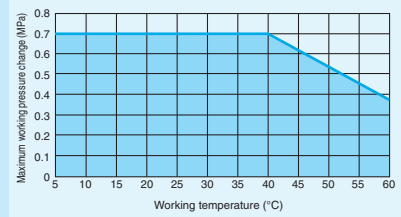

Handling instructions

- ⚠ **Caution:** When the working conditions of tubes and fittings differ, use them under the lower specified conditions.
- ⚠ **Caution:** Tighten the lock nut and handle by hand, not by using a spanner.
- ⚠ **Caution:** The needle part stops when fully opened. Forced rotation could cause damage.
- ⚠ **Caution:** Cannot be used at a negative pressure.
- ⚠ **Caution:** Non-scattering lubricant is applied to some parts. Contact us for details.
- ⚠ **Caution:** Be sure to check the air flow direction when attaching a speed controller to equipment.
- ⚠ **Caution:** Do not bend the pipe sharply near the tubing insertion port (sleeve end) of the fitting. Keep the tubing straight for twice as long as the tubing diameter from the insertion port.
- ⚠ **Caution:** Cannot be used for sealing purposes.

➔ See page 134 for the common handling instructions for control, switch and detachable series products.

Product number example

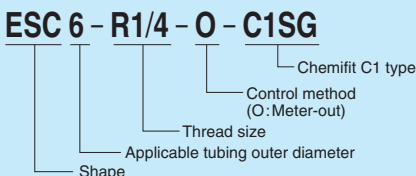

Inline type connection



Applicable tubing

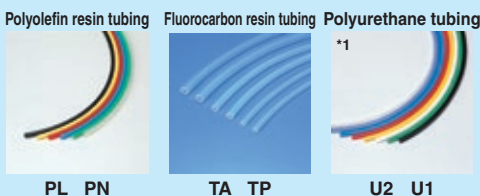

(*1) Combinatory use of U2 or U1 tubing and Chemifit C1 speed controller mixes general and clean type performances. When using them together in a clean environment, be aware of how this could lower the cleanliness level.

Control mechanism

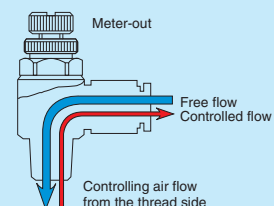

Reference

Flow characteristic graph.....P.165

Elbow type

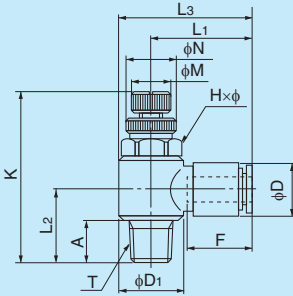

●Millimeter size type

Product number	Applicable tubing outer diameter (mm)	T Thread size (R)	L ₁ (mm)	L ₂ (mm)	L ₃ (mm)	K		A (mm)	F Tubing insertion length (mm)	H×φ Width across flat (mm)	N (mm)	M (mm)	D (mm)	D ₁ (mm)	Weight (g)
						Full open (mm)	Full closed (mm)								
ESC4-R1/8-O-C1SG	4	R1/8	23.9	17.7	30.6	46.8	42.0	9.7	14	13.0×14.0	13.0	10.0	10.0	13.5	26.0
ESC6-R1/8-O-C1SG	6	R1/8	23.2	17.7	30.0	46.8	42.0	9.7	15	13.0×14.0	13.0	10.0	13.0	13.5	27.0
ESC6-R1/4-O-C1SG	6	R1/4	25.2	23.1	34.9	55.2	48.7	13.6	15	17.0×18.3	13.0	10.0	13.0	19.4	51.0
ESC8-R1/8-O-C1SG	8	R1/8	24.8	17.7	31.6	46.8	42.0	9.7	16	13.0×14.0	13.0	10.0	15.0	13.5	29.0
ESC8-R1/4-O-C1SG	8	R1/4	26.8	23.1	36.5	55.2	48.7	13.6	16	17.0×18.3	13.0	10.0	15.0	19.4	52.0
ESC8-R3/8-O-C1SG	8	R3/8	28.8	24.6	40.8	59.0	51.5	14.1	16	21.0×22.6	16.0	13.0	15.0	24.0	84.0
ESC10-R1/4-O-C1SG	10	R1/4	29.7	23.1	39.4	55.2	48.7	13.6	19	17.0×18.3	13.0	10.0	18.0	19.4	55.0
ESC10-R3/8-O-C1SG	10	R3/8	31.7	24.6	43.7	59.0	51.5	14.1	19	21.0×22.6	16.0	13.0	18.0	24.0	87.0
ESC12-R3/8-O-C1SG	12	R3/8	32.7	24.6	44.7	59.0	51.5	14.1	20	21.0×22.6	16.0	13.0	20.5	24.0	116.0

Inline type

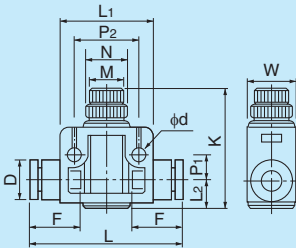

●Millimeter size type

Product number	Applicable tubing outer diameter (mm)	L (mm)	L ₁ (mm)	L ₂ (mm)	P ₁ (mm)	P ₂ (mm)	K		F Tubing insertion length (mm)	N (mm)	M (mm)	D (mm)	d (mm)	W (mm)	Weight (g)
							Full open (mm)	Full closed (mm)							
ESU4-C1SG	4	42.7	20.0	6.4	6.0	14.0	29.5	26.9	14	8.0	8.0	9.7	3.2	10.6	11.0
ESU6-C1SG	6	48.5	28.0	9.0	8.2	20.0	43.5	39.8	15	13.0	10.0	12.5	4.2	15.0	32.0
ESU8-C1SG	8	56.6	30.0	10.3	9.2	22.0	47.7	42.1	16	13.0	10.0	14.5	4.2	17.6	48.0

JIS symbol mark

JIS symbols are marked on both sides of the body.

JIS symbol

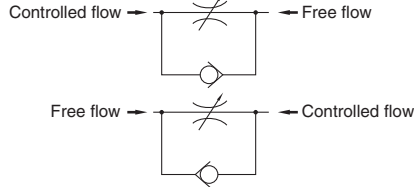

Control direction mark

Control directions are marked by arrows on the top of the body.

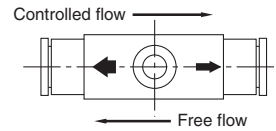

Connector pin (polypropylene resin)

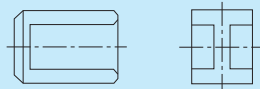

●Connector pin

Product number	Applicable fitting product number
HPN4-C1	ESU4-C1SG
HPN6-C1	ESU6-C1SG
	ESU8-C1SG

Bracket (SUS304)

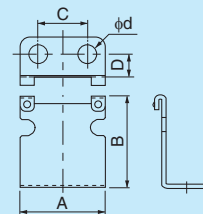

●Bracket

Product number	Applicable fitting product number	A (mm)	B (mm)	C (mm)	D (mm)	d (mm)
SBRK4	ESU4-C1SG	18.0	18.5	10.0	6.5	5.0
SBRK6	ESU6-C1SG	24.0	26.0	14.0	6.5	5.0
SBRK8	ESU8-C1SG	26.0	30.0	14.0	6.5	5.0

Tubing

Clean tubing

Processed tubing

PushOne fitting

QuickSeal fitting

Clean fitting/Chemifit

Bamboo-shoot fitting

Control switch/Detachable series

Jig/Tool/Accessory

Technical information

Reference

Compact Speed Controller

PushOne™ Type

Features

- Smaller than the conventional model
- Easy fine adjustment at low flow rate
Compact size with a maximum flow rate comparable to that of the conventional model. (See the graph.)
- PushOne connection of tubing
Jig and tool not required for connecting the tubes.
- Flame-resistant resin (compliant with V-0 of UL94 standard)
Made of flame-resistant resin PBT. High self-extinguishing performance is compliant with V-0 of UL94 standard. Usable under an environment with spatters.
- Electroless nickel plated
Prevents degradation of surface and dissolution of copper ions into fluid.
- Sealing-processed R thread
Sealing tape is not required.



[Comparison of control flow with the conventional model]
For elbow type with φ6 tube and R1/8 thread

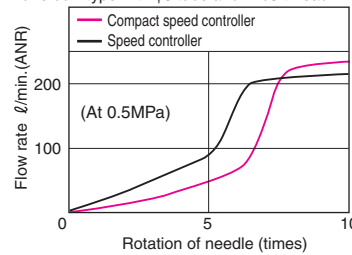

Cross-sectional structure diagram

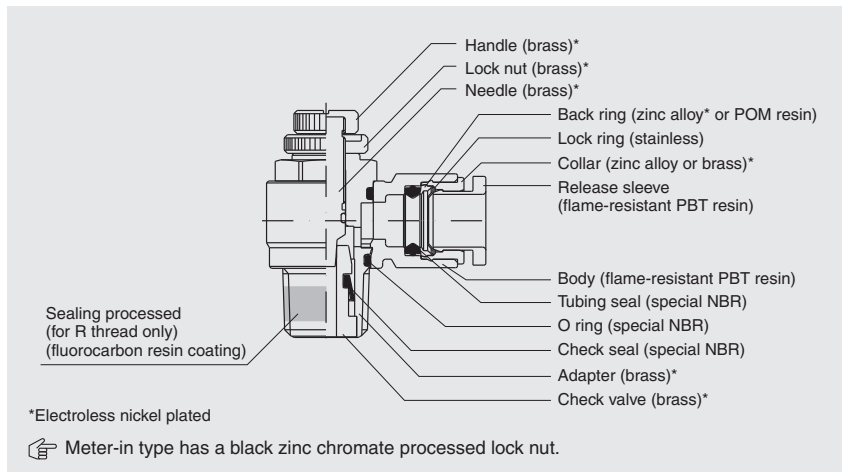

Product number example

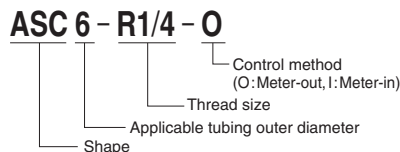

Distinction of Meter-out/in types

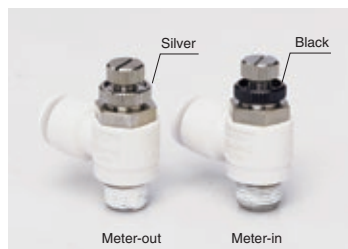

Meter-out/in types are distinguished by the color of the lock nut.

Control mechanism

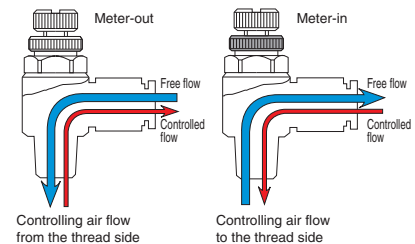

Reference

Flow characteristic graph.....P.163
UL-94 standard flame test.....P.195

Applicable tubing



(*1) Combinatory use of PL or PN tubing and compact speed controller mixes general and clean type performances. When using them together in a clean environment, be aware of how this could lower the cleanliness level.

Elbow type

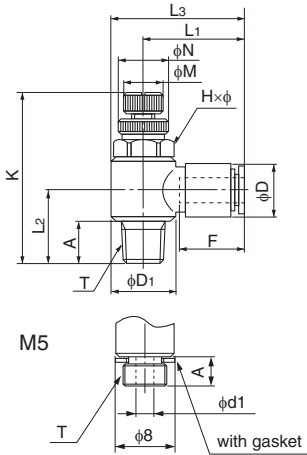

●Millimeter size type

Product number	Applicable tubing outer diameter (mm)	T Thread size (M,R)	L1 (mm)	L2 (mm)	L3 (mm)	K		A (mm)	F Tubing insertion length (mm)	H×φ Width across flat (mm)	N (mm)	M (mm)	D (mm)	D1 (mm)	Weight (g)
						Full open (mm)	Full closed (mm)								
ASC4-M5-O	4	M5×0.8	18.0	10.1	22.8	28.6	25.8	3.4	13.5	8.0×9.0	8.0	5.0	9.8	9.6	8.0
ASC4-M5-I	4	M5×0.8	18.0	10.1	22.8	28.6	25.8	3.4	13.5	8.0×9.0	8.0	5.0	9.8	9.6	8.0
ASC4-R1/8-O	4	R1/8	20.1	13.7	27.2	36.0	31.0	7.3	13.5	12.0×13.5	11.0	8.0	9.8	14.2	19.0
ASC4-R1/8-I	4	R1/8	20.1	13.7	27.2	36.0	31.0	7.3	13.5	12.0×13.5	11.0	8.0	9.8	14.2	19.0
ASC6-M5-O	6	M5×0.8	20.3	10.6	25.1	28.6	25.8	3.4	15.0	8.0×9.0	8.0	5.0	12.6	9.6	9.0
ASC6-M5-I	6	M5×0.8	20.3	10.6	25.1	28.6	25.8	3.4	15.0	8.0×9.0	8.0	5.0	12.6	9.6	9.0
ASC6-R1/8-O	6	R1/8	21.8	13.7	28.9	36.0	31.0	7.3	15.0	12.0×13.5	11.0	8.0	12.6	14.2	20.0
ASC6-R1/8-I	6	R1/8	21.8	13.7	28.9	36.0	31.0	7.3	15.0	12.0×13.5	11.0	8.0	12.6	14.2	20.0
ASC6-R1/4-O	6	R1/4	23.6	18.2	32.9	40.3	35.3	10.8	15.0	14.0×15.8	13.0	10.0	12.6	18.5	33.0
ASC6-R1/4-I	6	R1/4	23.6	18.2	32.9	40.3	35.3	10.8	15.0	14.0×15.8	13.0	10.0	12.6	18.5	33.0
ASC8-R1/8-O	8	R1/8	26.6	14.7	33.7	36.0	31.0	7.3	16.0	12.0×13.5	11.0	8.0	14.6	14.2	21.0
ASC8-R1/8-I	8	R1/8	26.6	14.7	33.7	36.0	31.0	7.3	16.0	12.0×13.5	11.0	8.0	14.6	14.2	21.0
ASC8-R1/4-O	8	R1/4	24.9	18.2	34.1	40.3	35.3	10.8	16.0	14.0×15.8	13.0	10.0	14.6	18.5	34.0
ASC8-R1/4-I	8	R1/4	24.9	18.2	34.1	40.3	35.3	10.8	16.0	14.0×15.8	13.0	10.0	14.6	18.5	34.0
ASC8-R3/8-O	8	R3/8	26.9	19.9	38.2	46.3	41.3	11.1	16.0	19.0×21.0	16.0	13.0	14.6	22.6	62.0
ASC8-R3/8-I	8	R3/8	26.9	19.9	38.2	46.3	41.3	11.1	16.0	19.0×21.0	16.0	13.0	14.6	22.6	62.0
ASC10-R1/8-O	10	R1/8	30.4	16.2	37.5	36.0	31.0	7.3	19.0	12.0×13.5	11.0	8.0	17.5	14.2	23.0
ASC10-R1/8-I	10	R1/8	30.4	16.2	37.5	36.0	31.0	7.3	19.0	12.0×13.5	11.0	8.0	17.5	14.2	23.0
ASC10-R1/4-O	10	R1/4	31.5	19.6	40.7	40.3	35.3	10.8	19.0	14.0×15.8	13.0	10.0	17.5	18.5	37.0
ASC10-R1/4-I	10	R1/4	31.5	19.6	40.7	40.3	35.3	10.8	19.0	14.0×15.8	13.0	10.0	17.5	18.5	37.0
ASC10-R3/8-O	10	R3/8	30.3	19.9	41.6	46.3	41.3	11.1	19.0	19.0×21.0	16.0	13.0	17.5	22.6	65.0
ASC10-R3/8-I	10	R3/8	30.3	19.9	41.6	46.3	41.3	11.1	19.0	19.0×21.0	16.0	13.0	17.5	22.6	65.0
ASC10-R1/2-O	10	R1/2	32.4	24.5	46.0	54.5	49.5	14.4	19.0	24.0×26.0	20.0	16.0	17.5	27.4	109.0
ASC10-R1/2-I	10	R1/2	32.4	24.5	46.0	54.5	49.5	14.4	19.0	24.0×26.0	20.0	16.0	17.5	27.4	109.0
ASC12-R3/8-O	12	R3/8	37.7	21.2	49.0	46.3	41.3	11.1	20.0	19.0×21.0	16.0	13.0	20.0	22.6	67.0
ASC12-R3/8-I	12	R3/8	37.7	21.2	49.0	46.3	41.3	11.1	20.0	19.0×21.0	16.0	13.0	20.0	22.6	67.0
ASC12-R1/2-O	12	R1/2	33.7	24.5	47.4	54.5	49.5	14.4	20.0	24.0×26.0	20.0	16.0	20.0	27.4	111.0
ASC12-R1/2-I	12	R1/2	33.7	24.5	47.4	54.5	49.5	14.4	20.0	24.0×26.0	20.0	16.0	20.0	27.4	111.0

Universal type

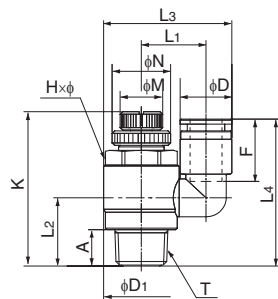

●Millimeter size type

Product number	Applicable tubing outer diameter (mm)	T Thread size (M,R)	L1 (mm)	L2 (mm)	L3 (mm)	L4 (mm)	K		A (mm)	F Tubing insertion length (mm)	H×φ Width across flat (mm)	N (mm)	M (mm)	D (mm)	D1 (mm)	Weight (g)
							Full open (mm)	Full closed (mm)								
ASD4-M5-O	4	M5×0.8	9.9	10.1	18.5	24.5	28.6	25.8	3.4	11.0	8.0×9.0	8.0	5.0	8.0	9.6	8.0
ASD4-M5-I	4	M5×0.8	9.9	10.1	18.5	24.5	28.6	25.8	3.4	11.0	8.0×9.0	8.0	5.0	8.0	9.6	8.0
ASD4-R1/8-O	4	R1/8	12.2	13.7	23.1	28.0	36.0	31.0	7.3	11.0	12.0×13.5	11.0	8.0	8.0	14.2	18.0
ASD4-R1/8-I	4	R1/8	12.2	13.7	23.1	28.0	36.0	31.0	7.3	11.0	12.0×13.5	11.0	8.0	8.0	14.2	18.0
ASD6-M5-O	6	M5×0.8	9.9	10.1	19.5	25.9	28.6	25.8	3.4	12.0	8.0×9.0	8.0	5.0	10.0	9.6	8.0
ASD6-M5-I	6	M5×0.8	9.9	10.1	19.5	25.9	28.6	25.8	3.4	12.0	8.0×9.0	8.0	5.0	10.0	9.6	8.0
ASD6-R1/8-O	6	R1/8	12.2	13.7	24.1	29.4	36.0	31.0	7.3	12.0	12.0×13.5	11.0	8.0	10.0	14.2	19.0
ASD6-R1/8-I	6	R1/8	12.2	13.7	24.1	29.4	36.0	31.0	7.3	12.0	12.0×13.5	11.0	8.0	10.0	14.2	19.0
ASD6-R1/4-O	6	R1/4	14.3	17.1	28.4	32.9	40.3	35.3	10.8	12.0	14.0×15.8	13.0	10.0	10.0	18.5	32.0
ASD6-R1/4-I	6	R1/4	14.3	17.1	28.4	32.9	40.3	35.3	10.8	12.0	14.0×15.8	13.0	10.0	10.0	18.5	32.0
ASD8-R1/8-O	8	R1/8	16.1	14.4	30.5	35.1	36.0	31.0	7.3	16.0	12.0×13.5	11.0	8.0	14.6	14.2	22.0
ASD8-R1/8-I	8	R1/8	16.1	14.4	30.5	35.1	36.0	31.0	7.3	16.0	12.0×13.5	11.0	8.0	14.6	14.2	22.0
ASD8-R1/4-O	8	R1/4	18.2	18.0	34.8	38.7	40.3	35.3	10.8	16.0	14.0×15.8	13.0	10.0	14.6	18.5	36.0
ASD8-R1/4-I	8	R1/4	18.2	18.0	34.8	38.7	40.3	35.3	10.8	16.0	14.0×15.8	13.0	10.0	14.6	18.5	36.0
ASD8-R3/8-O	8	R3/8	20.3	18.7	38.9	39.4	46.3	41.3	11.1	16.0	19.0×21.0	16.0	13.0	14.6	22.6	64.0
ASD8-R3/8-I	8	R3/8	20.3	18.7	38.9	39.4	46.3	41.3	11.1	16.0	19.0×21.0	16.0	13.0	14.6	22.6	64.0
ASD10-R1/4-O	10	R1/4	18.2	18.0	36.2	42.6	40.3	35.3	10.8	19.0	14.0×15.8	13.0	10.0	17.5	18.5	38.0
ASD10-R1/4-I	10	R1/4	18.2	18.0	36.2	42.6	40.3	35.3	10.8	19.0	14.0×15.8	13.0	10.0	17.5	18.5	38.0
ASD10-R3/8-O	10	R3/8	20.3	18.7	40.3	43.3	46.3	41.3	11.1	19.0	19.0×21.0	16.0	13.0	17.5	22.6	66.0
ASD10-R3/8-I	10	R3/8	20.3	18.7	40.3	43.3	46.3	41.3	11.1	19.0	19.0×21.0	16.0	13.0	17.5	22.6	66.0

Tubing
Clean tubing
Processed tubing
PushOne fitting
QuickSeal fitting
Clean fitting/Chemifit
Bamboo-shoot fitting
Control switch/Detachable series
Jig/Tool/Accessory
Technical information
Reference

Speed Controller

PushOne™ Type

Features

- PushOne connection of tubing
Jig and tool not required for connecting the tubes.
- Centrally controllable on a pipe line
Various kinds of piping are possible by fixing with connector pins and brackets.
- Electroless nickel plated
Prevents degradation of surface and dissolution of copper ions into fluid.
- Flame-resistant resin (compliant with V-0 of UL94 standard)
Made of flame-resistant resin PBT. High self-extinguishing performance is compliant with V-0 of UL94 standard. Usable under an environment with spatters.

Cross-sectional structure diagram

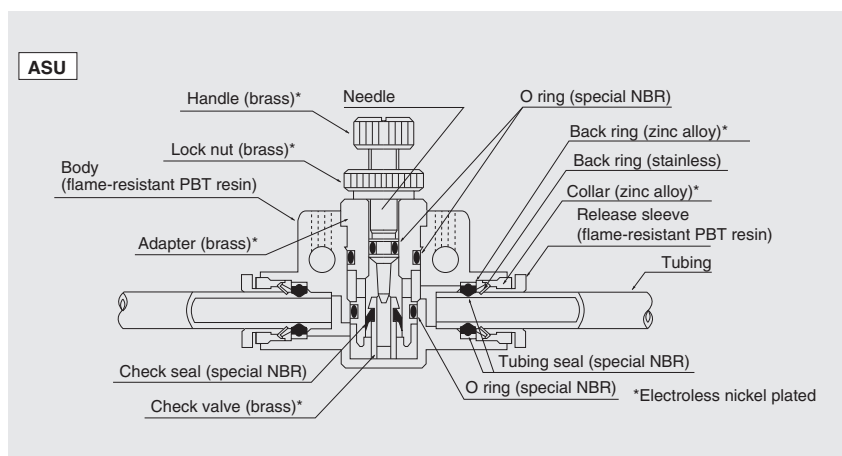

Applicable tubing



(*1) Combinatory use of PL, PN, TA or TP tubing and Speed controller mixes general and clean type performances.
When using them together in a clean environment, be aware of how this could lower the cleanliness level.

Operating fluid, working temperature range

Operating fluid	Working temperature range
Air	+5°C~+60°C

Pressure condition

Maximum working pressure: 1.0MPa

Handling instructions

- ⚠ **Caution:** When the working conditions of tubes and fittings differ, use them under the lower specified conditions.
- ⚠ **Caution:** Tighten the lock nut and handle by hand, not by using a spanner.
- ⚠ **Caution:** The needle part stops when fully opened. Forced rotation could cause damage.
- ⚠ **Caution:** Cannot be used at a negative pressure.
- ⚠ **Caution:** Be sure to check the air flow direction when attaching a speed controller to equipment.
- ⚠ **Caution:** Do not bend the pipe sharply near the tubing insertion port (sleeve end) of the fitting. Keep the tubing straight for twice as long as the tubing diameter from the insertion port.
- ⚠ **Caution:** Cannot be used for sealing purposes.

☞ See page 134 for the common handling instructions for control, switch and detachable series products.

Inline type connection



Controllers can be connected with a connector pin.

Reference

Flow characteristic graph.....P.167
UL-94 standard flame test.....P.195

Inline type

●Millimeter size type



Product number	Applicable tubing outer diameter (mm)	L (mm)	L ₁ (mm)	L ₂ (mm)	P ₁ (mm)	P ₂ (mm)	K		F Tubing insertion length (mm)	N (mm)	M (mm)	D (mm)	d (mm)	W (mm)	Weight (g)
							Full open (mm)	Full closed (mm)							
ASU4	4	41.8	20.0	6.4	6.0	14.0	29.5	26.9	13.5	8.0	5.0	9.8	3.2	10.6	11.5
ASU6	6	47.6	28.0	9.0	8.2	20.0	43.5	39.8	15.0	11.0	8.0	12.6	4.2	15.0	31.0
ASU8	8	55.8	30.0	10.3	9.2	22.0	47.7	42.1	16.0	13.0	10.0	14.6	4.2	17.6	48.0

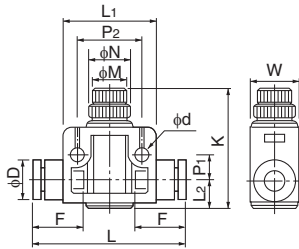

JIS symbol mark

JIS symbols are marked on both sides of the body.

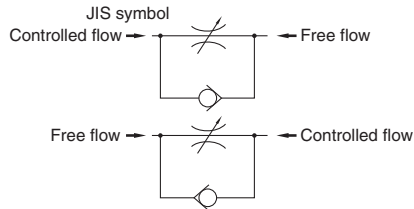

Control direction mark

Control directions are marked by arrows on the top of the body.

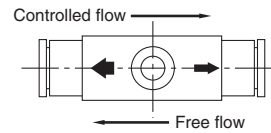

Connector pin

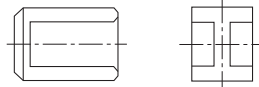

●Connector pin

Product number	Applicable fitting product number
HPN4	ASU4
HPN6	ASU6
	ASU8

Bracket

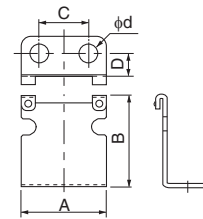

●Bracket

Product number	Applicable fitting product number	A (mm)	B (mm)	C (mm)	D (mm)	d (mm)
BRK4	ASU4	18.0	18.5	10.0	6.5	5.0
BRK6	ASU6	24.0	26.0	14.0	6.5	5.0
BRK8	ASU8	26.0	30.0	14.0	6.5	5.0

Reference

Technical
information

Jig/Tool/
Accessory

**Control switch/
Detachable
series**

Bamboo-
shoot fitting

Clean fitting/
Chemifit

QuickSeal
fitting

PushOne
fitting

Processed
tubing

Clean
tubing

Tubing

Ball Valve

PushOne™ Type

Features

- **Enables compacting piping**
Integrated space-saving ball valve and PushOne fitting enables compact piping.
- **PushOne connection of tubing**
Jig and tool not required for connecting the tubes.
- **Position of handle can be changed**
Handle can be re-attached in different position if it hits something when opened or closed.
- **Nickel plated**
Prevents degradation of surface and dissolution of copper ions into fluid.

Cross-sectional structure diagram

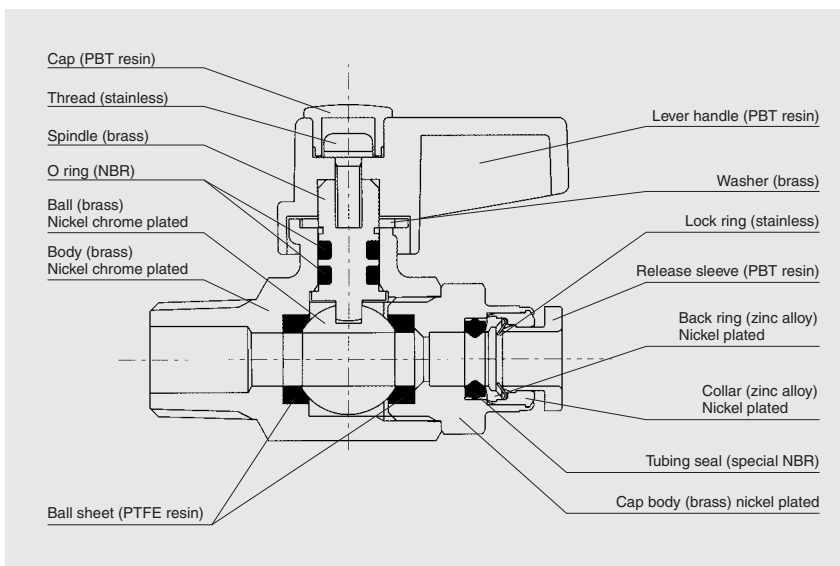

Product number example

VS-E6-F1/4

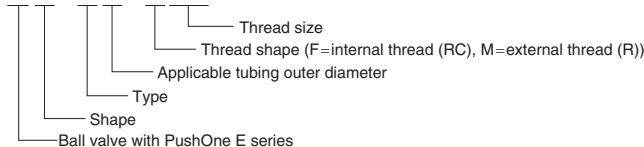

Applicable tubing

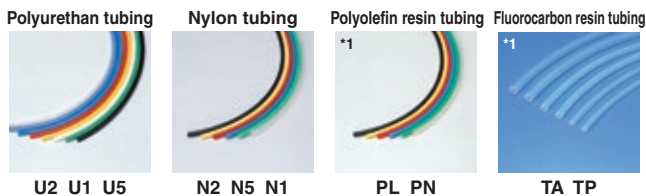

(*1) Combinatory use of PL, PN, TA or TP tubing and ball valve mixes general and clean type performances. When using them together in a clean environment, be aware of how this could lower the cleanliness level.



Operating fluid, working temperature range

Operating fluid	Working temperature range
Air	-20°C~+80°C
Water	-0°C~+40°C

Pressure condition

Maximum working pressure: 1.0MPa

Change of open/close position of handle

Position of the lever handle can be changed when the handle could be interfered with by any objects that would prevent it from opening or closing a full 90 degrees.

- ① Detach the cap and the thread inside.
- ② Detach the lever handle.
- ③ Attach the lever handle in new position at user's discretion, then confirm that the handle can be opened or closed smoothly a full 90 degrees before tightening up the thread.
- ④ Attach the cap again.

Handling instructions

- ⚠ **Caution:** When the working conditions of tubes and fittings differ, use them under the lower specified conditions.
- ⚠ **Caution:** When water is used as the operating fluid, do not allow it to freeze.
- ⚠ **Caution:** Use the valve at fully open or closed position, not at an intermediate position.
- ⚠ **Caution:** Do not bend the pipe sharply near the tubing insertion port (sleeve end) of the fitting. Keep the tubing straight for twice as long as the tubing diameter from the insertion port.
- ⚠ **Caution:** Cannot be used at a negative pressure.

📖 See page 134 for the common handling instructions for control, switch and detachable series products.

Straight type



●Internal thread

Product number	Applicable tubing outer diameter (mm)	T Thread size (RC)	L ₁ (mm)	L ₂ (mm)	L ₃ (mm)	L ₄ (mm)	LH (mm)	F Tubing insertion length (mm)	D ₁ (mm)	D ₂ (mm)	H (mm)	Effective sectional area (mm ²)	Weight (g)
VS-E6-F1/8	6	RC1/8	29.0	20.5	24.5	45.0	25.0	15	6.0	5.0	17	—	62.0
VS-E6-F1/4	6	RC1/4	29.0	22.5	24.5	47.0	25.0	15	6.0	5.0	17	—	66.0
VS-E8-F1/8	8	RC1/8	29.0	20.5	25.7	46.2	25.0	16	6.0	6.0	17	—	62.0
VS-E8-F1/4	8	RC1/4	29.0	22.5	25.7	48.2	25.0	16	6.0	6.0	17	—	66.0
VS-E8-F3/8	8	RC3/8	30.5	23.0	27.4	50.4	25.0	16	7.5	6.0	22	—	106.0
VS-E10-F1/4	10	RC1/4	29.0	22.5	28.5	51.0	25.0	19	6.0	6.0	17	—	70.0
VS-E10-F3/8	10	RC3/8	30.5	23.0	30.0	53.0	25.0	19	7.5	7.5	22	—	108.0
VS-E12-F3/8	12	RC3/8	30.5	23.0	32.3	55.3	25.0	20	7.5	7.5	22	—	110.0

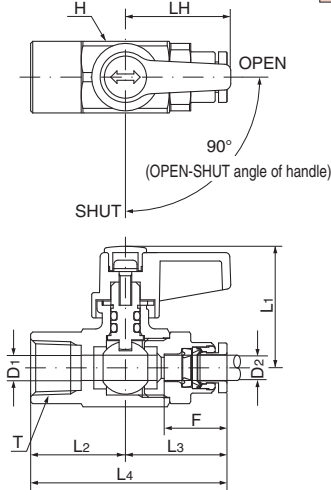

●External thread

Product number	Applicable tubing outer diameter (mm)	T Thread size (R)	L ₁ (mm)	L ₂ (mm)	L ₃ (mm)	L ₄ (mm)	LH (mm)	F Tubing insertion length (mm)	D ₁ (mm)	D ₂ (mm)	H (mm)	Effective sectional area (mm ²)	Weight (g)
VS-E6-M1/8	6	R1/8	29.0	20.5	24.5	45.0	25.0	15	6.0	5.0	17	—	58.0
VS-E6-M1/4	6	R1/4	29.0	22.5	24.5	47.0	25.0	15	6.0	5.0	17	—	61.0
VS-E8-M1/8	8	R1/8	29.0	20.5	25.7	46.2	25.0	16	6.0	6.0	17	—	58.0
VS-E8-M1/4	8	R1/4	29.0	22.5	25.7	48.2	25.0	16	6.0	6.0	17	—	61.0
VS-E8-M3/8	8	R3/8	30.5	23.0	27.4	50.4	25.0	16	7.5	6.0	22	—	100.0
VS-E8-M1/2	8	R1/2	30.5	24.0	27.4	51.4	25.0	16	7.5	6.0	22	—	108.0
VS-E10-M1/4	10	R1/4	29.0	22.5	28.5	51.0	25.0	19	6.0	6.0	17	—	65.0
VS-E10-M3/8	10	R3/8	30.5	23.0	30.0	53.0	25.0	19	7.5	7.5	22	—	102.0
VS-E10-M1/2	10	R1/2	30.5	24.0	30.0	54.0	25.0	19	7.5	7.5	22	—	110.0
VS-E12-M3/8	12	R3/8	30.5	23.0	32.3	55.3	25.0	20	7.5	7.5	22	—	104.0
VS-E12-M1/2	12	R1/2	30.5	24.0	32.3	56.3	25.0	20	7.5	7.5	22	—	112.0

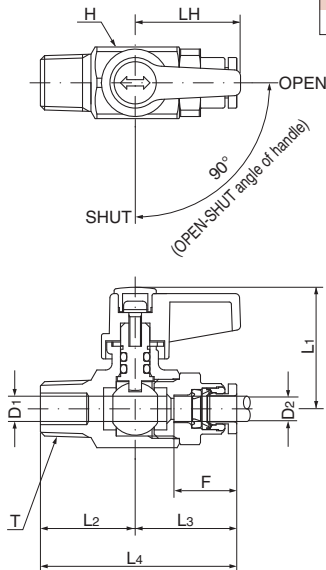

- Tubing
- Clean tubing
- Processed tubing
- PushOne fitting
- QuickSeal fitting
- Clean fitting/ Chemifit
- Bamboo-shoot fitting
- Control switch/ Detachable series
- Jig/Tool/ Accessory
- Technical information
- Reference

Angled type



●Internal thread

Product number	Applicable tubing outer diameter (mm)	T Thread size (RC)	L ₁ (mm)	L ₂ (mm)	L ₃ (mm)	L ₄ (mm)	LH (mm)	F Tubing insertion length (mm)	D ₁ (mm)	D ₂ (mm)	H (mm)	Effective sectional area (mm ²)	Weight (g)
VA-E6-F1/8	6	RC1/8	24.5	19.0	29.0	48.0	25.0	15	6.0	5.0	17	—	68.0
VA-E6-F1/4	6	RC1/4	24.5	21.0	29.0	50.0	25.0	15	6.0	5.0	17	—	65.0
VA-E8-F1/8	8	RC1/8	25.7	19.0	29.0	48.0	25.0	16	6.0	6.0	17	—	68.0
VA-E8-F1/4	8	RC1/4	25.7	21.0	29.0	50.0	25.0	16	6.0	6.0	17	—	65.0
VA-E8-F3/8	8	RC3/8	27.4	24.0	31.0	55.0	25.0	16	7.5	6.0	22	—	114.0
VA-E10-F1/4	10	RC1/4	28.5	21.0	29.0	50.0	25.0	19	6.0	6.0	17	—	69.0
VA-E10-F3/8	10	RC3/8	30.0	24.0	31.0	55.0	25.0	19	7.5	7.5	22	—	103.0
VA-E12-F3/8	12	RC3/8	32.3	24.0	31.0	55.0	25.0	20	7.5	7.5	22	—	118.0

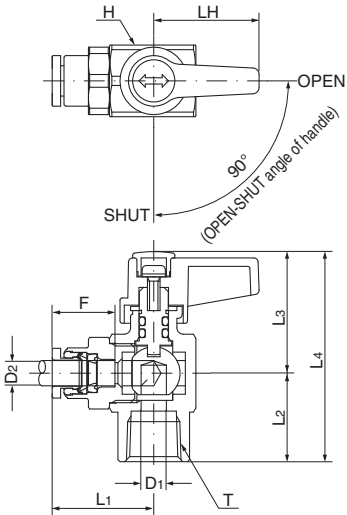

●External thread

Product number	Applicable tubing outer diameter (mm)	T Thread size (R)	L ₁ (mm)	L ₂ (mm)	L ₃ (mm)	L ₄ (mm)	LH (mm)	F Tubing insertion length (mm)	D ₁ (mm)	D ₂ (mm)	H (mm)	Effective sectional area (mm ²)	Weight (g)
VA-E6-M1/8	6	R1/8	24.5	20.0	29.0	49.0	25.0	15	6.0	5.0	17	—	61.0
VA-E6-M1/4	6	R1/4	24.5	21.0	29.0	50.0	25.0	15	6.0	5.0	17	—	64.0
VA-E8-M1/8	8	R1/8	25.7	20.0	29.0	49.0	25.0	16	6.0	6.0	17	—	61.0
VA-E8-M1/4	8	R1/4	25.7	21.0	29.0	50.0	25.0	16	6.0	6.0	17	—	64.0
VA-E8-M3/8	8	R3/8	27.4	25.0	31.0	56.0	25.0	16	7.5	6.0	22	—	110.0
VA-E10-M1/4	10	R1/4	28.5	21.0	29.0	50.0	25.0	19	6.0	6.0	17	—	68.0
VA-E10-M3/8	10	R3/8	30.0	25.0	31.0	56.0	25.0	19	7.5	7.5	22	—	112.0
VA-E12-M3/8	12	R3/8	32.3	25.0	31.0	56.0	25.0	20	7.5	7.5	22	—	106.0
VA-E12-M1/2	12	R1/2	32.3	27.0	31.0	57.0	25.0	20	9.0	7.5	22	—	113.0

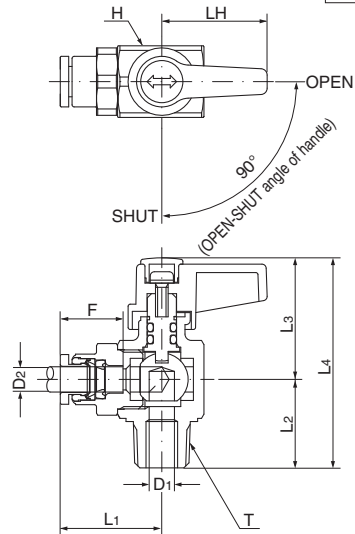

Tubing

Clean tubing

Processed tubing

PushOne fitting

QuickSeal fitting

Clean fitting/ChemiFit

Bamboo-shoot fitting

Control switch/Detachable series

Jig/Tool/Accessory

Technical information

Reference

Throttle Valve

PushOne™ Type

Features

- Fine control of flow rate
- Flame-resistant resin (compliant with V-0 of UL94 standard)
Made of flame-resistant resin PBT. High self-extinguishing performance is compliant with V-0 of UL94 standard. Usable under an environment with spatters.
- Inline type (ANU) allows central control on a pipe line
Various kinds of piping are possible by fixing with connector pins and brackets.
- PushOne connection of tubing
Jigs and tools are not required for connecting the tubes.
- Electroless nickel plated
Prevents degradation of the surface and dissolution of copper ions into fluid.
- Sealing-processed R thread
Sealing tape is not required.

Cross-sectional structure diagram

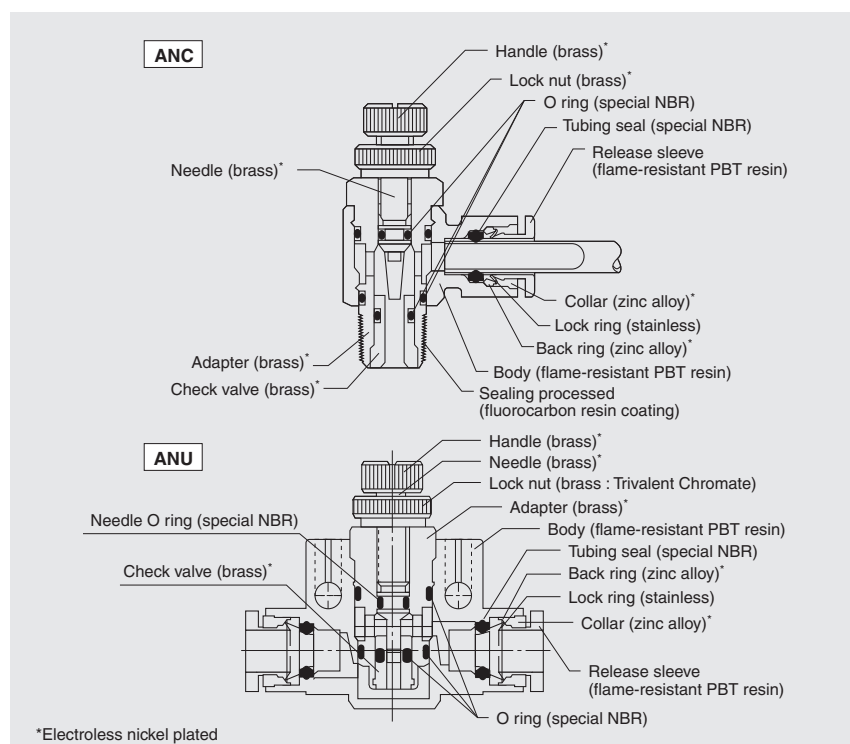

Product number example

ANC 6-R1/8

Shape
Applicable tubing outer diameter
Thread size

Distinction from speed controller



No arrow mark (left): Throttle valve
Arrow mark present (right): Speed controller

Applicable tubing



(*1) Combinatory use of PL, PN, TA or TP tubing and throttle valve mixes general and clean type performances. When using them together in a clean environment, be aware of how this could lower the cleanliness level.



Operating fluid, working temperature range

Operating fluid	Working temperature range
Air	-20°C~+80°C
Water	0°C~+40°C

Pressure condition

Maximum working pressure: 1.0MPa

Handling instructions

- ⚠ **Caution:** When the working conditions of tubes and fittings differ, use them under the lower specified conditions.
- ⚠ **Caution:** Tighten the lock nut and handle by hand, not by a spanner.
- ⚠ **Caution:** The needle part stops when fully opened. Forced rotation could cause damage.
- ⚠ **Caution:** When water is used as the operating fluid, do not allow it to freeze.
- ⚠ **Caution:** When water is used as the operating fluid, confirm that there is no water leakage damage to equipment and instruments due to construction failure.
- ⚠ **Caution:** Do not bend the pipe sharply near the tubing insertion port (sleeve end) of the fitting. Keep the tubing straight for twice as long as the tubing diameter from the insertion port.

👉 See page 134 for the common handling instructions for control, switch and detachable series products.

Inline type connection



Inline type controllers can be connected with a connector pin.
(The photograph shows speed controllers.)

Reference

UL-94 standard flame test.....P.195

Elbow type



●Millimeter size type

Product number	Applicable tubing outer diameter (mm)	Thread size (R)	L ₁ (mm)	L ₂ (mm)	L ₃ (mm)	K		A (mm)	F Tubing insertion length (mm)	H×φ Width across flat (mm)	N (mm)	M (mm)	D (mm)	D ₁ (mm)	Weight (g)
						Full open (mm)	Full closed (mm)								
ANC4-R1/8	4	R1/8	20.1	13.7	27.2	36.0	31.0	7.3	13.5	12.0×13.5	11.0	8.0	9.8	14.2	19.0
ANC6-R1/8	6	R1/8	21.8	13.7	28.9	36.0	31.0	7.3	15	12.0×13.5	11.0	8.0	12.6	14.2	20.0

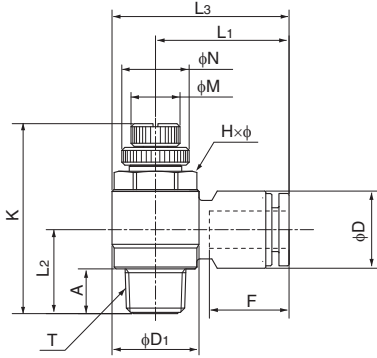

Inline type



●Millimeter size type

Product number	Applicable tubing outer diameter (mm)	L (mm)	L ₁ (mm)	L ₂ (mm)	P ₁ (mm)	P ₂ (mm)	K		F Tubing insertion length (mm)	N (mm)	M (mm)	D (mm)	d (mm)	W (mm)	Weight (g)	Effective sectional area (mm ²)
							Full open (mm)	Full closed (mm)								
ANU4	4	41.8	20.0	6.4	6.0	14.0	29.5	26.9	13	8.0	5.0	9.8	3.2	10.6	11.5	—
ANU6	6	47.6	28.0	9.0	8.2	20.0	43.5	39.8	15	11.0	8.0	12.6	4.2	15.0	31.0	—
ANU8	8	55.8	30.0	10.3	9.2	22.0	47.7	42.1	16	13.0	10.0	14.6	4.2	17.6	48.0	—

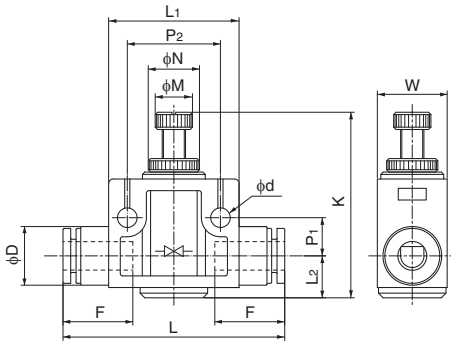

Connector pin

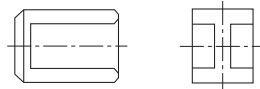

●Connector pin

Product number	Applicable fitting product number
HPN4	ANU4
HPN6	ANU6
	ANU8

Bracket

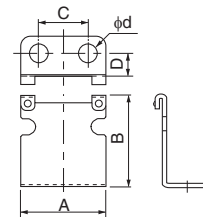

●Bracket

Product number	Applicable fitting product number	A (mm)	B (mm)	C (mm)	D (mm)	d (mm)
BRK4	ANU4	18.0	18.5	10.0	6.5	5.0
BRK6	ANU6	24.0	26.0	14.0	6.5	5.0
BRK8	ANU8	26.0	30.0	14.0	6.5	5.0

Miniature Valve

PushOne™ Type and QuickSeal Type

Features

- Easy flow rate control
Easy operation with large handle.
- Fine control of flow rate
Fine thread is used for valve system.
- PushOne connection for millimeter size type
Jigs and tools are not required for connecting the tubes.



Product number example

E MVB 6 - PT1/8

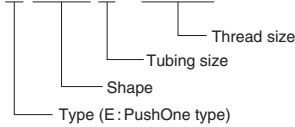

Q MVB 1N 1/4 - R1/8

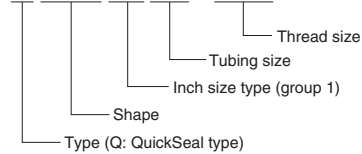

Operating fluid, working temperature range

Operating fluid	Working temperature range
Air	-20°C~+80°C
Water	0°C~+40°C

Pressure condition

Maximum working pressure: 1.0MPa
Negative pressure performance: -98.642kPa

Handling instructions

- ⚠ **Caution:** When the working conditions of tubes and fittings differ, use them under the lower specified conditions.
- ⚠ **Caution:** When water is used as the operating fluid, do not allow it to freeze.
- ⚠ **Caution:** Do not bend the pipe sharply near the tubing insertion port (sleeve end) of the fitting. Keep the tubing straight for twice as long as the tubing diameter from the insertion port.
- ⚠ **Caution:** The miniature valve has a determined flow direction, which is indicated on the side body. Flow fluid in the correct direction to control the flow rate.

📖 See page 134 for the common handling instructions for control, switch and detachable series products.

Applicable tubing

PushOne type (millimeter size)

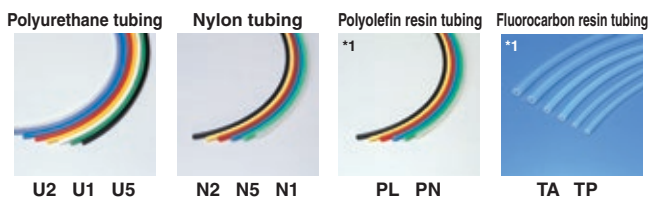

(*1) Combinatory use of PL, PN, TA or TP tubing and miniature valve mixes general and clean type performances. When using them together in a clean environment, be aware of how this could lower the cleanliness level.

QuickSeal type (Inch size)

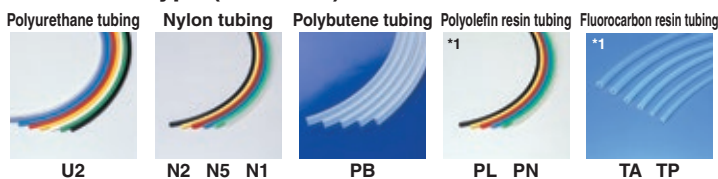

(*1) Combinatory use of PL, PN, TA or TP tubing and miniature valve mixes general and clean type performances. When using them together in a clean environment, be aware of how this could lower the cleanliness level.

Reference

Negative-pressure performance list.....P.169

Miniature Valve (PushOne™ type)

Inline type

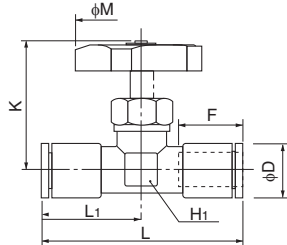

●Millimeter size type

Product number	Applicable tubing outer diameter (mm)	L (mm)	L ₁ (mm)	K		M (mm)	F Tubing insertion length (mm)	H ₁ Width across flat (mm)	D (mm)	Weight (g)	Effective sectional area (mm ²)
				Full open (mm)	Full closed (mm)						
EMVA6	6	50.6	25.3	39.9	35.9	40.0	15	15.0	15.0	—	—
EMVA8	8	51.6	25.8	39.9	35.9	40.0	16	15.0	15.0	86.0	2.5

Straight type

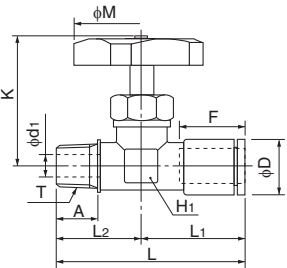

●Millimeter size type

Product number	Applicable tubing outer diameter (mm)	T Thread size (R)	L (mm)	L ₁ (mm)	L ₂ (mm)	A (mm)	K		M (mm)	F Tubing insertion length (mm)	H ₁ Width across flat (mm)	d ₁ (mm)	D (mm)	Weight (g)	Effective sectional area (mm ²)
							Full open (mm)	Full closed (mm)							
EMVB6-PT1/8	6	R1/8	46.8	25.3	21.5	10.0	39.9	35.9	40.0	15	15.0	5.0	15.0	81.0	3.5
EMVB6-PT1/4	6	R1/4	49.8	25.3	24.5	13.0	39.9	35.9	40.0	15	15.0	7.0	15.0	84.5	3.5
EMVB8-PT1/4	8	R1/4	50.3	25.8	24.5	13.0	39.9	35.9	40.0	16	15.0	7.0	15.0	—	—

Angled type

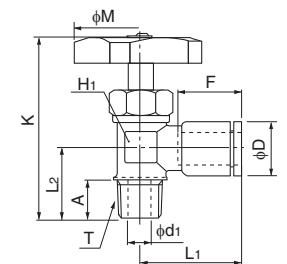

●Millimeter size type

Product number	Applicable tubing outer diameter (mm)	T Thread size (R)	L ₁ (mm)	L ₂ (mm)	A (mm)	K		M (mm)	F Tubing insertion length (mm)	H ₁ Width across flat (mm)	d ₁ (mm)	D (mm)	Weight (g)	Effective sectional area (mm ²)
						Full open (mm)	Full closed (mm)							
EMVC6-PT1/8	6	R1/8	25.3	23.0	12.0	57.9	53.9	40.0	15	15.0	5.0	15.0	76.5	7.0
EMVC6-PT1/4	6	R1/4	25.3	23.0	12.0	57.9	53.9	40.0	15	15.0	7.0	15.0	—	—
EMVC8-PT1/4	8	R1/4	24.8	23.0	12.0	57.9	53.9	40.0	16	15.0	7.0	15.0	78.0	7.0

Tubing

Clean tubing

Processed tubing

PushOne fitting

QuickSeal fitting

Clean fitting/Chemifit

Bamboo-shoot fitting

Control switch/Detachable series

Jig/Tool/Accessory

Technical information

Reference

Miniature Valve (QuickSeal type)

Inline type

●Inch size type



Product number	Applicable tubing outer diameter (inch)	L (mm)	L ₁ (mm)	K		M (mm)	S (mm)	F Tubing insertion length (mm)	H ₁ Width across flat (mm)	H ₂ (mm)	d ₂ (mm)	Weight (g)	Effective sectional area (mm ²)
				Full open (mm)	Full closed (mm)								
QMVA1N1/4	1/4	54.2	27.1	37.4	33.4	φ40.0	4.6	15	14.0	12.0	3.4	80.0	5.0
QMVA1N3/8	3/8	62.6	31.3	38.9	34.9	φ40.0	4.6	17	17.0	17.0	5.7	117.0	6.0

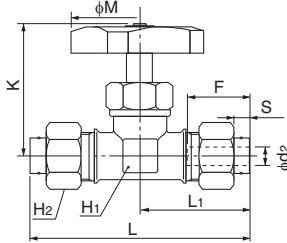

Straight type

●Inch size type



Product number	Applicable tubing outer diameter (inch)	T Thread size (R)	L (mm)	L ₁ (mm)	L ₂ (mm)	A (mm)	K		M (mm)	S (mm)	F Tubing insertion length (mm)	H ₁ Width across flat (mm)	H ₂ (mm)	d ₁ (mm)	d ₂ (mm)	Weight (g)	Effective sectional area (mm ²)
							Full open (mm)	Full closed (mm)									
QMVB1N1/4-R1/8	1/4	R1/8	46.6	27.1	19.5	10.0	37.4	33.4	φ40.0	4.6	15	14.0	12.0	5.0	3.4	76.0	5.0
QMVB1N1/4-R1/4	1/4	R1/4	48.6	27.1	21.5	12.0	37.4	33.4	φ40.0	4.6	15	14.0	12.0	7.0	3.4	95.0	5.5
QMVB1N3/8-R1/4	3/8	R1/4	56.3	31.3	25.0	12.0	38.9	34.9	φ40.0	4.6	17	17.0	17.0	7.0	5.7	113.0	6.0

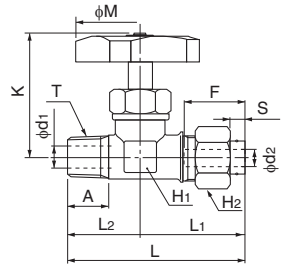

Angled type

●Inch size type



Product number	Applicable tubing outer diameter (inch)	T Thread size (R)	L ₁ (mm)	L ₂ (mm)	A (mm)	K		M (mm)	S (mm)	F Tubing insertion length (mm)	H ₁ Width across flat (mm)	H ₂ (mm)	d ₁ (mm)	d ₂ (mm)	Weight (g)	Effective sectional area (mm ²)
						Full open (mm)	Full closed (mm)									
QMVC1N1/4-R1/8	1/4	R1/8	27.1	20.0	10.0	54.9	50.9	φ40.0	4.6	15	14.0	12.0	5.0	3.4	75.0	—
QMVC1N1/4-R1/4	1/4	R1/4	27.1	22.0	12.0	56.9	50.9	φ40.0	4.6	15	14.0	12.0	7.0	3.4	92.0	7.0
QMVC1N3/8-R1/4	3/8	R1/4	28.3	23.0	12.0	59.9	55.9	φ40.0	4.6	17	17.0	17.0	7.0	5.7	104.0	7.0

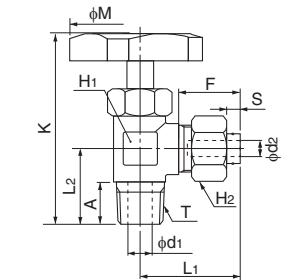

Tubing
Clean tubing
Processed tubing
PushOne fitting
QuickSeal fitting
Clean fitting/Chemifit
Bamboo-shoot fitting
Control switch/Detachable series
Jig/Tool/Accessory
Technical information
Reference

Valve Built-in Connector

PushOne™ Type

Features

- Valve inside fitting is opened/closed by attaching/detaching tubing
The valve is automatically closed by detaching the tubing.
- PushOne connection of tubing
Jigs and tools are not required for connecting the tubes.
- Electroless nickel plated
Prevents degradation of surface and dissolution of copper ions into fluid.
- Sealing-processed R thread
Sealing tape is not required.

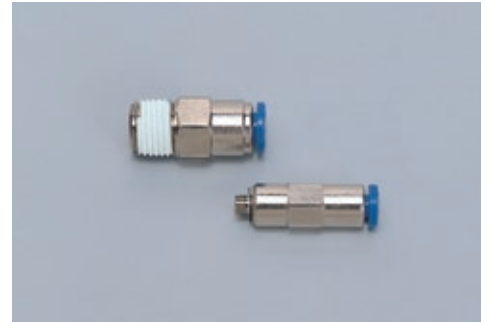

Cross-sectional structure diagram

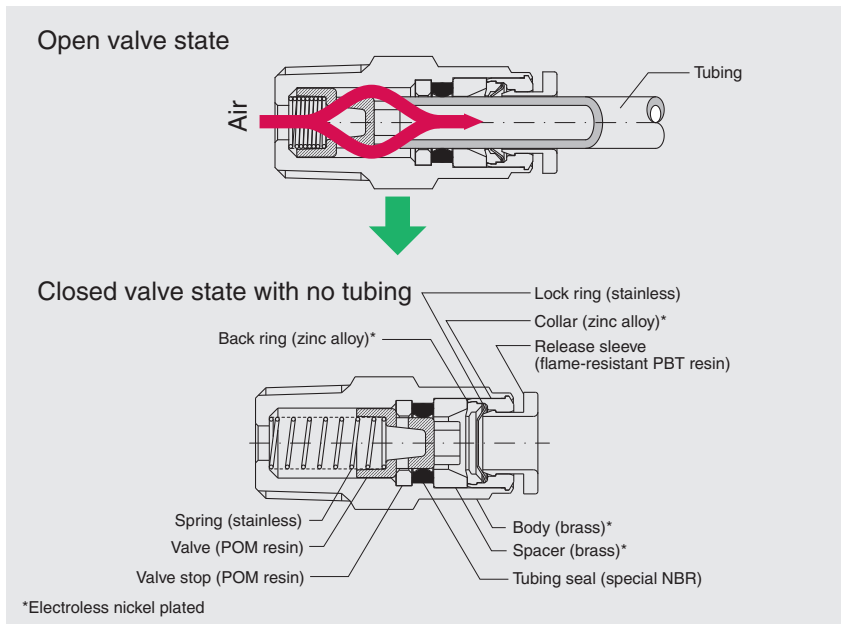

Operating fluid, working temperature range

Operating fluid	Working temperature range
Air	+20°C~+60°C

Pressure condition

Maximum working pressure: 1.0MPa

Handling instructions

- ⚠ **Caution:** When the working conditions of tubes and fittings differ, use them under the lower specified conditions.
- ⚠ **Caution:** Cannot be used at a negative pressure.
- ⚠ **Caution:** Detach tubing when it is unpressurized.
- ⚠ **Caution:** Do not bend the pipe sharply near the tubing insertion port (sleeve end) of the fitting. Keep the tubing straight for twice as long as the tubing diameter from the insertion port.
- ⚠ **Caution:** Reducers, adapter elbows and Y-plugs of PushOne series cannot be used.

📖 See page 134 for the common handling instructions for control, switch and detachable series products.

Applicable tubing

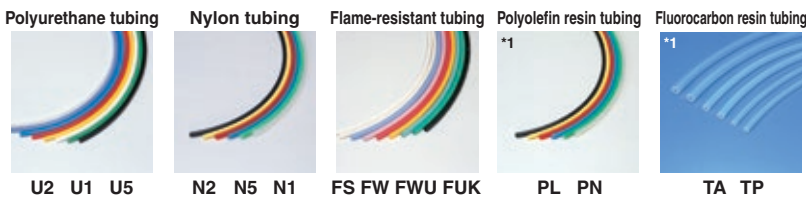

(*1) Combinatory use of PL, PN, TA or TP tubing and valve built-in connector mixes general and clean type performances.
When using them together in a clean environment, be aware of how this could lower the cleanliness level.

Connector

●Millimeter size type



Product number	Applicable tubing outer diameter (mm)	T Thread size (M,R)	L (mm)	A (mm)	F Tubing insertion length (mm)	H×φ Width across flat (mm)	D (mm)	d ₁ (mm)	Weight (g)	Effective sectional area (mm ²)
ECV4-M5	4	M5×0.8	32.6	4.0	16	10.0×11.0	10.0	2.0	11.0	2.0
ECV6-PT1/8	6	R1/8	40.4	8.0	17	14.0×15.4	13.0	4.0	26.0	6.5
ECV6-PT1/4	6	R1/4	31.4	11.0	17	14.0×15.4	13.0	4.0	21.0	6.5

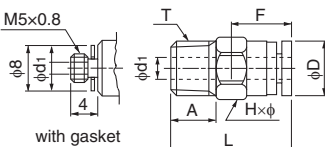

Q.D.C. 101 Series

Compact coupler for air pressure

Features

- **Push-To-Connect type**
One-touch connection just by pushing the nipple into the coupler.
- **Automatic opening/closing valve inside the coupler**
The valve inside the coupler is automatically opened by connecting the coupler and the nipple.
- SUS304 type (made to order) available
- PushOne fitting integrated types available



Cross-sectional structure diagram

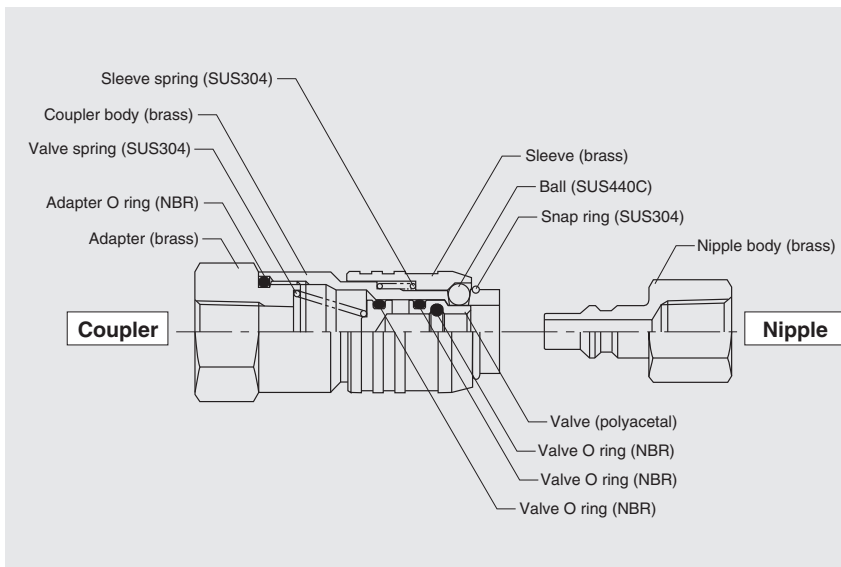

Operating fluid, working temperature range

Operating fluid	Working temperature range
Air	-20°C~+80°C

Pressure condition

Maximum working pressure: 1.0MPa
Negative pressure performance: -99.975kPa

Handling instructions

- ⚠ **Caution:** When the working conditions of tubes and fittings are different, use them under the lower specified conditions.
- ⚠ **Caution:** Neither the coupler nor nipple can be connected to other manufacturers' products.
- ⚠ **Caution:** Detach the tubing, coupler or nipple in an unpressurized state.
- ⚠ **Caution:** Do not use and rotate the coupler as a substitute for a rotary joint or swivel joint.
- ⚠ **Caution:** Do not use the coupler or nipple in a place contaminated with metal particles or dust. It could cause problems with operation.
- ⚠ **Caution:** Connection and disconnection under a residual pressure may cause an accident. Also, do not hit the front end with a hammer to release pressure.
- ⚠ **Caution:** In case of leakage due to abrasion or degradation of O ring, replace both the O ring and body with new ones.

👉 See page 134 for the common handling instructions for control, switch and detachable series products.

Product number example

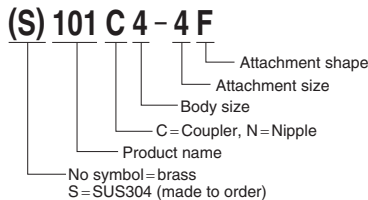

Coupler

PushOne™ type

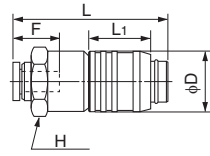

Product number	Applicable tubing outer diameter (mm)	L (mm)	L1 (mm)	F Tubing insertion length (mm)	H Width across flat (mm)	D (mm)	Weight (g)
101C4-6E	6	49.3	19.5	15	19.0	19.0	62.0
101C4-8E	8	50.9	19.5	16	19.0	19.0	62.0
101C4-10E	10	53.9	19.5	19	19.0	19.0	64.5

Internal thread type

Brass type



Stainless type

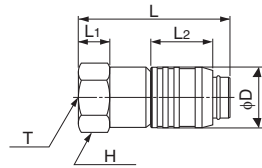

Product number	T Thread size (RC)	L (mm)	L1 (mm)	L2 (mm)	H Width across flat (mm)	D (mm)	Weight (g)
101C4-2F	RC1/8	48.0	10.0	19.5	19.0	19.0	67.5
101C4-4F	RC1/4	48.0	10.0	19.5	19.0	19.0	60.5
* S101C4-2F	RC1/8	48.0	10.0	19.5	19.0	19.0	67.5
* S101C4-4F	RC1/4	48.0	10.0	19.5	19.0	19.0	60.5

*Made to order

External thread type

Brass type



Stainless type

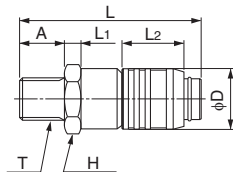

Product number	T Thread size (R)	L (mm)	A (mm)	L1 (mm)	L2 (mm)	H Width across flat (mm)	D (mm)	Weight (g)
101C4-2M	R1/8	53.5	10.0	5.5	19.5	19.0	19.0	59.0
101C4-4M	R1/4	57.5	14.0	5.5	19.5	19.0	19.0	64.0
* S101C4-2M	R1/8	53.5	10.0	5.5	19.5	19.0	19.0	59.0
* S101C4-4M	R1/4	57.5	14.0	5.5	19.5	19.0	19.0	64.0

*Made to order

N2-1-1/4 type



Product number : 101C4-4T

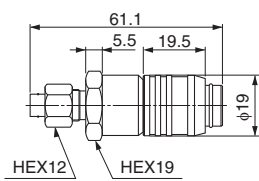

Weight : 64.0g

Nylon coil tubing S1/4 type



Product number : 101C4-4S

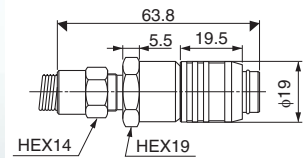

Weight : 78.5g

φ8 hose type



Product number : 101C4-4H

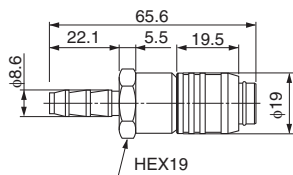

Weight : 63.5g

Tubing

Clean tubing

Processed tubing

PushOne fitting

QuickSeal fitting

Clean fitting/Chemifit

Bamboo-shoot fitting

Control switch/Detachable series

Jig/Tool/Accessory

Technical information

Reference

Nipple

PushOne™ type

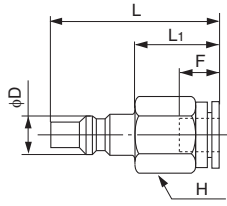

Product number	Applicable tubing outer diameter (mm)	L (mm)	L ₁ (mm)	F Tubing insertion length (mm)	H Width across flat (mm)	D (mm)	Weight (g)
101N4-6E	6	32.8	16.2	15	12.0	8.3	13.0
101N4-8E	8	34.9	18.3	16	14.0	8.3	16.0
101N4-10E	10	38.4	21.8	19	17.0	8.3	27.0

Internal thread type

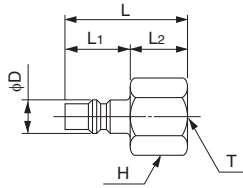

Product number	T Thread size (RC)	L (mm)	L ₁ (mm)	L ₂ (mm)	H Width across flat (mm)	D (mm)	Weight (g)
101N4-2F	RC1/8	29.5	16.6	12.9	14.0	8.3	16.5
101N4-4F	RC1/4	32.8	16.6	16.2	17.0	8.3	25.0
* S101N4-2F	RC1/8	29.5	16.6	12.9	14.0	8.3	16.5
* S101N4-4F	RC1/4	32.8	16.6	16.2	17.0	8.3	25.0

*Made to order

External thread type

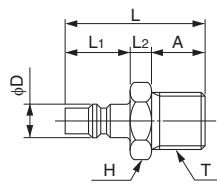

Product number	T Thread size (R)	L (mm)	L ₁ (mm)	L ₂ (mm)	A (mm)	H Width across flat (mm)	D (mm)	Weight (g)
101N4-2M	R1/8	31.4	16.6	4.8	10.0	14.0	8.3	13.5
101N4-4M	R1/4	35.4	16.6	4.8	14.0	14.0	8.3	18.0
* S101N4-2M	R1/8	31.4	16.6	4.8	10.0	14.0	8.3	13.5
* S101N4-4M	R1/4	35.4	16.6	4.8	14.0	14.0	8.3	18.0

*Made to order

N2-1-1/4 type

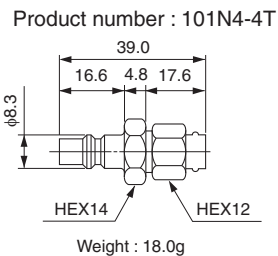

Nylon coil tubing S1/4 type

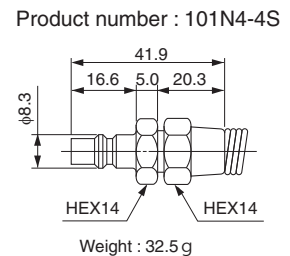

φ8 hose type

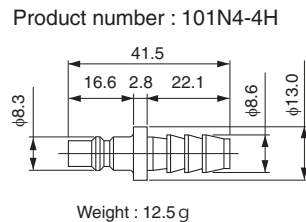

Tubing
Clean tubing
Processed tubing
PushOne fitting
QuickSeal fitting
Clean fitting/Chemifit
Bamboo-shoot fitting
Control switch/Detachable series
Jig/Tool/Accessory
Technical information
Reference

Q.D.C. 103 Series

Micro size coupler for air and oil pressure

Features

- **Push-To-Connect type**
One-touch connection just by pushing the nipple into the coupler.
- **Automatic opening/closing valve inside the coupler**
The valve inside the coupler is automatically opened by connecting the coupler and the nipple.
- **Smaller than 101 series**
Bamboo-shoot fitting integrated type available for direct connection to U5 tubing.
- **Electroless nickel plated**
Prevents degradation of surface and dissolution of copper ions into fluid.

Cross-sectional structure diagram

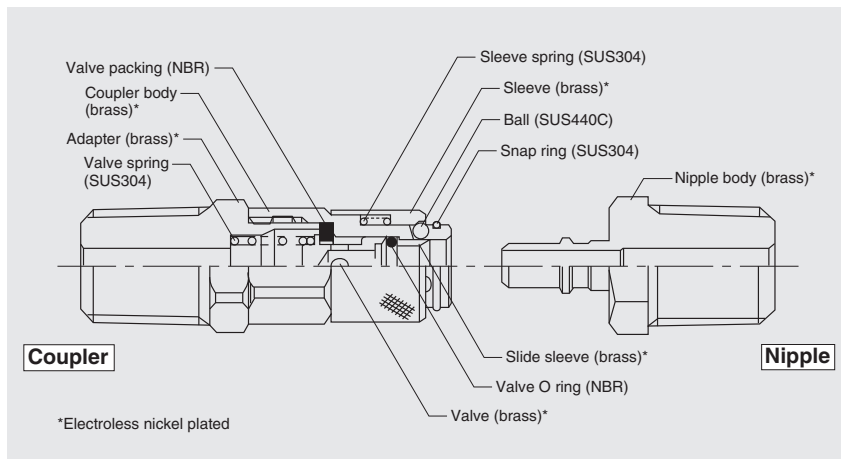

Operating fluid, working temperature range

Operating fluid	Working temperature range
Air	-20°C~+80°C
Water	0°C~+80°C
General operating oil	-20°C~+80°C

Pressure condition

Maximum working pressure: 1.0MPa
Negative pressure performance: -99.975kPa

Handling instructions

- ⚠ **Caution:** When working conditions of tubes and fittings are different, use them under the lower specified conditions.
- ⚠ **Caution:** Neither the coupler nor nipple can be connected to other manufacturers' products.
- ⚠ **Caution:** Detach the tubing, coupler or nipple in an unpressurized state.
- ⚠ **Caution:** Do not use and rotate coupler as a substitute for rotary joint or swivel joint.
- ⚠ **Caution:** When water is used as the operating fluid, do not allow it to freeze.
- ⚠ **Caution:** Do not use the coupler or nipple in a place contaminated with metal particles or dust. It could cause problems with operation.
- ⚠ **Caution:** Connection and disconnection under residual pressure may cause an accident. Also, do not hit the front end with a hammer to release pressure.
- ⚠ **Caution:** In case of leakage due to abrasion or degradation of O ring, replace both the O ring and body with new ones.

👉 See page 134 for the common handling instructions for the control, switch and detachable series products.

Product number example

103 C - M5

Attachment shape and size
C=Coupler, N=Nipple
Product name

Coupler

Connector type

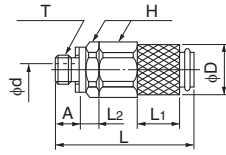

Product number	T Thread size (M)	L (mm)	L ₁ (mm)	L ₂ (mm)	A (mm)	H Width across flat (mm)	D (mm)	d (mm)	Weight (g)
103C-M5	M5x0.8	25.0	8.0	2.5	4.0	9.0	9.5	2.5	8.0

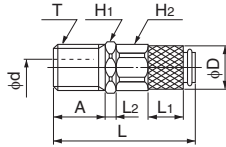

Product number	T Thread size (R)	L (mm)	L ₁ (mm)	L ₂ (mm)	A (mm)	H ₁ Width across flat (mm)	H ₂ Width across flat (mm)	D (mm)	d (mm)	Weight (g)
103C-2M	R1/8	31.0	8.0	3.0	11.0	10.0	9.0	9.5	3.0	13.0

Elbow type

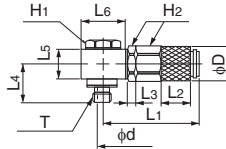

Product number	T Thread size (M)	L ₁ (mm)	L ₂ (mm)	L ₃ (mm)	L ₄ (mm)	L ₅ (mm)	L ₆ (mm)	H ₁ Width across flat (mm)	H ₂ Width across flat (mm)	D (mm)	d (mm)	Weight (g)
103C-M5UL	M5x0.8	26.0	8.0	2.5	10.0	8.0	12.0	8.0	9.0	9.5	2.0	15.0

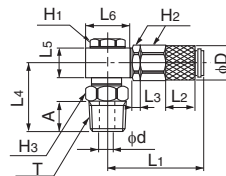

Product number	T Thread size (R)	L ₁ (mm)	L ₂ (mm)	L ₃ (mm)	L ₄ (mm)	L ₅ (mm)	L ₆ (mm)	A (mm)	H ₁ Width across flat (mm)	H ₂ Width across flat (mm)	H ₃ Width across flat (mm)	D (mm)	d (mm)	Weight (g)
103C-2MUL	R1/8	26.0	8.0	2.5	19.0	8.0	12.0	8.5	8.0	9.0	10.0	9.5	4.2	21.0

U5-tubing dedicated barb type

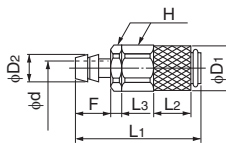

Product number	Applicable tubing type	L ₁ (mm)	L ₂ (mm)	L ₃ (mm)	F (mm)	H Width across flat (mm)	D ₁ (mm)	D ₂ (mm)	d (mm)	Weight (g)
103C-25H	U5-4x2.5	26.0	8.0	2.5	6.5	9.0	9.5	3.5	1.5	7.5
103C-40H	U5-4-6x4	27.5	8.0	2.5	8.0	9.0	9.5	5.7	3.0	8.0

U5-tubing dedicated barb elbow type

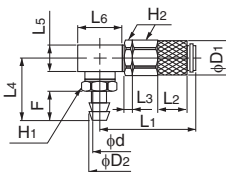

Product number	Applicable tubing type	L ₁ (mm)	L ₂ (mm)	L ₃ (mm)	L ₄ (mm)	L ₅ (mm)	L ₆ (mm)	F (mm)	H ₁ Width across flat (mm)	H ₂ Width across flat (mm)	D ₁ (mm)	D ₂ (mm)	d (mm)	Weight (g)
103C-25HL	U5-4-4x2.5	26.0	8.0	2.5	16.0	8.0	12.0	6.5	8.0	9.0	9.5	3.5	1.5	15.0
103C-40HL	U5-4-6x4	26.0	8.0	2.5	17.5	8.0	12.0	8.0	8.0	9.0	9.5	5.7	3.0	15.5

Tubing
Clean tubing
Processed tubing
PushOne fitting
QuickSeal fitting
Clean fitting/Chemifit
Bamboo-shoot fitting
Control switch/Detachable series
Jig/Tool/Accessory
Technical information
Reference

Nipple

Connector type

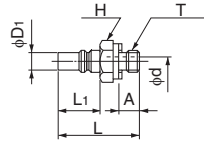

Product number	T Thread size (M)	L (mm)	L ₁ (mm)	A (mm)	H Width across flat (mm)	D ₁ (mm)	d (mm)	Weight (g)
103N-M5	M5x0.8	17.5	9.0	4.0	8.0	3.5	2.5	2.5

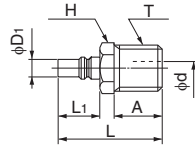

Product number	T Thread size (R)	L (mm)	L ₁ (mm)	A (mm)	H Width across flat (mm)	D ₁ (mm)	d (mm)	Weight (g)
103N-2M	R1/8	23.0	9.0	11.0	10.0	3.5	3.0	8.0

Elbow type

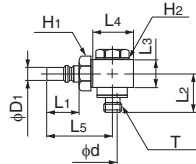

Product number	T Thread size (M)	L ₁ (mm)	L ₂ (mm)	L ₃ (mm)	L ₄ (mm)	L ₅ (mm)	H ₁ Width across flat (mm)	H ₂ Width across flat (mm)	D ₁ (mm)	d (mm)	Weight (g)
103N-M5UL	M5x0.8	9.0	10.0	8.0	12.0	18.5	8.0	8.0	3.5	2.0	9.5

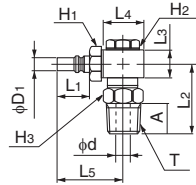

Product number	T Thread size (R)	L ₁ (mm)	L ₂ (mm)	L ₃ (mm)	L ₄ (mm)	L ₅ (mm)	A (mm)	H ₁ Width across flat (mm)	H ₂ Width across flat (mm)	H ₃ Width across flat (mm)	D ₁ (mm)	d (mm)	Weight (g)
103N-2MUL	R1/8	9.0	19.0	8.0	12.0	18.5	8.5	8.0	8.0	10.0	3.5	4.2	15.5

U5-tubing dedicated barb type

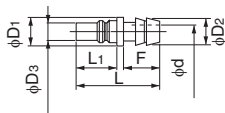

Product number	Applicable tubing type	L (mm)	L ₁ (mm)	F (mm)	D ₁ (mm)	D ₂ (mm)	D ₃ (mm)	d (mm)	Weight (g)
103N-25H	U5-4-4x2.5	17.0	9.0	6.5	6.0	3.5	3.5	1.5	1.0
103N-40H	U5-4-6x4	18.5	9.0	8.0	6.0	5.7	3.5	3.0	1.5

U5-tubing dedicated barb elbow type

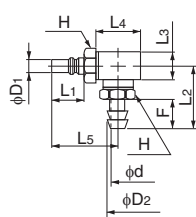

Product number	Applicable tubing type	L ₁ (mm)	L ₂ (mm)	L ₃ (mm)	L ₄ (mm)	L ₅ (mm)	F (mm)	H Width across flat (mm)	D ₁ (mm)	D ₂ (mm)	d (mm)	Weight (g)
103N-25HL	U5-4-4x2.5	9.0	16.0	8.0	12.0	18.5	6.5	8.0	3.5	3.5	1.5	9.5
103N-40HL	U5-4-6x4	9.0	17.5	8.0	12.0	18.5	8.0	8.0	3.5	5.7	3.0	10.0

Tubing

Clean tubing

Processed tubing

PushOne fitting

QuickSeal fitting

Clean fitting/Chemifit

Bamboo-shoot fitting

Control switch/Detachable series

Jig/Tool/Accessory

Technical information

Reference

Jigs, Tools and Accessories

INDEX

Tube Cutter



Hose Cutter



FW Tubing Outer Cover Peeling Cutter



FWU Tubing Outer Cover Peeling Cutter



Spatter Cap

For protection of the PushOne connection part from spatter, etc.



Tubing Removing jig



Tube Reel



Tubing

Clean tubing

Processed tubing

PushOne fitting

QuickSeal fitting

Clean fitting/
Chemifit

Bamboo-shoot fitting

Control switch/
Detachable series

Jig/Tool/
Accessory

Technical information

Reference

Tube Cutter

TC04



Features

- Compact, handy-to-carry, lightweight tubing cutter.
- Only the blade needs changing. It comes with three spare blades.
- Tubes up to 16mm diameter can be cut.

Applicable tubing size

Tubing outer diameter : ~16mm (5/8inch)

Handling instructions

- ⚠ **Warning:** Do not touch the cutter blade. It is sharp and may cut your fingers.
- ⚠ **Caution:** TC04 is developed for cutting resin tubes only. Do not use it for other purposes.
- ⚠ **Caution:** Do not put it in your pocket, etc. It may cause an accident if the blade is open.

TC01



Features

- Highly durable nipper-type tubing cutter.
- Tubes up to 13mm diameter can be cut.

Applicable tubing size

Tubing outer diameter : ~13mm (1/2inch)

Handling instructions

- ⚠ **Warning:** Do not touch the cutter blade. It is sharp and may cut your fingers.
- ⚠ **Caution:** TC01 is developed for cutting resin tubes. Do not use it for other purposes.

Hose Cutter

HC03



Features

- Highly durable nipper-type tubing cutter.
- Tubes up to 20mm diameter can be cut.

Applicable tubing size

Tubing outer diameter : ~20mm (3/4inch)

👉 Use hose cutter HC01 to cut a tubing of size 20-40mm.

Handling instructions

- ⚠ **Warning:** Do not touch the cutter blade. It is sharp and may cut your fingers.
- ⚠ **Caution:** HC03 is developed for cutting resin tubes. Do not use it for other purposes.

FW Tubing Outer Cover Peeling Cutter

TC02 • TC03



Features

- Easy peeling of FW tubing outer cover.

Applicable tubing size

Product number	Applicable tubing type
TC02	FW-4-6×4, FW-4-8×6
TC03	FW-4-10×7.5, FW-4-12×9

Handling instructions

- ⚠ **Warning:** Do not touch the cutter blade. It is sharp and may cut your fingers.
- ⚠ **Caution:** TC02 and TC03 are developed only for peeling the outer cover of FW tubes. Do not use them for other purposes, because doing so may cause an accident.

Reference

- Instruction manual.....P.183

FWU Tubing Outer Cover Peeling Cutter

TC02U • TC03U



Features

- Easy peeling of FWU tubing outer cover.

Applicable tubing size

Product number	Applicable tubing type
TC02U	FWU-4-6×4, FWU-4-8×5
TC03U	FWU-4-10×6.5, FWU-4-12×8

Handling instructions

- ⚠ **Warning:** Do not touch the cutter blade. It is sharp and may cut your fingers.
- ⚠ **Caution:** TC02U and TC03U are developed only for peeling the outer cover of FWU tubes. Do not use them for other purposes, because doing so may cause an accident.

Reference

- Instruction manual.....P.183

Tubing

Clean tubing

Processed tubing

PushOne fitting

QuickSeal fitting

Clean fitting/Chemifit

Bamboo-shoot fitting

Control switch/Detachable series

Jig/Tool/Accessory

Technical information

Reference

Spatter Cap

CP • CPFW



CPP (Attachable after piping)



Features

- Protecting PushOne connecting part from spatter, etc.
- CCP can be attached after connecting tubing.

Specification

Specification	Product number	Applicable tubing outer diameter (mm)	Applicable tubing type
Attachment before tubing piping	CP4	4	FUK•FS
	CP6	6	
	CP8	8	
	CP10	10	
	CP12	12	
Attachment after tubing piping	CPFW6	6	FW•FWU
	CPFW8	8	
	CPFW10	10	
	CPFW12	12	
Attachment after tubing piping	CPP6	6	FUK•FS•FW•FWU
	CPP8	8	
	CPP10	10	
	CPP12	12	

Reference

- Instruction manual.....P.186

Tubing Removing Jig (Off Tool)

EOT 6-4

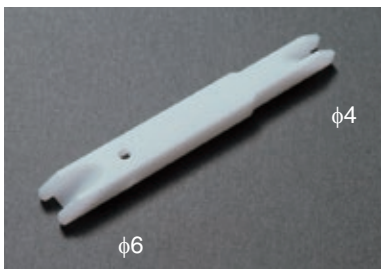

Features

- Helps removing tubing from PushOne.

Applicable tube size

Tubing with outer diameter : $\phi 4$, $\phi 6$

Reference

- Instruction manual.....P.187

Tube Reel

PTR

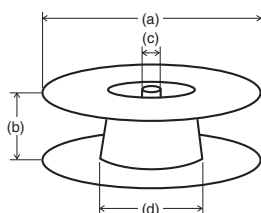
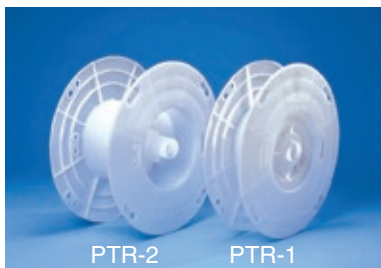

Features

- Easy handling.
- Recycled polypropylene resin used.

Specification

Product number	Applicable tubing size	Size (mm)				Weight (g)
		(a) Collar width	(b) Reel width	(c) Shaft width	(d) Reel body diameter	
PTR-1	Millimeter size: $\phi 4$, 6, 8	(a)	(b)	(c)	(d)	1030
	Inch size : $\phi 1/8$, 1/4, 5/16	480×105×50×225				
PTR-2	Millimeter size: $\phi 10$, 12	(a)	(b)	(c)	(d)	1170
	Inch size : $\phi 3/8$, 1/2	480×210×50×225				

☞ PTR tube reels are only for nylon tubes manufactured by Nitta. For other products, please check the actual information available for those items regarding any accessories.

Handling instructions

- ⚠ **Caution:** The tube reel cannot be used with other manufacturers' tubes.
- ⚠ **Caution:** The tube reel is made of resin and may be cracked if dropped or hit hard. Careful handling is required.
- ⚠ **Caution:** You may need to widen the inner drum to set a tubing if the wound tubing bundle is deformed.

Reference

- Instruction manual.....P.184

Tubing

Clean tubing

Processed tubing

PushOne fitting

QuickSeal fitting

Clean fitting/Chemifit

Bamboo-shoot fitting

Control switch/Detachable series

Jig/Tool/Accessory

Technical information

Reference

Technical Information

INDEX

Speed Controller Flow Rate Characteristics

Compact speed controller	P.163
Chemifit™ C1 speed controller	P.165
Speed controller	P.167

Effective sectional Area	P.168
--------------------------	-------

Negative Pressure Performance List	P.169
------------------------------------	-------

Instruction Manual

PushOne™ series	P.170
QuickSeal series	P.172
Chemifit™ C1 series	P.174
Chemifit™ C1S series	P.176
Chemifit™ CSE series	P.178
Chemifit™ CP series	P.180
Q.D.C 101 series	P.182
Q.D.C 103 series	P.182
FW/FWU tubing outer cover peeling cutter	P.183
Tube reel	P.184
Spatter Cap	P.186
Off tool	P.187

Tubing

Clean tubing

Processed tubing

PushOne fitting

QuickSeal fitting

Clean fitting/
Chemifit

Bamboo-
shoot fitting

Control switch/
Detachable series

Jig/Tool/
Accessory

Technical information

Reference

Speed Controller Flow Rate Characteristics

Compact Speed Controller (elbow type)

Product number	Controlled flow	Free flow
ASC4-M5-★ ASC6-M5-★		
ASC4-R1/8-★		
ASC6-R1/8-★ ASC8-R1/8-★ ASC10-R1/8-★		
ASC6-R1/4-★		
ASC8-R1/4-★ ASC10-R1/4-★		

“★” is either \bar{O} (meter-out) or I (meter-in).

Tubing

Clean tubing

Processed tubing

PushOne fitting

QuickSeal fitting

Clean fitting/
Chemifit

Bamboo-shoot fitting

Control switch/
Detachable series

Jig/Tool/
Accessory

Technical information

Reference

Compact Speed Controller (elbow type)

Product number	Controlled flow	Free flow
ASC8-R3/8-★		
ASC10-R3/8-★ ASC12-R3/8-★		
ASC10-R1/2-★		
ASC12-R1/2-★		

“★” is either \bar{O} (meter-out) or I (meter-in).

- Tubing
- Clean tubing
- Processed tubing
- PushOne fitting
- QuickSeal fitting
- Clean fitting/ Chemifit
- Bamboo-shoot fitting
- Control switch/ Detachable series
- Jig/Tool/ Accessory
- Technical information
- Reference

Chemifit™ C1 Speed Controller (elbow type)

Product number	Controlled flow	Free flow
ESC4-R1/8-O-C1SG ESC6-R1/8-O-C1SG ESC8-R1/8-O-C1SG		
ESC6-R1/4-O-C1SG ESC8-R1/4-O-C1SG ESC10-R1/4-O-C1SG		
ESC8-R3/8-O-C1SG ESC10-R3/8-O-C1SG ESC12-R3/8-O-C1SG		

Tubing

Clean tubing

Processed tubing

PushOne fitting

QuickSeal fitting

Clean fitting/Chemifit

Bamboo-shoot fitting

Control switch/Detachable series

Jig/Tool/Accessory

Technical information

Reference

Chemifit™ C1 Speed Controller (inline type)

Product number	Controlled flow	Free flow
ESU4-C1SG		
ESU6-C1SG		
ESU8-C1SG		

- Tubing
- Clean tubing
- Processed tubing
- PushOne fitting
- QuickSeal fitting
- Clean fitting/ Chemifit
- Bamboo-shoot fitting
- Control switch/ Detachable series
- Jig/Tool/ Accessory
- Technical information
- Reference

Speed Controller (inline type)

Product number	Controlled flow	Free flow
ASU4	<p>Graph showing Flow rate (l/min.(ANR)) vs Number of needle rotations (times) for ASU4. The y-axis ranges from 0 to 100, and the x-axis ranges from 0 to 10. Five curves represent pressures of 0.1MPa, 0.3MPa, 0.5MPa, 0.7MPa, and 0.9MPa. The flow rate increases with the number of rotations and plateaus at higher pressures.</p>	<p>Graph showing Flow rate (l/min.(ANR)) vs Pressure (MPa) for ASU4. The y-axis ranges from 0 to 100, and the x-axis ranges from 0 to 0.9. A single linear curve shows a direct proportionality between pressure and flow rate.</p>
ASU6	<p>Graph showing Flow rate (l/min.(ANR)) vs Number of needle rotations (times) for ASU6. The y-axis ranges from 0 to 350, and the x-axis ranges from 0 to 12. Five curves represent pressures of 0.1MPa, 0.3MPa, 0.5MPa, 0.7MPa, and 0.9MPa. The flow rate increases with the number of rotations and plateaus at higher pressures.</p>	<p>Graph showing Flow rate (l/min.(ANR)) vs Pressure (MPa) for ASU6. The y-axis ranges from 0 to 300, and the x-axis ranges from 0 to 0.9. A single linear curve shows a direct proportionality between pressure and flow rate.</p>
ASU8	<p>Graph showing Flow rate (l/min.(ANR)) vs Number of needle rotations (times) for ASU8. The y-axis ranges from 0 to 700, and the x-axis ranges from 0 to 12. Five curves represent pressures of 0.1MPa, 0.3MPa, 0.5MPa, 0.7MPa, and 0.9MPa. The flow rate increases with the number of rotations and plateaus at higher pressures.</p>	<p>Graph showing Flow rate (l/min.(ANR)) vs Pressure (MPa) for ASU8. The y-axis ranges from 0 to 600, and the x-axis ranges from 0 to 0.9. A single linear curve shows a direct proportionality between pressure and flow rate.</p>

Tubing

Clean tubing

Processed tubing

PushOne fitting

QuickSeal fitting

Clean fitting/Chemifit

Bamboo-shoot fitting

Control switch/Detachable series

Jig/Tool/Accessory

Technical information

Reference

Effective sectional Area

1 Effective sectional area of fitting

Measurement method (JIS B 8381-1995 compliant)

Attach a switching valve to a container of inner volume [V], and attach a sample fitting (*) to the outlet of the switching valve. Fill 0.5MPa air in the container. Open the valve to release air for time until the air pressure inside the container decreases to 0.2MPa. Wait until the inside pressure is stabilized. Measure the residual pressure and calculate the effective sectional area using the following equation.

(*) Connect a tubing listed in Table 1 to the fitting and cut the tubing at the fitting end.

$$S = \left(12.9V \times \frac{1}{t} \log_{10} \frac{P_0 + 0.101}{P + 0.101} \right) \sqrt{\frac{273}{T + 273}}$$

- S : Effective sectional area (mm²)
- V : Inner volume of container (ℓ)
- P₀ : Initial pressure inside container (MPa)
- P : Residual pressure (MPa)
- t : Release time (s)
- T : Room temperature (°C)

[Table 1] Test tubing size list

Test fitting	Fitting size	Tubing size
	3	3x1.8
	4	4x2.5
PushOne A series	6	6x4
PushOne E series	8	8x6
QuickSeal series Insertless type	10	10x7.5
Chemifit C1 series	12	12x9
Chemifit C1S series	16	16x13
Chemifit CP series	1/4	6.35x4.57
	5/16	7.94x5.90
	3/8	9.53x6.99
	1/2	12.7x9.56

(*) For QuickSeal series (insertion type, DK tubing dedicated type, nylon coil tubing dedicated type), bamboo-shoot series (barb type), Chemifit CSE series, use applicable tubing size.

2 Effective sectional area of tubing

Relation of tubing length and effective sectional area (mm²) for various tubing inner diameters (mm)

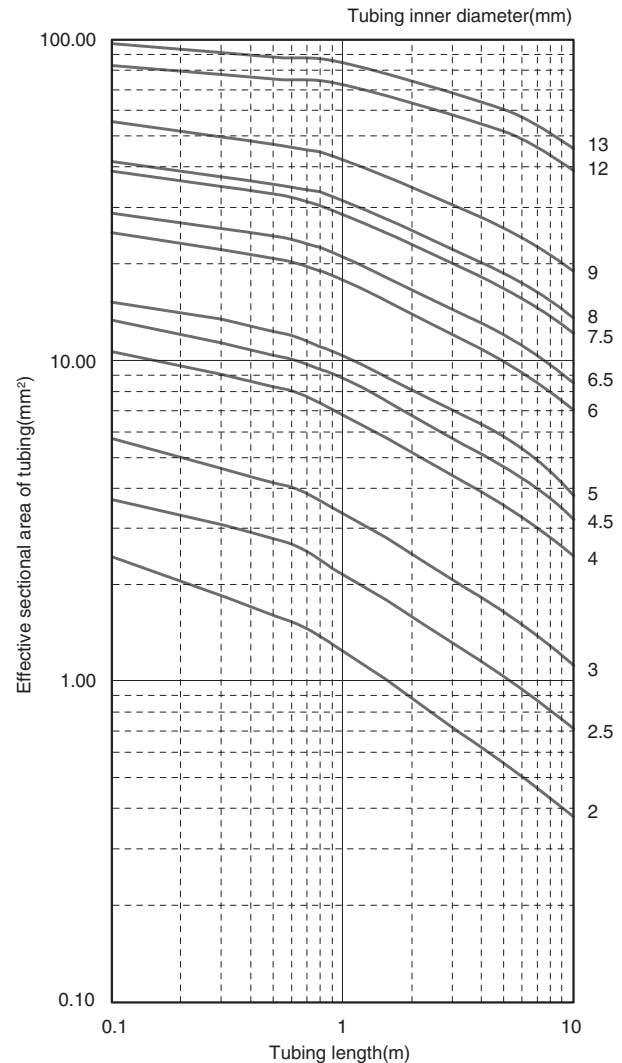

3 Calculation of combined effective sectional area

(1) Series connection

$$\frac{1}{S^2} = \sum_{i=1}^n \left(\frac{1}{S_i^2} \right) = \frac{1}{S_1^2} + \frac{1}{S_2^2} + \dots + \frac{1}{S_n^2}$$

- S : Combined effective sectional area (mm²)
- S_i : S₁ ... S_n: Effective sectional area of each element (mm²)

(2) Parallel connection

$$S = \sum_{i=1}^n (S_i) = S_1 + S_2 + \dots + S_n$$

- S : Combined effective sectional area (mm²)
- S_i : S₁ ... S_n: Effective sectional area of each element (mm²)

4 Air consumption

(1) Sound speed flow

$$\frac{P_1 + 0.1013}{P_2 + 0.1013} \geq 1.89$$

$$Q = 113 \times S \times (P_1 + 0.1013)$$

- Q : Air flow rate (ℓ/min. atmospheric pressure basis)
- P₁ : Primary pressure (MPa)
- P₂ : Secondary pressure (MPa)
- S : Effective sectional area of the narrow part (mm²)

(2) Subsonic flow

$$\frac{P_1 + 0.1013}{P_2 + 0.1013} \leq 1.89$$

$$Q = 226 \times S \times \sqrt{(P_2 + 0.1013) \times (P_1 - P_2)}$$

- Q : Air flow rate (ℓ/min. atmospheric pressure basis)
- P₁ : Primary pressure (MPa)
- P₂ : Secondary pressure (MPa)
- S : Effective sectional area of the narrow part (mm²)

Negative Pressure Performance List

Product name	Unit	Standard	Absolute vacuum ←				→ Atmospheric pressure	
			Gauge pressure [Gauge]	-101.325kPa G	-101.294kPa G	-99.975kPa G	-98.642kPa G	0kPa G
			Absolute pressure [abs]	0kPa abs	0.030kPa abs	1.350kPa abs	2.683kPa abs	101.325kPa abs
Tubing (*1) (U5,U2,U1,N5,N2,N1,TES,PL,PN,TA,TP,FS,FW,FWU,UE,DK,PB,UC,USC,UMC,UML,S)								
PushOne series	A series							
	E series							
QuickSeal series	Insertion type							
	Insertless type							
Bamboo-shoot fitting series	Barb type							
Chemifit series	C1 series							
	C1S series							
	CSE series							
	CP series							
Switch and detachable series (*2)	Q.D.C 101 series							
	Q.D.C 103 series							
	Miniature valve							

Shaded area : Usable

(*1) Influence of permeation, etc., on the operation fluid should be checked under your company's use conditions.

(*2) Other control and switch products (speed controller, ball valve, throttle valve, and valve built-in connector) cannot be used at a negative pressure.

About explanations of negative pressure performance

In pages introducing each product, the unit of negative pressure performance is based on atmospheric pressure, which is gauge pressure.

Therefore, negative pressure performance is indicated by adding a minus sign in front.

In addition, the character "G" is omitted on signage of the unit.

(Unit conversion)

$$-101.325\text{kPa G} = -760\text{mmHg G} = -760\text{Torr G}$$

Tubing

Clean tubing

Processed tubing

PushOne fitting

QuickSeal fitting

Clean fitting/
Chemifit

Bamboo-shoot fitting

Control switch/
Detachabile series

Jig/Tool/
Accessory

Technical information

Reference

Instruction Manual for PushOne™ A and E Series

1 Preparation before piping

Prepare a tube cutter and attachment tools of an appropriate size.



(Note)

- Select an appropriate tube cutter TC01, TC04 or HC03 for the tubing size. See [Table 1] for the applicable tubing size of each cutter.
- Seal-processed thread of the PushOne series does not require sealing tape.

- Caution:** Close the tube cutter blades when not using the cutter.
- Caution:** Check that the fitting and the tubing meet the specifications of the piping environment. Incorrect selection of products may cause an extremely serious accident.

[Table 1] Applicable tubing size of tube cutter

Tube cutter product number	Applicable tubing outer diameter(mm)
TC01	~13(1/2inch)
TC04	~16(5/8inch)
HC03	~20(3/4inch)

2 Attaching a fitting (re-attaching a fitting)

Use appropriate-size attachment tools to attach a fitting. Tighten the fitting to the recommended tightening torque given in [Table 2.]



(Note)

- Usually, processed seal can be used two or three times.
- When the processed seal becomes less effective, bind sealing tape around the seal-processed thread. The sealing tape should be bound 2-2.5 times in the correct direction, leaving one or two ridges unsealed from the end.



- Caution:** When a hexagon spanner is used for hexagon socket connector, be sure not to touch the lock ring part or the tubing seal part of the fitting to prevent disconnection of tubing and leakage.
- Caution:** Over-tightening of M thread could break the thread part or deform gasket, causing leakage. Be sure to tighten the thread to the recommended torque.
- Caution:** When reattaching a fitting, be careful not to let the sealing material of the seal-processed part contaminate operating fluid.

[Table 2] Recommended tightening torque for PushOne series

Thread size (JIS B 0205 : 2001) (JIS B 0203 : 1999)	Recommended tightening torque (N · m)
M3	0.7
M5	1.2
M6	2.0
R1/8	3.0-5.0
R1/4	7.0-9.0
R3/8	18.0-20.0
R1/2	20.0-22.0

3 Cut the tubing

Cutting tubes at a right angle with a tube cutter. Clean the surfaces of tubes before cutting. Select undented, undamaged, well-shaped tubes.



- Caution:** Do not leave dirt, dents, damage, deformations, burrs, or fluff on the cut surface. Do not cut tubes at a titled angle. The seal of the connection could be damaged, causing leakage.

4 Connect tubing and finishing work.



Insert the tubing steadily straight into the fitting until the tubing reaches the end. After inserting the tubing, try to pull it out gently and check that it will not pop out.



(Note)

- The insertion length of the tubing is summarized in [Table 3]. See the table for reference.
- Before inserting a tubing, mark the tubing at the insertion length from the end so that you can check if the tubing is properly inserted. See [Table 3] for the tubing insertion length. If the mark comes to the edge of the release sleeve and if the tubing would not be pulled out easily, the tubing connection work is completed.
- The millimeter and the inch size types of the PushOne E series are distinguished by a punch mark (of tubing size) on the release sleeve and the release sleeve color (millimeter: blue, inch: white). $\phi 8$ and $\phi 5/16$ types share a release sleeve mold with the same size mark, and therefore should be distinguished only by the release sleeve color.



-  Caution: An improperly inserted tubing may cause disconnection or leakage.
-  Caution: If you use other manufacturers' tubes to make the connection, check that the outer diameter tolerance of the tubing lies in the range of the size tolerance given in [Table 4]. If it does not, leakage may occur.

[Table 3] Insertion length of PushOne series tubing

PushOne series	Applicable tubing outer diameter(mm)	Insertion length of tubing (mm)
PushOne A series Mini type	3	9
	4	10
	6	11
PushOne A series PushOne E series	4	13
	6	15
	8	16
	10	19
	12	20
	16	27
	6.35(1/4inch)	15
	7.94(5/16inch)	16
	9.53(3/8inch)	19
	12.70(1/2inch)	21



[Table 4] Outer diameter tolerance of applicable tubing

Tubing material	Outer diameter tolerance of tubing (mm)
Polyurethane tubing	±0.1
Nylon tubing	±0.1

5 Disconnect tubing

Re-insert the tubing into the fitting body until the tubing reaches the end, and pull it out straight from the fitting while pushing the release sleeve evenly with two fingers. Do not twist the tubing when pulling it out.



-  Caution: If you try to pull out or twist a tubing without re-inserting it until it reaches the end and without sufficiently pressing the release sleeve, the tubing will not come out.
-  Caution: Be sure to make the internal pressure zero before disconnecting a tubing.

6 Re-connect tubing

Repeat the steps from “3. Cut the tubing”. If you re-connect a disconnected tubing, cut off the tip where a claw pattern is left. Also, confirm that there is no dirt, dents, damage, or deformations on the tubing.

-  Caution: In the event internal pressure or heat changes the inner and outer diameters of tubing, replace the tubing with a new one.

Instruction Manual for QuickSeal Series

1 Preparation before piping

Prepare a tube cutter, attachment tools of an appropriate size and sealing tape.



(Note)

- ☞ Select an appropriate tube cutter TC01, TC04 or HC03 for the tubing size. See [Table 1] for the applicable tubing size of each cutter.
- ☞ The seal-processed brass connector of the QuickSeal series does not require sealing tape.

- ⚠ Caution: Close the tube cutter blades when not using the cutter.
- ⚠ Caution: Check that the fitting and the tubing meet the specifications of the piping environment. Incorrect selection of products may cause an extremely serious accident.

[Table 1] Applicable tubing size of tubing cutter

Tube cutter product number	Applicable tubing outer diameter(mm)
TC01	~13(1/2inch)
TC04	~16(5/8inch)
HC03	~20(3/4inch)

2 Winding of sealant tape

The sealing tape should be bound 2-2.5 times in the correct direction, leaving one or two ridges unsealed from the end. Seal-processed brass connector of the QuickSeal series does not require sealing tape.



(Note)

- ☞ When the seal on brass connector becomes less effective, bind sealing tape around the seal-processed thread.
- ☞ Usually, a processed seal can be used two or three times.

- ⚠ Caution: When reattaching a seal-processed product, be careful not to let the sealing material contaminate the operating fluid.
- ⚠ Caution: When reattaching a fitting other than seal-processed products, remove the old seal on the thread and bind with new sealing tape. The old sealing tape could contaminate the operating fluid and cause problems.

3 Mounting

Use appropriate-size attachment tools to attach a fitting. Tighten the fitting to the recommended tightening torque given in [Table 2].

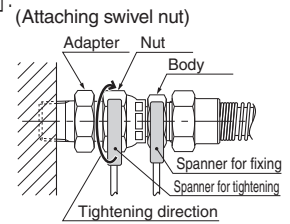

First, tighten by hand. Then tighten the nut with a torque wrench while fixing the nipple with a spanner.

- ⚠ Caution: The thread may become seized with high heat in the stainless type of fitting. Tighten slowly to prevent the thread from seizing.
- ⚠ Caution: Quick rotation of a torque wrench to tighten a swivel nut fitting generates small pressure on the sheet surface and could cause leakage.

[Table 2] Recommended tightening torque for QuickSeal series

Thread size (JIS B 0203 : 1999) (JIS B 0202 : 1999)	Recommended tightening torque (N · m)
R1/8	3.0-5.0
R1/4	7.0-9.0
R3/8	18.0-20.0
R1/2	20.0-22.0
G1/8	15
G1/4	25
G3/8	50
G1/2	60

4 Cut the tubing

Cutting tubes at a right angle with a tube cutter. Clean the surfaces of tubes before cutting. Select undented, undamaged, well-shaped tubes.



(Note)

- ☞ When you cut a DK tubing, be sure not to deform the tubing tip. An old blade cutter may cause deformation. Use a new tube cutter in this case.
- ☞ Use hose cutter HC01 for cutting S3/4-type nylon coil tubing.

- ⚠ Caution: Do not leave dirt, dents, damage, deformations, burrs, or fluff on the cut surface. Do not cut the tubes at a tilted angle. The seal of the connection, causing leakage.

5 Insert tubing into the nut and the sleeve

Insert tubing into the nut and the sleeve as shown in the photograph. The sleeve has a correct insertion direction. The thicker part should face the tubing end direction. Leave a space of more than 1cm long between the sleeve and the tubing end.



(Note)

☞ The millimeter and the inch size types of the QuickSeal series insertion type are distinguished by a punch mark (of tubing size) on the fitting body, the cut on the nut, and the sleeve color (millimeter: milky white, inch: black).

☞ Use a tubing insertion part (SI 3/4) for 3/4-size nylon coil tubing QuickSeal fitting.



6 Insert tubing

Insert the tubing into the fitting body until the tubing reaches the end.



(Note)

☞ The insertion length of the tubing is summarized in [Table 3]. See the table for reference.

⚠ Caution: If you use other manufacturers' tubes to make the connection, check that the outer diameter tolerance of the tubing lies in the range of the size tolerance given in [Table 4]. If it does not, leakage may occur. An improperly inserted tubing may cause disconnection or leakage.

[Table 3] Insertion length of QuickSeal series tubing

Type	Applicable tubing outer diameter (mm)	Insertion length of tubing (mm)	Type	Applicable tubing outer diameter (mm)	Insertion length of tubing (mm)		
Insertion type (group 4) DK tubing dedicated type	4	15	Insertion type (group 2)	3.18(1/8inch)	21		
	6	15					
	8	16	Insertless type	4	14		
	10	17		6	14		
12	18	8		15			
16	23	10		18			
Insertion type (group 1) Insertion type (group 2)	3.18(1/8inch)	15	Type	Applicable tubing product number	Insertion length of tubing (mm)		
	4.76(3/16inch)	15				S3/16	16
	6.35(1/4inch)	15				S1/4	18
	7.94(5/16inch)	16				S3/8	22
	9.53(3/8inch)	17				S1/2	29
12.70(1/2inch)	18	S3/4	31				
	15.88(5/8inch)	23					

[Table 4] Outer diameter tolerance of applicable tubing

Tubing material	Outer diameter tolerance of tubing (mm)
Polyurethane tubing	±0.1
Nylon tubing	±0.1

7 Tightening nuts by hand

Tighten the nut by hand.

(Note)

☞ It is recommended to mark the nut and the fitting body at the hand tightened position in order to check the number of rotations of the nut.



8 Tightening nuts and finishing work

Tighten the hand tightened nut with a spanner or a crescent wrench according to the appropriate number of rotations for tightening the nuts given in [Table 5].



(Note)

☞ Before inserting a tubing, mark the tubing at the insertion length from the end so that you can check if the tubing is properly inserted. If the marking moves 1-2mm from the sleeve end by tightening the nut, it is a sign that the nut is properly tightened.



- ⚠ Caution: The thread may become seized with high heat in the stainless type of fitting. Tighten slowly to prevent seizing of thread.
- ⚠ Caution: The appropriate number of rotations for tightening nuts varies depending on the size and material of sleeve. Be sure to check the appropriate number of rotations.
- ⚠ Caution: For use of the QuickSeal series at a high temperature within the working temperature range, tighten the nut periodically. If the nut cannot be tightened further, cut off the tubing end as well as the sleeve and repeat the steps from "4. Cut the tubing" with a new sleeve.

[Table 5] Appropriate number of rotations for tightening nuts

Sleeve material	Applicable tubing outer diameter (mm)	Appropriate number of rotations for tightening nuts	Sleeve material	Applicable tubing outer diameter (mm)	Appropriate number of rotations for tightening nuts
Nylon sleeve	4	2~2.5	Brass sleeve	4	1~1.5
	6	2~2.5		6	1~1.5
	8	2~2.5		8	1~1.5
	10	2~2.5		10	1.5~2
	12	2~2.5		12	1.5~2
	16	2~2.5		3.18(1/8inch)	1~1.5
Nylon sleeve	3.18(1/8inch)	2~3	4.76(3/16inch)	1~1.5	
	4.76(3/16inch)	2~3	6.35(1/4inch)	1~1.5	
	6.35(1/4inch)	2~3	7.94(5/16inch)	0.75~1.25	
	7.94(5/16inch)	2~3	9.53(3/8inch)	0.75~1.25	
	9.53(3/8inch)	2~3	12.70(1/2inch)	0.75~1.25	
	12.70(1/2inch)	2~3			
	15.88(5/8inch)	2.5~3			
			Type	Applicable tubing product number	Appropriate number of rotations for tightening nuts
			Nylon coil tubing dedicated type	S3/16	1.5~2
				S1/4	2~2.5
				S3/8	2~2.5
				S1/2	2.5~3
			S3/4	2~2.5	

9 Re-connect tubing

Cut off the tubing end as well as the sleeve and repeat the steps from "4. Cut the tubing" with a new sleeve. Confirm that there is no dirt, dents, damage, and or deformations on the tubing surface.

(Note)

☞ If you reuse a nut, check that the nut is not damaged. A damaged nut could cause problems such as improper tightening or leakage.

- ⚠ Caution: In the event internal pressure or heat changes the inner and outer diameters of tubing, replace the tubing with a new one.

Instruction Manual for Chemifit™ C1 Series

Tubing

1 Preparation before piping

Prepare a tube cutter and crescent wrench, and sealing tape.



(Note)

☞ Select an appropriate tube cutter TC01, TC04 or HC03 for the tubing size. See [Table 1] for the applicable tubing size of each cutter.

- ⚠ Caution: Close the tube cutter blades when not using the cutter.
- ⚠ Caution: Check that the fitting and the tubing meet the specifications of the piping environment. Incorrect selection of products may cause an extremely serious accident.

[Table 1] Applicable tubing size of tube cutter

Tube cutter product number	Applicable tubing outer diameter(mm)
TC01	~13(1/2inch)
TC04	~16(5/8inch)
HC03	~20(3/4inch)

2 Winding of sealant tape

The sealing tape should be bound 2-2.5 times in the correct direction, leaving one or two ridges unsealed from the end.



3 Mounted fittings

First, tighten a fitting by hand. Then tighten it about two turns with a crescent wrench.



- ⚠ Caution: Over-tightening could damage the resin thread and cause deformation and leakage.
- ⚠ Caution: Use a crescent wrench to tighten the hexagonal (HEX) part, which is made of resin. Using a spanner could cause damage to the HEX part.

4 Cut the tubing

Cutting tubes at a right angle with a tube cutter. Clean the surfaces of tubes before cutting. Select undented, undamaged, well-shaped tubes.



- ⚠ Caution: Do not leave dirt, dents, damage, deformations, burrs, or fluff on the cut surface. Do not cut tubes at a titled angle. The seal of the connection could be damaged, causing leakage.

5 Connect tubing and finish work.

Insert the tubing steadily straight into the fitting until the tubing reaches the end. After inserting the tubing, try to pull it out gently and check that it will not pop out.



(Note)

- ☞ The millimeter and the inch size types of the Chemifit C1 series are distinguished by a punch mark of tubing size on the release sleeve.
- ☞ The insertion length of the tubing is summarized in [Table 2]. See the table for reference.

- ⚠ Caution: An improperly inserted tubing may cause disconnection or leakage.
- ⚠ Caution: Chemifit C1 series has a resin thread, which allows stress relaxation relatively easily compared to metal thread. In some cases oozing leakage occurs. In particular at a high temperature, tighten the fitting periodically. If the fitting cannot be tightened further, replace it with a new one.
- ⚠ Caution: If you use other manufacturers' tubes to make the connection, use a tubing with a size tolerance within ± 0.1 mm. Otherwise, leakage may occur.

[Table 2] Insertion length of Chemifit C1 series tubing

Series name	Applicable tubing outer diameter(mm)	Insertion length of tubing (mm)
Chemifit C1 series	3	11
	4	14
	6	15
	8	16
	10	19
	12	20
	3.18(1/8inch)	11
	6.35(1/4inch)	16
	9.53(3/8inch)	20
	12.70(1/2inch)	23

Clean tubing

Processed tubing

PushOne fitting

QuickSeal fitting

Clean fitting/Chemifit

Bamboo-shoot fitting

Control switch/Detachable series

Jig/Tool/Accessory

Technical information

Reference

6 Disconnect tubing

Re-insert the tubing into the fitting body until the tubing reaches the end, and pull it out straight from the fitting while pushing the release sleeve evenly with two fingers. Do not twist the tubing when pulling it out.



- ⚠ Caution:** If you try to pull out or twist a tubing without re-inserting it until it reaches the end and without sufficiently pressing the release sleeve, the tubing will not come out.
- ⚠ Caution:** Be sure to make the internal pressure zero before disconnecting a tubing.

7 Re-connect tubing

Repeat the steps from “4. Cut the tubing”. If you re-connect a disconnected tubing, cut off the tip where a claw pattern is left. Also, confirm that there is no dirt, dents, damage, or deformations on the tubing.

- ⚠ Caution:** In the event internal pressure or heat changes the inner and outer diameters of tubing, replace the tubing with a new one.

Tubing

Clean tubing

Processed tubing

PushOne fitting

QuickSeal fitting

Clean fitting/
Chemifit

Bambooshoot fitting

Control switch/
Detachable series

Jig/Tool/
Accessory

Technical information

Reference

Instruction Manual for Chemifit™ C1S Series

Tubing

Clean tubing

Processed tubing

PushOne fitting

QuickSeal fitting

Clean fitting/Chemifit

Bamboo-shoot fitting

Control switch/Detachable series

Jig/Tool/Accessory

Technical information

Reference

1 Preparation before piping

Prepare a tube cutter, attachment tools of an appropriate size and sealing tape.



(Note)

Select an appropriate tube cutter TC01, TC04 or HC03 for the tubing size. See [Table 1] for the applicable tubing size of each cutter.

- ⚠ Caution: Close the tube cutter blades when not using the cutter.
- ⚠ Caution: Check that the fitting and the tubing meet the specifications of the piping environment. Incorrect selection of products may cause an extremely serious accident.

[Table 1] Applicable tubing size of tube cutter

Tube cutter product number	Applicable tubing outer diameter(mm)
TC01	~13(1/2inch)
TC04	~16(5/8inch)
HC03	~20(3/4inch)

2 Winding of sealant tape

The sealing tape should be bound 2-2.5 times in the correct direction, leaving one or two ridges unsealed from the end.



- ⚠ Caution: When reattaching the fitting body, remove the old seal on the thread and bind with new sealing tape. The old sealing tape could contaminate the operating fluid and cause problems.

3 Mounting

Use appropriate-size attachment tools to attach a fitting. Tighten the fitting to the recommended tightening torque given in [Table 2].



- ⚠ Caution: Tighten slowly to prevent the thread from seizing.
- ⚠ Caution: Over-tightening of M thread could break the thread or deform the gasket, causing leakage. Be sure to tighten it to the recommended torque.

[Table 2] Recommended tightening torque for Chemifit C1S series

Thread size (JIS B 0205 : 2001) (JIS B 0203 : 1999)	Recommended tightening torque (N · m)
M5	1.2
R1/8	3.0-5.0
R1/4	7.0-9.0
R3/8	18.0-20.0
R1/2	20.0-22.0

4 Cut the tubing

Cutting tubes at a right angle with a tube cutter. Clean the surfaces of tubes before cutting. Select undented, undamaged, well-shaped tubes.



- ⚠ Caution: Do not leave dirt, dents, damage, deformations, burrs, or fluff on the cut surface. Do not cut tubes at a tilted angle. The seal of the connection could be damaged, causing leakage.

5 Connect tubing and finishing work

Insert the tubing steadily straight into the fitting until the tubing reaches the end. After inserting the tubing, try to pull it out gently and check that it will not pop out.

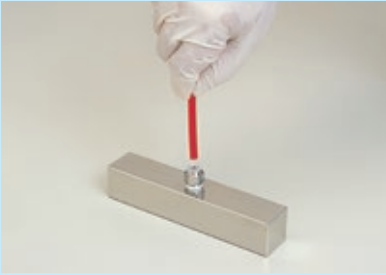

(Note)

 The millimeter and the inch size types of the Chemifit C1S series are distinguished by a punch mark of tubing size on the release sleeve. The insertion length of the tubing is summarized in [Table 3]. See the table for reference.

 Caution: An improperly inserted tubing may cause disconnection or leakage.

 Caution: If you use other manufacturers' tubes to make the connection, use a tubing with a size tolerance within $\pm 0.1\text{mm}$. Otherwise, leakage may occur.

[Table 3] Insertion length of Chemifit C1S series tubing

Series name	Applicable tubing outer diameter(mm)	Insertion length of tubing (mm)
Chemifit C1S series	3	11
	4	14
	6	15
	8	16
	10	19
	12	20
	3.18(1/8inch)	11
	6.35(1/4inch)	16
	9.53(3/8inch)	20
12.70(1/2inch)	23	

6 Disconnect tubing

Re-insert the tubing into the fitting body until the tubing reaches the end, and pull it out straight from the fitting while pushing the release sleeve evenly with two fingers. Do not twist the tubing when pulling it out.



 Caution: If you try to pull out or twist a tubing without re-inserting it until it reaches the end and without sufficiently pressing the release sleeve, the tubing will not come out.

 Caution: Be sure to make the internal pressure zero before disconnecting a tubing.

7 Re-connect tubing

Repeat the steps from "Cut the tubing". If you re-connect a disconnected tubing, cut off the tip where a claw pattern is left. Also, confirm that there is no dirt, dents, damage, or deformations on the tubing.

 Caution: In the event internal pressure or heat changes the inner and outer diameters of tubing, replace the tubing with a new one.

Instruction Manual for Chemifit™ CSE Series

Tubing

Clean tubing

Processed tubing

PushOne fitting

QuickSeal fitting

Clean fitting/ Chemifit

Bamboo-shoot fitting

Control switch/ Detachable series

Jig/Tool/ Accessory

Technical information

Reference

1 Preparation before piping

Prepare a tube cutter, attachment tools of an appropriate size and sealing tape.



(Note)

Select an appropriate tube cutter TC01, TC04 or HC03 for the tubing size. See [Table 1] for the applicable tubing size of each cutter.

- ⚠ Caution: Close the tube cutter blades when not using the cutter.
- ⚠ Caution: Check that the fitting and the tubing meet the specifications of the piping environment. Incorrect selection of products may cause an extremely serious accident.

[Table 1] Applicable tubing size of tube cutter

Tube cutter product number	Applicable tubing outer diameter(mm)
TC01	~13(1/2inch)
TC04	~16(5/8inch)
HC03	~20(3/4inch)

2 Winding of sealant tape

The sealing tape should be bound 2-2.5 times in the correct direction, leaving one or two ridges unsealed from the end.



- ⚠ Caution: When reattaching the fitting body, remove the old seal on the thread and bind with new sealing tape. The old sealing tape could contaminate the operating fluid and cause problems.

3 Mounting

Use appropriate-size attachment tools to attach a fitting. Tighten the fitting to the recommended tightening torque given in [Table 2].



- ⚠ Caution: Tighten slowly to prevent the thread from seizing.

[Table 2] Recommended tightening torque for Chemifit CSE series

Thread size (JIS B 0203 : 1999)	Recommended tightening torque (N · m)
R1/8	3.0-5.0
R1/4	7.0-9.0
R3/8	18.0-20.0
R1/2	20.0-22.0

4 Cut the tubing

Cutting tubes at a right angle with a tube cutter. Clean the surfaces of tubes before cutting. Select undented, undamaged, well-shaped tubes.



- ⚠ Caution: Do not leave dirt, dents, damage, deformations, burrs, or fluff on the cut surface. Do not cut tubes at a tilted angle. The seal of the connection could be damaged, causing leakage.

5 Insert tubing into the assembly nut

Insert tubing into the assembly nut in such a direction that the thread part faces the tubing end.



6 Insert tubing

Insert the tubing into the fitting body until the tubing reaches the end.



(Note)

- ☞ The insertion length of the tubing is summarized in [Table 3]. See the table for reference.
- ☞ The millimeter and the inch size types of the Chemifit CSE series are distinguished by a boss at the internal sleeve as shown on the right.

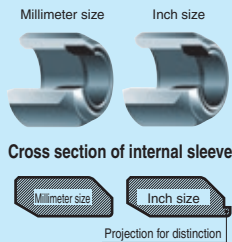

⚠ Caution: If you use other manufacturers' tubes to make the connection, use a tubing with a size tolerance within ± 0.1 mm. Otherwise, leakage may occur.

⚠ Caution: An improperly inserted tubing may cause disconnection or leakage.

[Table 3] Insertion length of Chemifit CSE series tubing

Applicable tubing outer × inner diameters (mm)	Insertion length of tubing (mm)
4×2	5.5
6×4	7.0
8×5	7.5
8×6	7.5
10×6.5	8.5
10×8	8.5
12×9	10.0
12×10	10.0
19×16	12.5
6.35×4.57(1/4inch)*	7.0
9.53×6.99(3/8inch)*	8.5
12.70×9.56(1/2inch)*	10.5

*Tube outer diameter

7 Tightening nuts by hand

Tighten the assembly nut by hand.



8 Tightening nuts

Tighten the hand-tightened nut with a spanner or a crescent wrench until the nut reaches the fitting body.



9 Tightening completed

If the assembly nut touches the fitting body, the assembly work is completed.



10 Re-connect tubing

Cut off the tubing end and repeat the steps from "4. Cut the tubing". Confirm that there is no dirt, dents, damage, or deformations on the tubing surface.

(Note)

- ☞ If you reuse an assembly nut, check that the internal sleeve is not damaged. A damaged assembly nut could cause problems such as leakage.

⚠ Caution: Be sure to make the internal pressure zero before disconnecting a tubing.

⚠ Caution: In the event internal pressure or heat changes the inner and outer diameters of tubing, replace the tubing with a new one.

Instruction Manual for Chemifit™ CP Series

Tubing

Clean tubing

Processed tubing

PushOne fitting

QuickSeal fitting

Clean fitting/ Chemifit

Bambooshoot fitting

Control switch/ Detachable series

Jig/Tool/ Accessory

Technical information

Reference

1 Preparation before piping

Prepare a tube cutter, a crescent wrench and sealing tape.



(Note)

Select an appropriate tube cutter TC01, TC04 or HC03 for the tubing size. See [Table 1] for the applicable tubing size of each cutter.

- ⚠ Caution: Close the tube cutter blades when not using the cutter.
- ⚠ Caution: Check that the fitting and the tubing meet the specifications of the piping environment. Incorrect selection of products may cause an extremely serious accident.

[Table 1] Applicable tubing size of tube cutter

Tube cutter product number	Applicable tubing outer diameter(mm)
TC01	~13(1/2inch)
TC04	~16(5/8inch)
HC03	~20(3/4inch)

2 Winding of sealant tape

The sealing tape should be bound 2-2.5 times in the correct direction, leaving one or two ridges unsealed from the end.



3 Mounting

First, tighten a fitting by hand. Then tighten it about two turns with a crescent wrench.



- ⚠ Caution: Over-tightening could damage the resin fittings body and cause deformation and leakage.
- ⚠ Caution: Use a crescent wrench to tighten the hexagonal (HEX) part, which is made of resin. Using a spanner could cause damage to the HEX part.

4 Cut the tubing

Cutting tubes at a right angle with a tube cutter. Clean the surfaces of tubes before cutting. Select undented, undamaged, well-shaped tubes.



- ⚠ Caution: Do not leave dirt, dents, damage, deformations, burrs, or fluff on the cut surface. Do not cut tubes at a tilted angle. The seal of the connection could be damaged, causing leakage.

5 Insert tubing into nut and sleeve (using insertion part)

Insert tubing first into nut, then into sleeve. Leave a space of more than 1cm long between the tubing end and the sleeve. (It is recommended to use an insertion part for flexible tubes such as polyolefin tubing.)

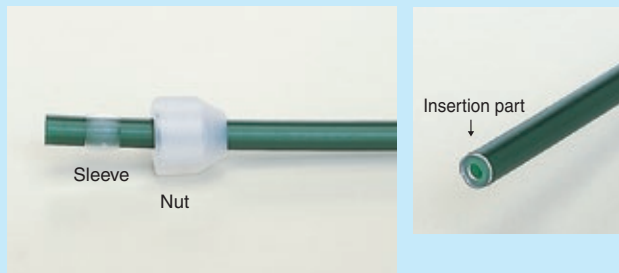

Insert tubing

Insert the tubing into the fitting body until the tubing reaches the end.



(Note)

The millimeter and the inch size types of the Chemifit CP series are distinguished by the shape of the sleeve. The insertion length of the tubing is summarized in [Table 2]. See the table for reference.

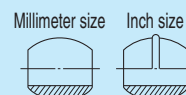

- ⚠ Caution: If you use other manufacturers' tubes to make the connection, use a tubing with a size tolerance within ± 0.1 mm. Otherwise, leakage may occur.
- ⚠ Caution: An improperly inserted tubing may cause disconnection or leakage.

[Table 2] Insertion length of Chemifit CP series tubing

Applicable tubing outer diameter(mm)	Insertion length of tubing (mm)
4	16
6	18
8	20
10	25
12	29
6.35(1/4 inch)	18
9.53(3/8 inch)	25
12.70(1/2 inch)	29

7 Tightening nuts by hand

Tighten the nut by hand with the tubing being inserted to the fitting body.



8 Tightening nuts

Tighten the hand-tightened nut 1.5-2 turns with a crescent wrench.



Caution: Use a crescent wrench to tighten the hexagonal (HEX) part, which is made of resin. Using a spanner could cause damage to the HEX part.

9 Tightening completed

If there is an appropriate space left between the nut and the fitting body as described in [Table 3], the assembly work is completed.



[Table 3] Space between the nut and the fitting body of the Chemifit CP series

Applicable tubing outer diameter(mm)	Space between the nut and the fitting body(mm)	Remaining number of ridges
4	0.5	1
6	1.0	1
8	2.5	1.5
10	3.5	2
12	3.5	2
6.35(1/4 inch)	1.0	1
9.53(3/8 inch)	1.0	1
12.70(1/2 inch)	2.5	1.5

Caution: The Chemifit CP series has a resin thread, which allows stress relaxation relatively easily compared to metal thread. In some cases leakage occurs. In particular at a high temperature, tighten the fitting periodically. If the fitting cannot be tightened further, replace it with a new one.

10 Re-connect tubing

Cut off the tubing end and repeat the steps from “4. Cut the tubing” with a new sleeve (and insertion part). Confirm that there is no dirt, dents, damage, or deformations on the tubing surface.

Caution: Be sure to make the internal pressure zero before disconnecting a tubing.

Caution: The Chemifit CP series is made of resin, hence the nut and body could be deformed. Confirm that the nut and body are not damaged. A damaged nut and body would cause leakage.

Caution: In the event internal pressure or heat changes the inner and outer diameters of tubing, replace the tubing with a new one.

101 series

(Note)

☞ See instruction manuals of appropriate specifications such as those of the PushOne series or QuickSeal series for handling thread and tubing connection parts.

- ⚠ Caution: Rotational use of a coupler and a nipple is not recommended.
- ⚠ Caution: Use the product at a pressure lower than the maximum working pressure.
- ⚠ Caution: Do not use the product under too much bending stress or tension.

1 Connection of coupler and nipple

Make the residual pressure on the coupler side zero. Check that there is no foreign matter in the connection part. Then insert the nipple to the coupler without pulling the sleeve on the coupler.

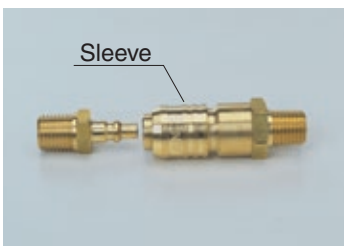

- ⚠ Warning: Do not hit the valve head with a hammer, etc., to release residual pressure. It could break the valve and be extremely dangerous.
- ⚠ Caution: Connection without releasing residual pressure may break the valve.
- ⚠ Caution: Insert the nipple straight into the coupler.
- ⚠ Caution: When connecting a coupler and a nipple, do not hold the sleeve of the coupler.

2 Disconnection of coupler and sleeve

Make the residual pressure on the coupler side zero. Pull out the coupler or the nipple to disconnect while pulling the sleeve of the coupler.

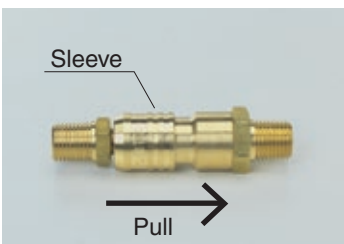

- ⚠ Warning: Be aware that disconnection without releasing residual pressure not only causes damage to the product body but will also cause an accident.

103 series

(Note)

☞ See instruction manuals of appropriate specifications such as those of the PushOne series or QuickSeal series for handling thread and tubing connection parts.

- ⚠ Caution: Rotational use of a coupler and a nipple is not recommended.
- ⚠ Caution: Use the product at a pressure lower than the maximum working pressure.
- ⚠ Caution: Do not use the product under too much bending stress or tension.

1 Connection of coupler and nipple

Make the residual pressure on the coupler side zero. Check that there is no foreign matter in the connection part. Then insert the nipple to the coupler without pulling the sleeve on the coupler.

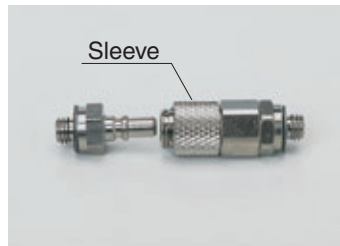

- ⚠ Warning: Do not hit the valve head with a hammer, etc., to release residual pressure. It could break the valve and be extremely dangerous.
- ⚠ Caution: Connection without releasing residual pressure may break the valve.
- ⚠ Caution: Insert the nipple straight into the coupler.
- ⚠ Caution: When connecting a coupler and a nipple, do not hold the sleeve of the coupler.

2 Disconnection of coupler and sleeve

Make the residual pressure on the coupler side zero. Pull out the coupler or the nipple to disconnect while pulling the sleeve of the coupler.

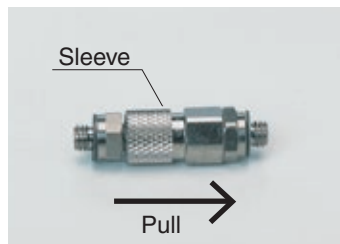

- ⚠ Warning: Be aware that fact that disconnection without releasing residual pressure not only causes damage to the product body but will also cause an accident.

1 Preparation and cut the tubing

Prepare a tube cutter and an outer cover peeling cutter of appropriate type described in [Table 1]. Cut the tubes at a right angle with a tube cutter. Clean the surfaces of tubes before cutting. Select undented, undamaged, well-shaped tubes.

(Note)

Select an appropriate tube cutter TC01 or TC04 for the tubing size. See [Table 2] for the applicable tubing size of each cutter.

[Table 1] Product number of applicable outer cover peeling cutter

Tubing type	Applicable tubing outer diameter(mm)	Product number of applicable outer cover peeling cutter
FW	6	TC02
	8	
	10	
	12	
FWU	6	TC02U
	8	
	10	
	12	

[Table 2] Tubing size applicable for tube cutter

Tube cutter product number	Applicable tubing outer diameter(mm)
TC01	~13(1/2inch)
TC04	~16(5/8inch)

2 Insert tubing

Contact the cutting surface of tubing with the blade in the insertion slot of the cutter.



Warning: Do not insert your finger into the insertion slot of the outer cover peeling cutter.

Caution: Do not use the cutter for tubes that Nitta does not designate.

3 Peeling outer cover and pulling out of tubing

Slowly insert the tubing while rotating to the contact surface in the cutter. When the tubing reaches the contact surface, pull it out slowly while rotating in the opposite direction.

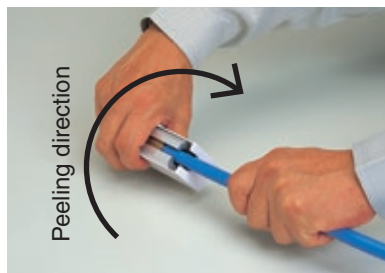

Warning: Do not pull out a tubing with a strong force or rotate it rapidly. Doing so may cause damage to the cutter blade or the outer surface of the tubing.

4 Removing outer cover

Remove the outer cover along the spiral cut line.



5 Completing work

The peeling work is completed if the peeled cover length satisfies the requirement shown in [Table 3].

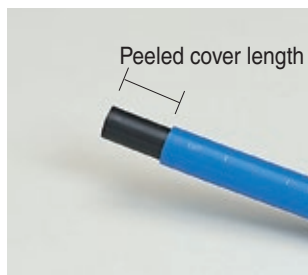

[Table 3] Peeled outer cover length

FW/FWU tubing outer diameter (mm)	Peeled outer cover length (mm)
6	15
8	16
10	19
12	20

Instruction Manual for Tube Reel

1 Check of the type and sizes

Check the product number and applicable tubing sizes and confirm that you have all the necessary parts.

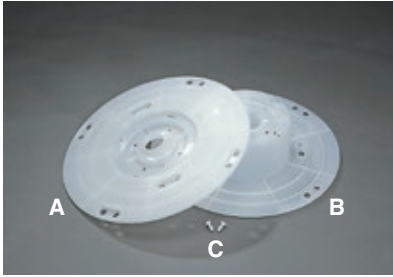

Specification of each part

Part	Name	Material	Color	Quantity
A	Reel plate	Polypropylene (P.P.)	White	1
B	Reel body	Polypropylene (P.P.)	White	1
C*	Reel fixing pin	Polycarbonate + Nylon	White	2

*Product number of reel fixing pin is PTR-P.

Combination

Product number	Combination
PTR-1	A+B+C
PTR-2	B+B+C

2 How to set PTR-1

For setting PTR-2, substitute "reel plate (A)" with "reel body (B)" in the following instructions and follow the same procedure.

2-1 Set the tubing

Place the reel body (B) as shown in the photograph, and a bundled tubing onto it. The tubing is bundled with tape. Place the tubing in such a direction so that the inside tubing end faces the clockwise direction.

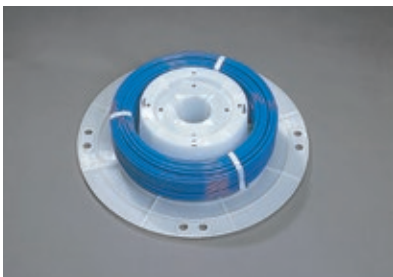

(Note)

It is recommended to cut the bundle tape somewhere inside and tape it temporarily onto the side of the bundle before you put the tubing bundle onto the reel body.

2-2 Position adjustment of inside tubing end

Pull out the inside tubing end from the bundle tape and rotate the tubing bundle for the tubing end to reach a hook of the reel body (B).



2-3 Fixing inside tubing end and setting reel plate

Cover the reel body with a reel plate (A) while inserting the position-adjusted tubing end into an inner-side hole (nearer one of two holes) of the reel plate.



2-4 Fixing reel plate

Adjust the position of the reel plate (A) to match the positions of a notch of the reel plate (A) and the hook of the reel body (B). Rotate the reel plate (A) counterclockwise to interlock the notch and the hook. (Tip: Rotate the reel plate (A) pressing its center slightly.) Fit the positions of the fixing pin holes of the reel body (B) and the reel plate (A).

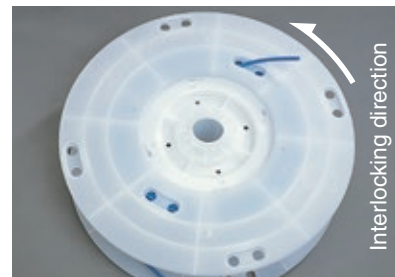
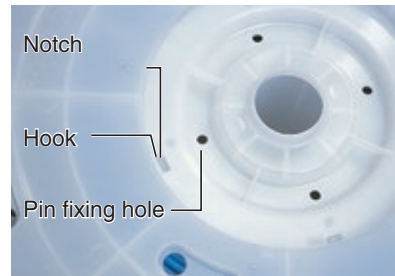

2-5 Insert fixing pins

Insert a reel fixing pin (C) into each of two fixing pin holes of the reel plate (A) to fix the plate with the reel body (B).

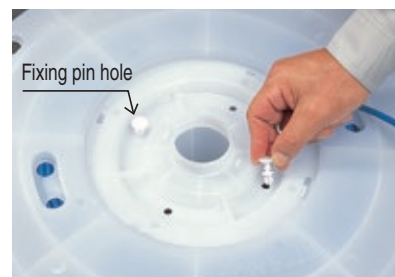

Tubing

Clean tubing

Processed tubing

PushOne fitting

QuickSeal fitting

Clean fitting/Chemifit

Bamboo-shoot fitting

Control switch/Detachable series

Jig/Tool/Accessory

Technical information

Reference

2-6 Setting inside tubing end

The inside tubing end coming out of the reel plate (A) should be re-inserted in the other hole of the reel plate (A) as in the photograph. Or rotate the tubing bundle by hand to an appropriate position.



2-7 Completing work

Insert the outside tubing end into the outer-side hole of the reel plate (A) and remove the bundle tape. The assembly of the tube reel is completed.

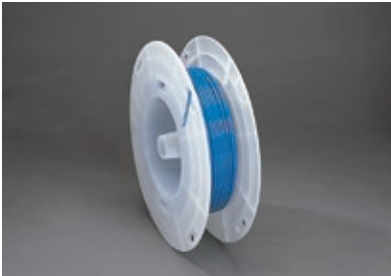

Instruction Manual for Spatter Cap

Tubing

Clean tubing

Processed tubing

PushOne fitting

QuickSeal fitting

Clean fitting/
Chemifit

Bamboo-shoot fitting

Control switch/
Detachable series

Jig/Tool/
Accessory

Technical information

Reference

CP/CPF

1 Attachment of CP (CPF)

Insert Tubing into CP (CPF) in such a direction that the larger diameter side faces the tubing end.



⚠ Caution: CP (CPF) can be used only for PushOne series (except mini type).

2 Insert into tube fitting

Insert the tubing into a fitting following the instruction manual of the PushOne series.



3 Setting CP (CPF)

Push CP (CPF) to cover the fitting body.



4 Completing work

Check if CP (CPF) is properly attached.



CPP

1 Insert into tube fitting

Insert the tubing into a fitting following the instruction manual of the PushOne series, and check if the tubing is properly inserted.



2 Attaching CPP

Open CPP halved in advance and cover the tubing connection part with them.



(Note)

👉 If you use CPP for FS tubing, there will be a 1mm space between the outer surface of the FS tubing and the inner surface of CPP.

⚠ Caution: CPP can be used only for PushOne series (except mini type).

3 Fixing CPP

Fix the hook of the CPP and close the opened body.



4 Completing work

Check if CPP is properly attached.



Instruction Manual for Off Tool

Put the guide of an off tool onto the outer surface of a tubing. Insert the tubing into the fitting body until it reaches the end. Pull the tubing straight out from the fitting while pressing the release sleeve with the off tool.



⚠ Caution: If you do not insert the tubing sufficiently and do not press the release sleeve completely, pulling out or twisting the tubing may cause permanent damage to the tubing.

⚠ Caution: Before you pull out tubing, make the inside pressure zero.

Tubing

Clean tubing

Processed tubing

PushOne fitting

QuickSeal fitting

Clean fitting/
Chemifit

Bambooshoot fitting

Control switch/
Detachable series

Jig/Tool/
Accessory

Technical information

Reference

Reference Information

INDEX

TES Tubing Technical Data

P.189

Applied Standard List

P.190

Screw Standard List

P.191

UL-94 Standard Flame Test

P.195

Table of Full Scale of Tubing and Screw

P.196

Unit Conversion Table

P.197

Chemical Resistance Specification Table

P.198

Tubing

Clean tubing

Processed tubing

PushOne fitting

QuickSeal fitting

Clean fitting/
Chemifit

Bamboo-shoot fitting

Control switch/
Detachable series

Jig/Tool/
Accessory

Technical information

Reference

TES Tubing Technical Data

● Comparison of flexibility



Test method

A test tubing is placed on a bending strength measurement machine and bent until a kink is created, at which moment the stress is measured.

Test condition

Test temperature:
Room temperature
Tubing size: 8 x 6

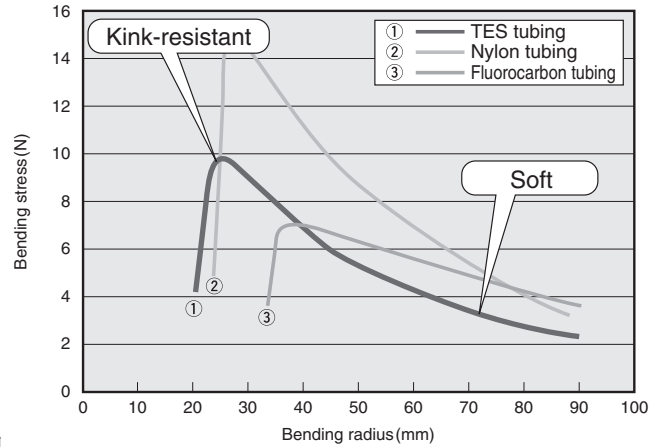
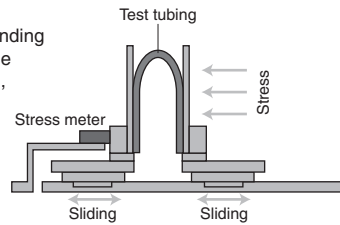

● Abrasion resistance

Test method

A tubing suspended from above and a counter tubing fixed on a rotating jig are rubbed together.

Test condition

Number of counter tubes: 11
Rotation speed: 60rpm
Number of rotations: 50,000
Weight mass: 500g
Test temperature: Room temperature

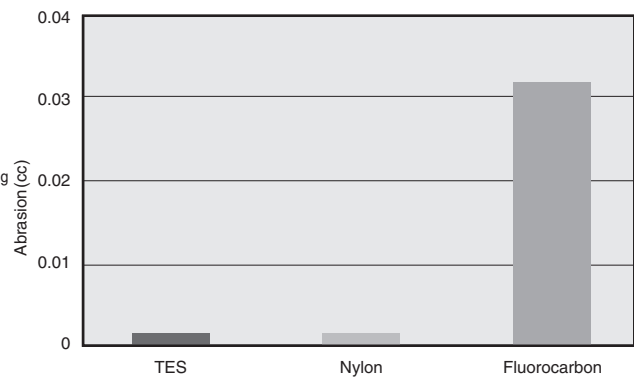
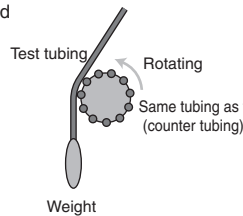

■ Chemical resistance performance table

Check chemical resistance of each material in Chemical resistance performance table for safe use of Nitta's products.

Criteria ○ = No influence × = Unusable
△ = Sufficient confirmation required

*When contacting us for the criteria △, please check ① working pressure, ② maximum working temperature, ③ concentration, ④ piping status, and ⑤ application.

- The criteria of the chemical resistance performance table are made under certain conditions. Therefore the criteria ○ can not ensure safety under different conditions, different environment, and different use period.
- Before using our products, check them under the actual use conditions in your company.
- Unless indicated specifically, test chemicals in the table are used at a saturated concentration and the test temperature is room temperature.
- The table presents the chemical resistance performance of materials, not the permeability of gas chemicals. Do not use chemicals (activated gases) that are hazardous if they permeate a tubing.
- When using a QuickSeal series fitting at a high temperature within the working temperature range, tighten the nut periodically. If the nut cannot be tightened further, cut off the tubing end and old sleeve and attach the tubing again with a new sleeve.

Category	Chemicals	Inner surface (fluorocarbon resin)	Outer surface (nylon)	Category	Chemicals	Inner surface (fluorocarbon resin)	Outer surface (nylon)	Category	Chemicals	Inner surface (fluorocarbon resin)	Outer surface (nylon)
Inorganic acid	Hydrochloric acid (35%)	○	×	Organic acid	Acetic acid	△	×	Amine	Aniline	△	×
	Sulfuric acid (98%)	△	×		Oxalic acid	○	○		Pyridine	○	×
	Nitric acid (25%)	○	×		Citric acid	○	○		Ethylenediamine	△	△
	Phosphoric acid (50%)	○	×		Stearic acid	○	○		Dimethylformamide	△	×
Alkali	Caustic soda (10%)	○	△		Formic acid	○	×	Aromatic series	Phenol	○	△
	Caustic potash (10%)	○	△		Trichloroacetic acid	○	×		Benzaldehyde	△	△
	Ammonium hydroxide (15%)	○	△		Lactic acid	○	△		Nitrobenzene	△	△
Other inorganic substance	Chlorine	△	×		Ester	Ethyl acetate	△		○	Benzene	○
	Bromine	○	×	Butyl acetate		○	○		Toluene	○	△
	Hydrogen peroxide	○	×	Alcohol		Methanol	○		△	Xylene	○
	Water	○	○		Ethanol	○	△	Cresol	○	×	
Ketone	Acetone	△	△		Propyl alcohol	○	△	Halides	Chloroform	○	△
	Methyl ethyl ketone	○	△		Hydrocarbon	Hexane	○		○	Carbon tetrachloride	○
	Methyl isobutyl ketone	○	△	Mineral oil ASTM No.3		○	○		Trichloroethylene	○	△
			Octane	○		○	Tetrachloroethylene		○	△	
			Cyclohexane	○	○	Ether	Tetrahydrofuran	△	△		
							Cellulosolve	△	△		

Tubing

Clean tubing

Processed tubing

PushOne fitting

QuickSeal fitting

Clean fitting/Chemifit

Bamboo-shoot fitting

Control switch/Detachable series

Jig/Tool/Accessory

Technical information

Reference

(1) Test items and applied standard for pneumatic fitting

<Standard No.>
JIS B 8381-1995

<Test items>

- ① Flow rate characteristics test (effective cross-sectional area)
- ② Airtight test
- ③ Pressure resistance test
- ④ Repeated connection test
- ⑤ Pulling strength test
- ⑥ Durability test

(2) Test items and applied standard for pneumatic fitting tubing (nylon tubing, polyurethane tubing).

<Standard No.>
JIS B 8381-1995 Appendix

<Test items>

- ① Minimum bending radius test
- ② Impact pressure test
- ③ Durability test

(3) Test items and applied standard for speed controller

<Standard No.>
JIS B 8376-1982, JIS B 8381-1995

<Test items>

- ① Controlled flow rate characteristics test
- ② Free flow rate characteristics test
- ③ Pressure resistance test
- ④ Cracking pressure test of valve
- ⑤ Leaking test of valve
- ⑥ Durability test

Screw Standard List

Parallel Pipe Threads (JIS B 0202-1999)

1. Basic profile

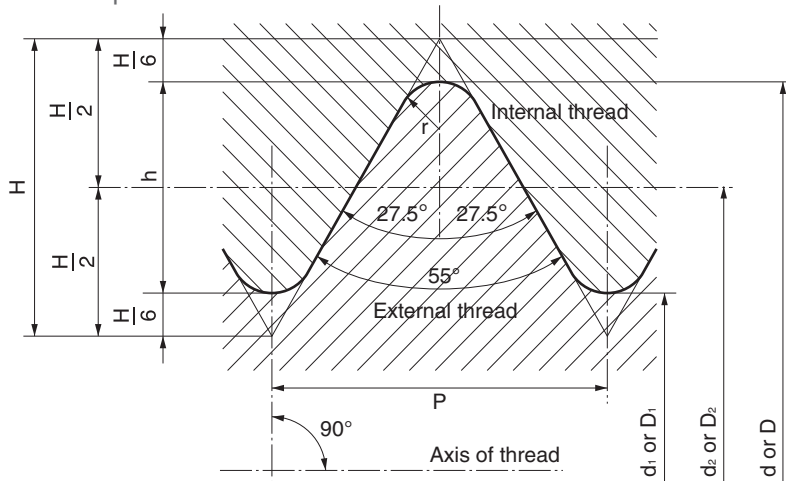

Thick continuous line shows basic profile.

$$P = \frac{25.4}{n}$$

$$H = 0.960491P$$

$$h = 0.640327P$$

$$r = 0.137329P$$

$$d_2 = d - h \quad D_2 = d_2$$

$$d_1 = d - 2h \quad D_1 = d_1$$

$$D = d$$

2. Basic sizes

(Unit:mm)

Designation of thread	Number of threads (per 25.4mm) n	Pitch P	Height of thread h	Radius r	External thread		
					Major dia. d	Pitch dia. d ₂	Minor dia. d ₁
					Internal thread		
					Major dia. D	Pitch dia. D ₂	Minor dia. D ₁
G 1/16	28	0.9071	0.581	0.12	7.723	7.142	6.561
G 1/8	28	0.9071	0.581	0.12	9.728	9.147	8.566
G 1/4	19	1.3368	0.856	0.18	13.157	12.301	11.445
G 3/8	19	1.3368	0.856	0.18	16.662	15.806	14.950
G 1/2	14	1.8143	1.162	0.25	20.955	19.793	18.631
G 5/8	14	1.8143	1.162	0.25	22.911	21.749	20.587
G 3/4	14	1.8143	1.162	0.25	26.441	25.279	24.117
G 7/8	14	1.8143	1.162	0.25	30.201	29.039	27.877
G 1	11	2.3091	1.479	0.32	33.249	31.770	30.291

About thread standard

The above standard is an excerpt from a standard table issued by the Japan Standards Association. For design and trade, be sure to check the appropriate updated standard table.

Tubing

Clean tubing

Processed tubing

PushOne fitting

QuickSeal fitting

Clean fitting/Chemfit

Bamboo-shoot fitting

Control switch/Detachable series

Jig/Tool/Accessory

Technical information

Reference

Taper Pipe Threads (JIS B 0203-1999)

1. Basic profile

Basic profile applied for taper external and taper internal threads.

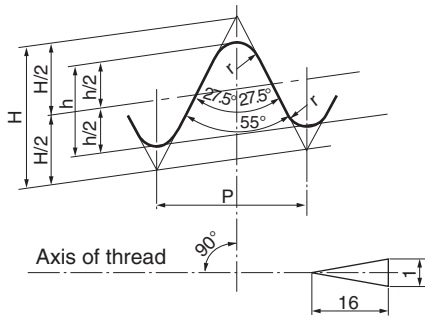

Thick continuous line shows basic profile.

$$P = \frac{25.4}{n} \quad h = 0.640327P$$

$$H = 0.960237P \quad r = 0.137278P$$

Basic profile applied for parallel internal threads.

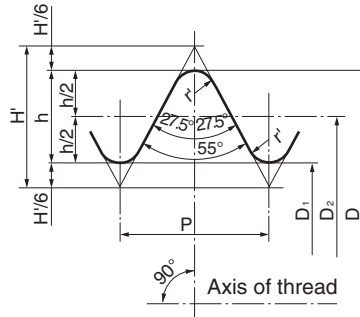

Thick continuous line shows basic profile.

$$P = \frac{25.4}{n} \quad h = 0.640327P$$

$$H' = 0.960491P \quad r' = 0.137329P$$

Fit between taper external thread and taper internal or parallel internal thread.

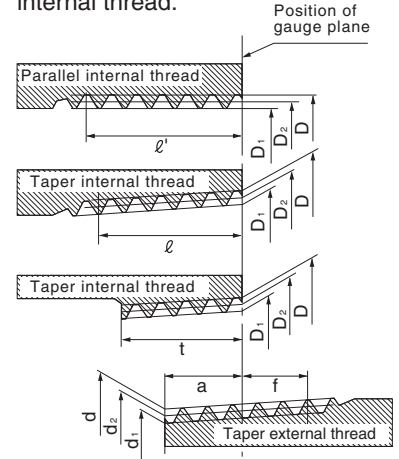

2. Basic size

(Unit:mm)

Designation of thread (PT)	Thread				Gauge dia.			Position of gauge plane			Tolerance on D, D ₂ and D ₁ of parallel internal thread	Length of useful thread (min.)			
	Number of threads (per 25.4mm)	Pitch	Height of thread	Radius	External thread			External thread		Internal thread		From position of gauge plane toward larger dia. end f	Internal thread		
					Major dia. d	Pitch dia. d ₂	Minor dia. d ₁	From pipe end		At pipe end			When there is incomplete thread part		
								Major dia. D	Pitch dia. D ₂				Minor dia. D ₁	Gauge length	Axial tolerance
R1/16	28	0.9071	0.581	0.12	7.723	7.142	6.561			3.97	±0.91	±1.13		±0.071	2.5
R1/8	28	0.9071	0.581	0.12	9.728	9.147	8.566	3.97	±0.91	±1.13	±0.071	2.5	6.2	7.4	4.4
R1/4	19	1.3368	0.856	0.18	13.157	12.301	11.445	6.01	±1.34	±1.67	±0.104	3.7	9.4	11.0	6.7
R3/8	19	1.3368	0.856	0.18	16.662	15.806	14.950	6.35	±1.34	±1.67	±0.104	3.7	9.7	11.4	7.0
R1/2	14	1.8143	1.162	0.25	20.955	19.793	18.631	8.16	±1.81	±2.27	±0.142	5.0	12.7	15.0	9.1
R3/4	14	1.8143	1.162	0.25	26.441	25.279	24.117	9.53	±1.81	±2.27	±0.142	5.0	14.1	16.3	10.2
R1	11	2.3091	1.479	0.32	33.249	31.770	30.291	10.39	±2.31	±2.89	±0.181	6.4	16.2	19.1	11.6

Metric Coarse Screw Threads (JIS B 0205-1987)

1. Basic profile

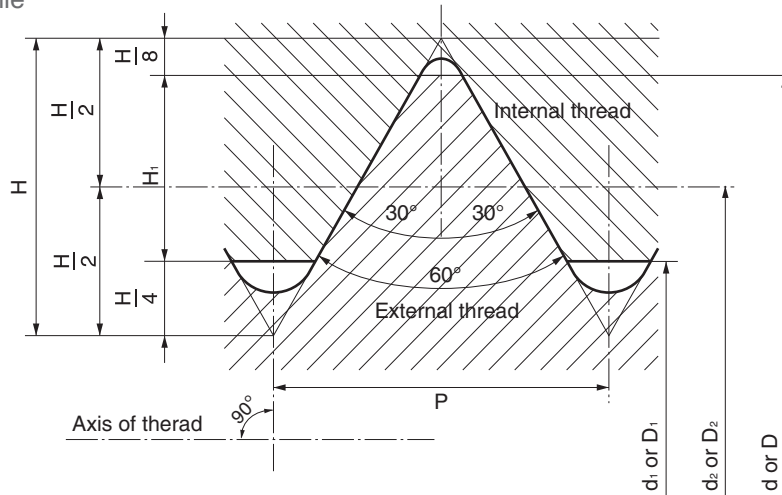

$$H=0.866025P$$

$$H_1=0.541266P$$

$$d_2=d-0.649519P$$

$$d_1=d-1.082532P$$

$$D=d$$

$$D_2=d_2$$

$$D_1=d_1$$

2. Basic sizes

(Unit:mm)

Designation of thread			Pitch	Thread overlap H_1	External thread		
					Major dia. d	Pitch dia. d_2	Minor dia. d_1
Primary	Secondary	Tertiary	P	H_1	Internal thread		
					Major dia. D	Pitch dia. D_2	Minor dia. D_1
M3	M3.5		0.5	0.271	3.000	2.675	2.459
			0.6	0.325	3.500	3.110	2.850
M4	M4.5		0.7	0.379	4.000	3.545	3.242
			0.75	0.406	4.500	4.013	3.688
M5			0.8	0.433	5.000	4.480	4.134
M6			1	0.541	6.000	5.350	4.917
M8		M7	1	0.541	7.000	6.350	5.917
			1.25	0.677	8.000	7.188	6.647
		M9	1.25	0.677	9.000	8.188	7.647
M10			1.5	0.812	10.000	9.026	8.376
			1.5	0.812	11.000	10.026	9.376
M12		M11	1.75	0.947	12.000	10.863	10.106
M16	M14		2	1.083	14.000	12.701	11.835
			2	1.083	16.000	14.701	13.835
	M18		2.5	1.353	18.000	16.376	15.294
M20			2.5	1.353	20.000	18.376	17.294
			2.5	1.353	22.000	20.376	19.294
M24			3	1.624	24.000	22.051	20.752
			3	1.624	27.000	25.051	23.752
M30	M27		3.5	1.894	30.000	27.727	26.211

Tubing

Clean tubing

Processed tubing

PushOne fitting

QuickSeal fitting

Clean fitting/Chemifit

Bamboo-shoot fitting

Control switch/Detachable series

Jig/Tool/Accessory

Technical information

Reference

Metric Fine Screw Threads (JIS B 0207-1987)

1. Basic profile

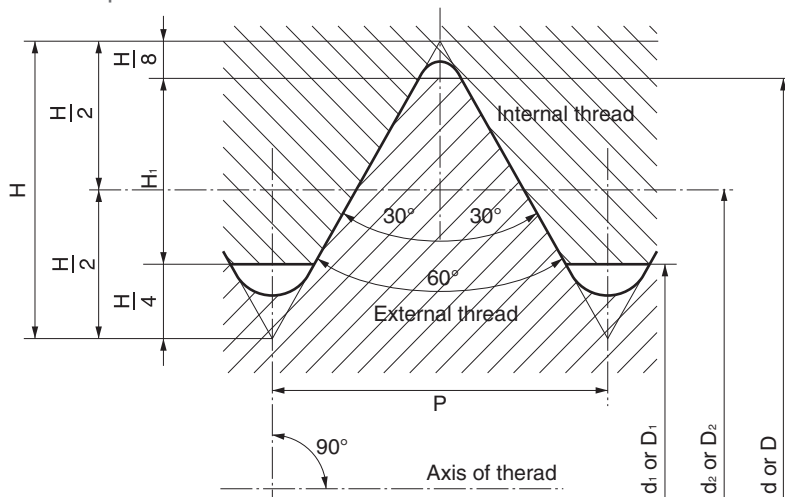

$$H=0.866025P$$

$$H_1=0.541266P$$

$$d_2=d-0.649519P$$

$$d_1=d-1.082532P$$

$$D=d$$

$$D_2=d_2$$

$$D_1=d_1$$

2. Basic sizes

(Unit:mm)

Designation of thread	Pitch P	Thread overlap H ₁	External thread		
			Major dia. d	Pitch dia. d ₂	Minor dia. d ₁
			Internal thread		
			Major dia. D	Pitch dia. D ₂	Minor dia. D ₁
M3×0.35	0.35	0.189	3.000	2.773	2.621
M3.5×0.35	0.35	0.189	3.500	3.273	3.121
M4×0.5	0.5	0.271	4.000	3.675	3.459
M4.5×0.5	0.5	0.271	4.500	4.175	3.959
M5×0.5	0.5	0.271	5.000	4.675	4.459
M5.5×0.5	0.5	0.271	5.500	5.175	4.959
M6×0.75	0.75	0.406	6.000	5.513	5.188
M7×0.75	0.75	0.406	7.000	6.513	6.188
M8×1	1	0.541	8.000	7.350	6.917
M8×0.75	0.75	0.406	8.000	7.513	7.188
M9×1	1	0.541	9.000	8.350	7.917
M9×0.75	0.75	0.406	9.000	8.513	8.188
M10×1.25	1.25	0.677	10.000	9.188	8.647
M10×1	1	0.541	10.000	9.350	8.917
M10×0.75	0.75	0.406	10.000	9.513	9.188
M11×1	1	0.541	11.000	10.350	9.917
M11×0.75	0.75	0.406	11.000	10.513	10.188
M12×1.5	1.5	0.812	12.000	11.026	10.376
M12×1.25	1.25	0.677	12.000	11.188	10.647
M12×1	1	0.541	12.000	11.350	10.917
M14×1.5	1.5	0.812	14.000	13.026	12.376
M14×1.25	1.25	0.677	14.000	13.188	12.647
M14×1	1	0.541	14.000	13.350	12.917
M15×1.5	1.5	0.812	15.000	14.026	13.376
M15×1	1	0.541	15.000	14.350	13.917
M16×1.5	1.5	0.812	16.000	15.026	14.376
M16×1	1	0.541	16.000	15.350	14.917
M17×1.5	1.5	0.812	17.000	16.026	15.376
M17×1	1	0.541	17.000	16.350	15.917
M18×2	2	1.083	18.000	16.701	15.835
M18×1.5	1.5	0.812	18.000	17.026	16.376
M18×1	1	0.541	18.000	17.350	16.917
M20×2	2	1.083	20.000	18.701	17.835
M20×1.5	1.5	0.812	20.000	19.026	18.376
M20×1	1	0.541	20.000	19.350	18.917
M22×2	2	1.083	22.000	20.701	19.835
M22×1.5	1.5	0.812	22.000	21.026	20.376
M22×1	1	0.541	22.000	21.350	20.917
M24×2	2	1.083	24.000	22.701	21.835
M24×1.5	1.5	0.812	24.000	23.026	22.376
M24×1	1	0.541	24.000	23.350	22.917
M25×2	2	1.083	25.000	23.701	22.835
M25×1.5	1.5	0.812	25.000	24.026	23.376
M25×1	1	0.541	25.000	24.350	23.917
M26×1.5	1.5	0.812	26.000	25.026	24.376
M27×2	2	1.083	27.000	25.701	24.835
M27×1.5	1.5	0.812	27.000	26.026	25.376
M27×1	1	0.541	27.000	26.350	25.917
M28×2	2	1.083	28.000	26.701	25.835
M28×1.5	1.5	0.812	28.000	27.026	26.376
M28×1	1	0.541	28.000	27.350	26.917
M30×3	3	1.624	30.000	28.051	26.752
M30×2	2	1.083	30.000	28.701	27.835
M30×1.5	1.5	0.812	30.000	29.026	28.376
M30×1	1	0.541	30.000	29.350	28.917

UL-94 Standard Flame Test

UL (Underwriters Laboratories Inc.) is a non-profit test organization established in 1894 by an American insurance company mainly to respond to the need for improving safety in electric, and later electronic, instruments.

Major tasks are various regulations on raw materials, parts, unfinished products and finished products, as well as creation, examination, certification and registration of safety test standards. It has a major influence with a world-wide network.

UL-94 standard (Tests for Flammability of Plastic Materials for Parts in Devices and Appliances) is the most fundamental one among several UL standards for plastic materials flammability tests.

UL-94 standard has various test methods and flammability classes. Here we introduce self-extinguishing material classes V-0, V-1 and V-2 from the tests for flammability class of materials such as injection-molding grade, extruded plate and press-molded plate.

The flammability of general nylon and the material of the polyurethane tubing are tested by UL-94 HB to examine the combustion velocity.

	94 V-0	94 V-1	94 V-2
Specimen	A set of five specimens processed for 48 hours at 23±2 °C and RH50±5%, and a set of five specimens processed for 168 hours at 70±1 °C, each of which is 5 inch (127mm) long, 0.5 inch (12.7mm) wide with the maximum thickness under 0.5 inch.		
Test method	<ul style="list-style-type: none"> ● Conduct a test with no draft. ● Prepare a 3/4 inch-high blue burner flame with no yellow tip. ● Apply the adjusted flame to a specimen for 10 seconds and remove. Observe the specimen burning. When the burning stops, reapply the flame for an additional 10 seconds. 		
Requirements	<p>A. The specimens may not burn with flaming combustion for more than 10 seconds after either application of the test flame.</p> <p>B. The total flaming combustion time may not exceed 50 seconds for the 10 flame applications for each set of five specimens.</p> <p>C. The specimens may not burn with flaming or glowing combustion up to the holding clamp.</p> <p>D. The specimens may not drip flaming particles that ignite the surgical cotton located 12 inches below the test specimen.</p> <p>E. The specimens may not have glowing combustion that persists for more than 30 seconds after the second removal of the test flame.</p>	<p>A. The specimens may not burn with flaming combustion for more than 30 seconds after either application of the test flame.</p> <p>B. The total flaming combustion time may not exceed 250 seconds for the 10 flame applications for each set of five specimens.</p> <p>C. The specimens may not burn with flaming or glowing combustion up to the holding clamp.</p> <p>D. The specimens may not drip flaming particles that ignite the surgical cotton located 12 inches below the test specimen.</p> <p>E. The specimens may not have glowing combustion that persists for more than 60 seconds after the second removal of the test flame.</p>	<p>A. The specimens may not burn with flaming combustion for more than 30 seconds after either application of the test flame.</p> <p>B. The total flaming combustion time may not exceed 250 seconds for the 10 flame applications for each set of five specimens.</p> <p>C. The specimens may not burn with flaming or glowing combustion up to the holding clamp.</p> <p>D. The specimens can drip flaming particles that ignite the surgical cotton below the test specimen.</p> <p>E. The specimens may not have glowing combustion that persists for more than 60 seconds after the second removal of the test flame.</p>
	<p>If any one of five specimens does not meet the requirements and if the total flaming combustion time is in the range below (*), test another set of five specimens. The second set has to meet all the requirements.</p> <p style="text-align: center;">*94V-0 51-55 seconds, 94V-1 251-255 seconds, 94V-2 251-255 seconds</p>		

About UL standard

The above is extracted from UL standards as reference.

See the appropriate latest original standards for design and trade.

Table of Full Scale of Tubing and Screw

The size of the tubing and thread can be easily checked by placing the product on the following full-scale figures.

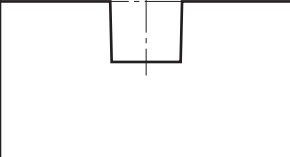
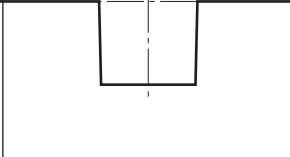
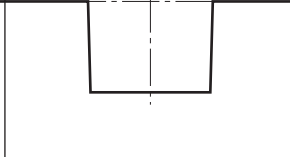
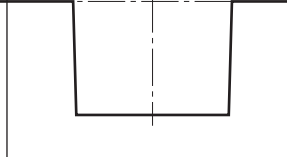

● Taper pipe threads

Thread size	R1/8	R1/4	R3/8	R1/2
Full scale				

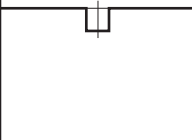
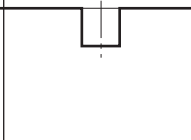
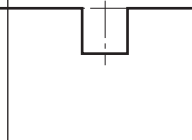
● Metric threads

Thread size	M3×0.5	M5×0.8	M6×1.0
Full scale			

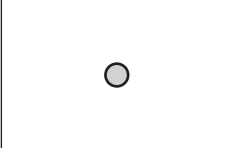
● Tubing (outer diameter)

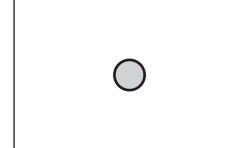
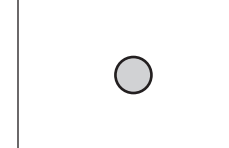
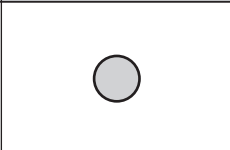
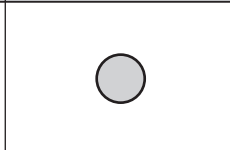
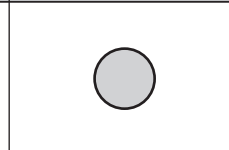
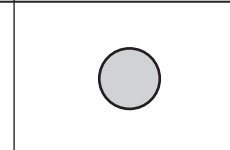
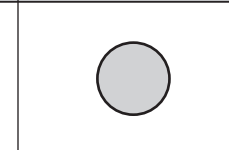
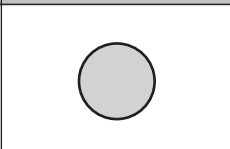
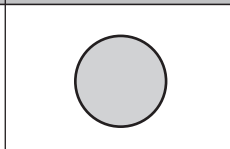
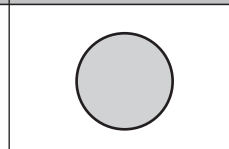
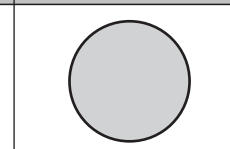
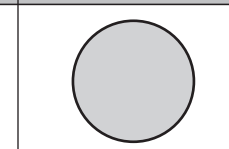
Millimeter size	φ3	—	φ3.5	φ4	—
Inch size	—	1/8 (φ3.18)	—	—	3/16 (φ4.76)
Full scale					
Millimeter size	φ6	—	—	φ8	—
Inch size	—	1/4 (φ6.35)	5/16 (φ7.94)	—	3/8 (φ9.53)
Full scale					
Millimeter size	φ10	φ12	—	—	φ16
Inch size	—	—	1/2 (φ12.70)	5/8 (φ15.88)	—
Full scale					

Unit Conversion Table

Length

m	inch	foot	yard	mile
1	3.937×10	3.2808	1.0936	6.2×10 ⁻⁴
2.54×10 ⁻²	1	8.3333×10 ⁻²	2.778×10 ⁻²	1.6×10 ⁻⁵
3.048×10 ⁻¹	1.2×10	1	3.3333×10 ⁻¹	1.9×10 ⁻⁴
9.114×10 ⁻¹	3.6×10	3	1	5.7×10 ⁻⁴
1.6093×10 ³	6.3360×10 ⁴	5.280×10 ³	1.760×10 ³	1

Weight

kg	ton(UK)	ton(US)	lb	Ounce
1	9.842×10 ⁻⁴	1.1023×10 ⁻³	2.2046	3.5274×10
1.016×10 ³	1	1.12	2.240×10 ³	3.5838×10 ⁴
9.072×10 ²	8.9286×10 ⁻¹	1	2×10 ³	3.2×10 ⁴
4.536×10 ⁻¹	4.464×10 ⁻⁴	5×10 ⁻⁴	1	1.6×10
2.835×10 ⁻²	2.79×10 ⁻⁵	3.13×10 ⁻⁵	6.25×10 ⁻²	1

Pressure

Pa	MPa	bar	kgf/cm ²	psi	mmHg
1	1×10 ⁻⁶	1×10 ⁻⁵	1.0197×10 ⁻⁵	1.4504×10 ⁻⁴	7.5006×10 ⁻³
1×10 ⁵	1×10 ⁻¹	1	1.0197	1.4504×10	7.5006×10 ²
9.8067×10 ⁴	9.8067×10 ⁻²	9.8067×10 ⁻¹	1	1.4223×10	7.3556×10 ²
6.8948×10 ³	6.8948×10 ⁻³	6.4898×10 ⁻²	7.0307×10 ⁻²	1	5.1715×10
1.3332×10 ²	1.3332×10 ⁻⁴	1.332×10 ⁻³	1.3595×10 ⁻³	1.934 ¹ ×10 ⁻²	1

Force

N	dyn	kgf
1	1×10 ⁵	1.0197×10 ⁻¹
1×10 ⁻⁵	1	1.0197×10 ⁻⁶
9.8066	9.8066×10 ⁵	1

* Å† presents SI units.

Tubing

Clean tubing

Processed tubing

PushOne fitting

QuickSeal fitting

Clean fitting/Chemifit

Bamboo-shoot fitting

Control switch/Detachable series

Jig/Tool/Accessory

Technical information

Reference

Chemical Resistance Specification Table (alphabetical order)

[How to read the table]

- The table shows chemical resistance of materials, not of Nitta's products (finished products). Therefore the table does not guarantee the chemical resistance performance of the products.
- The table is created under certain conditions. The symbol [○] does not always mean chemical resistance depending on the environment, condition, and duration of use. Be sure to check under the actual conditions of use.
- Test is conducted for saturated solutions of chemicals in the table at room temperature unless specifically indicated.
- The table does not present permeability for gas chemicals. Chemicals that are toxic when permeating, such as activated gas, cannot be used for Nitta's products.
- Contact us for chemical resistance of plated and seal-processed parts.

[Contact us]

Before contacting us, check 1. the maximum working pressure, 2. working temperature range, 3. chemical concentration, 4. piping state (environmental state), and 5. use application, and then contact us or our regional office.

[Criteria]

- : Can be used with no influence, or almost no influence on material
- △: Can be used although having influence to a certain degree on material. Sufficient check is required.
- ×: Cannot be used.
- : No data.

Chemical Resistance Specification Table (for reference)

Test is conducted for saturated solutions of chemicals in the table at room temperature unless specifically indicated.

Chemical (weight concentration %, temperature °C)	Tubing material				Fitting material				Seal material			
	Polyurethane	Nylon	Polyolefin	Fluorocarbon resin	Brass	SUS304	SUS316	PBT	PP	NBR	EPDM	FKM
2-Aminophenyl Disulfide	△	○	○	—	—	—	—	—	—	—	—	—
Acetaldehyde	×	△	×	×	○	○	○	△	△	×	△	×
Acetic Acid (10%, 20°C)	×	△	○	○	×	△	○	△	○	×	—	—
Acetic Acid (50%, 20°C)	×	×	△	○	×	△	△	△	×	×	—	△
Acetic Acid (50%, 70°C)	×	×	×	○	×	△	△	△	×	×	—	△
Acetic Acid (100%, 20°C)	×	×	×	○	×	△	△	△	×	×	—	△
Acetic Anhydride	×	×	△	○	×	△	△	—	△	×	△	×
Acetoamide	—	—	×	○	—	—	—	△	△	○	○	△
Acetone	×	△	△	○	○	△	△	△	×	×	△	×
Acetyl Bromide	×	×	×	○	—	—	—	—	—	×	○	○
Acetyl Chloride	×	×	×	—	—	—	△	—	—	—	—	—
Acetylene	○	○	○	○	×	○	○	○	○	○	○	○
Acrylonitrile	—	—	△	○	△	△	△	△	—	×	—	×
Alum	—	×	○	○	—	—	—	—	○	○	—	—
Aluminium Acetate	—	○	○	○	—	—	—	△	○	△	○	×
Aluminium Bromide	—	△	○	○	—	—	—	—	○	○	○	○
Aluminium Chloride	—	△	○	○	×	×	×	△	○	○	○	○
Aluminium Fluoride	—	△	○	○	○	×	×	—	○	○	○	○
Aluminium Nitrate	△	△	○	○	—	—	△	△	○	○	○	○
Aluminium Sulfate	—	○	○	○	×	○	○	△	○	○	○	○
Ammonia Anhydrous	—	○	○	○	×	○	○	△	○	○	○	×
Ammonia Gas Cold	×	×	×	×	×	○	○	△	—	○	○	×
Ammonia Gas Hot	×	×	×	×	×	△	△	×	—	△	○	×
Ammonia Liquid	—	○	○	○	△	○	○	△	△	△	—	—
Ammonia Water	△	△	○	○	×	△	△	△	—	—	—	—
Ammonium Carbonate	—	○	○	○	—	△	△	△	○	×	○	○
Ammonium Chloride	○	○	○	○	×	△	△	△	○	○	○	○
Ammonium Hydroxide	△	△	○	○	×	△	△	×	○	×	○	○
Ammonium Nitrate	○	○	○	○	×	△	△	△	○	○	○	—
Ammonium Persulphate	—	○	○	○	—	—	—	—	—	—	—	—
Ammonium Phosphate	○	○	○	○	△	△	△	△	○	○	—	—
Ammonium Sulfate	○	○	○	○	△	△	△	△	○	○	○	×
Amyl Acetate	×	○	×	○	△	—	○	△	×	×	△	×
Amyl Alcohol	△	△	△	△	△	—	—	△	△	△	○	○
Amyl Borate	—	—	△	○	—	—	—	—	△	○	×	○

Chemical Resistance Specification Table (for reference)

Test is conducted for saturated solutions of chemicals in the table at room temperature unless specifically indicated.

	Chemical (weight concentration %, temperature °C)	Tubing material				Fitting material				Seal material			
		Polyurethane	Nylon	Polyolefin	Fluorocarbon resin	Brass	SUS304	SUS316	PBT	PP	NBR	EPDM	FKM
A	Amyl Naphthalene	—	—	△	○	—	—	—	○	△	×	—	—
	Anethole	—	○	—	○	—	—	—	—	—	—	—	—
	Aniline	×	×	×	○	×	△	△	△	×	×	△	△
	Aniline Dyes	—	×	○	○	—	—	—	△	○	×	△	△
	Animal Oil (Lard Oil)	○	○	○	○	○	—	△	○	○	○	△	○
	Aqua Regia	×	×	×	○	—	—	—	×	×	×	△	○
	Arsenic Acid	—	△	○	○	△	△	△	—	○	—	—	—
	Asphalt	○	○	○	○	○	○	○	—	○	○	×	○
	ASTM Lubricant No.1	○	○	×	○	○	○	○	○	△	○	×	○
	ASTM Lubricant No.2	×	○	×	○	○	○	○	○	△	○	×	○
	ASTM Lubricant No.3	×	○	×	○	○	○	○	○	△	△	×	○
	ASTM Standard Fuel Oil A	○	○	×	○	○	○	○	○	△	○	×	○
	ASTM Standard Fuel Oil B	○	○	×	○	○	○	○	○	△	○	×	○
	ASTM Standard Fuel Oil C	○	○	×	○	○	○	○	○	△	○	×	○
B	Balium Hydroxide	—	○	○	○	×	—	○	△	○	○	○	○
	Barium Chloride	○	○	○	○	×	—	△	△	○	○	○	○
	Barium Sulfate	—	○	○	○	△	△	△	△	○	○	○	○
	Barium Sulfide	—	○	○	○	—	—	△	△	○	○	○	○
	Beet Sugar liquid	—	○	○	○	×	—	○	—	○	○	—	—
	Benzoaldehyde	△	△	×	○	△	△	△	—	×	×	—	×
	Benzene	×	△	×	○	×	△	△	△	×	×	×	△
	Benzine	△	△	×	○	—	—	—	△	×	○	—	○
	Benzoic Acid	×	○	○	○	△	△	△	△	—	—	—	—
	Benzyl Alcohol	△	△	△	○	△	△	△	△	—	×	○	○
	Benzyl Benzoate	—	—	—	○	—	—	—	△	—	×	×	○
	Benzyl Chloride	—	×	—	○	—	—	×	—	—	×	×	○
	Borax	○	○	○	○	×	—	○	—	○	△	○	○
	Boric Acid	○	○	○	○	△	△	△	△	○	○	○	○
	Bromine	×	×	×	○	×	—	×	×	—	×	×	○
	Bunker Fuel	—	○	—	○	△	—	○	—	—	○	—	—
	Butane	—	○	△	○	○	○	○	○	○	○	×	○
	Butyl Acetate	×	○	×	○	△	—	△	△	×	×	△	×
	Butyl Acrylate	—	○	×	○	—	—	—	△	△	×	—	×
	Butyl Alcohol	△	△	△	○	○	○	○	△	—	△	△	○
	Butyl Cellosolve	—	△	—	—	△	—	△	○	—	△	—	—
	Butyl Stearate	—	○	—	○	—	—	—	△	—	△	×	○
C	Calcium Acetate	○	○	○	○	△	—	△	△	○	○	○	×
	Calcium Arsenate	○	○	○	—	—	—	—	△	—	△	○	△
	Calcium Bisulfite	○	○	○	○	×	—	△	△	—	—	—	—
	Calcium Chloride	○	○	○	○	○	△	△	△	○	○	○	○
	Calcium Hydroxide	△	○	○	○	△	△	△	×	○	○	○	○
	Calcium Hypochlorite (20%, 20°C)	×	×	○	○	×	—	△	△	○	—	—	—
	Calcium Nitrate	—	○	○	○	—	—	—	△	○	○	○	○
	Calcium Sulfide	—	○	○	○	—	—	△	△	○	○	○	○
	Cane Sugar Liquor	—	○	○	○	○	—	○	○	○	○	○	—
	Carbitol	—	—	△	—	△	—	△	—	—	○	—	—
	Carbon Dioxide	○	○	○	○	○	○	○	○	○	○	—	—
	Carbon Disulfide	×	×	×	○	○	○	○	—	×	△	×	○
	Carbon Oxide	○	○	○	○	○	○	○	△	—	○	○	○
	Carbon Tetrachloride	×	×	×	△	△	△	△	×	×	×	×	○
	Carbonic Acid	△	○	△	○	○	△	△	—	△	△	○	○
	Castor Oil	△	○	○	○	○	△	△	△	—	○	△	○
	Cellosolve	—	○	○	○	△	—	△	○	×	○	×	×
	Cellosolve Acetate	×	△	—	—	—	—	—	△	—	×	○	×
	Chlorine Gas (dry)	×	×	×	△	△	×	×	×	×	△	×	○
	Chlorine Gas (wet)	×	×	×	△	×	×	×	×	×	×	×	△
	Chloro Acetone	—	—	×	—	—	—	—	—	×	×	○	×
	Chloroform	×	△	×	○	△	△	△	△	×	×	×	○
	Chlorosulfonic Acid	—	×	×	○	△	×	×	△	×	×	×	×
	Chlorotoluene	—	×	×	○	—	—	—	△	×	×	×	○

Chemical Resistance Specification Table (for reference)

Test is conducted for saturated solutions of chemicals in the table at room temperature unless specifically indicated.

	Chemical (weight concentration %, temperature °C)	Tubing material				Fitting material				Seal material			
		Polyurethane	Nylon	Polyolefin	Fluorocarbon resin	Brass	SUS304	SUS316	PBT	PP	NBR	EPDM	FKM
C	Chromic Acid (2%, 50°C)	×	×	×	○	×	×	△	△	—	—	—	—
	Chromic Acid (2%, 70°C)	×	×	×	○	×	×	△	×	△	×	○	○
	Chromic Acid (10%, 70°C)	×	×	×	○	×	×	△	×	×	×	—	○
	Chromic Acid (25%, 70°C)	×	×	×	△	×	×	△	×	×	×	×	○
	Citric Acid	△	○	○	○	△	△	△	×	○	○	○	○
	Coal-Tar	○	○	△	○	△	○	○	—	△	○	—	—
	Copper Chloride	○	△	○	○	×	×	×	△	—	○	○	○
	Copper Cyanide	—	○	○	○	—	—	○	△	○	○	○	○
	Copper Sulfate	○	○	○	○	○	△	○	△	○	○	○	○
	Corn Oil	○	○	△	○	×	—	○	○	○	○	—	—
	Cotton Seed Oil	○	○	△	○	△	△	△	—	△	○	△	○
	Creosote	×	×	△	○	△	△	△	—	—	○	—	○
	Cresol	×	×	×	○	△	△	○	△	△	×	×	○
	D	Cyclohexane	△	○	×	○	△	—	△	○	×	○	×
Cyclohexanol		—	○	△	○	△	△	△	△	△	△	×	○
Cyclohexanone		×	○	×	○	—	—	—	△	×	×	△	×
Decalin		—	○	△	○	—	—	—	—	—	×	×	○
Developer		△	△	○	○	—	—	—	△	○	○	△	○
Diacetone Alcohol		△	○	○	○	△	○	○	—	—	×	○	×
Dibenzine Ether		×	△	×	△	○	—	○	—	×	×	△	×
Dibutyl Ether		△	△	×	○	—	—	—	△	×	×	×	△
Dibutyl Phthalate		△	○	△	○	—	—	—	△	△	×	○	△
Dichlorobenzene		×	△	×	○	△	—	—	△	×	×	×	○
Diethanol Amine		△	○	—	—	—	—	○	△	—	—	—	—
Diethyl Ether		△	△	△	○	△	—	△	△	—	×	×	×
Diethyl Sebacate		—	△	×	○	—	—	—	△	×	△	△	△
Diisopropyl Ketone		×	△	△	○	—	—	—	△	×	×	—	—
E	Dimethyl Formamide	×	×	△	△	△	—	—	△	×	×	×	×
	Dinitrogen Oxide (Nitrous Oxide)	×	○	×	○	×	△	○	△	—	—	—	—
	Diethyl Phthalate (DOP)	△	○	×	○	—	—	—	△	△	○	○	○
	Diethyl Sebacate (DOS)	△	○	×	○	—	—	—	○	△	×	—	△
	Dipentene (Limonene)	×	△	×	○	—	—	—	—	—	△	×	○
	Diphenyl	×	△	×	○	—	—	—	△	—	×	×	○
	Diphenyl Oxide	—	—	—	○	—	—	—	—	—	×	×	○
	Dowtherm(100°C)	—	—	—	○	—	—	—	—	—	×	—	○
	Dowtherm(200°C)	—	—	—	○	—	—	—	—	—	—	—	—
	Epichlorohydrin	—	×	—	○	—	—	—	—	—	×	△	×
	Ester Silicate	—	○	—	○	—	—	—	△	—	○	—	—
	Ethanol Amine	—	×	×	○	—	—	—	△	△	○	○	×
	Ethyl Acetate	×	○	△	○	△	△	△	△	×	×	△	×
	Ethyl Acetoacetate	—	—	—	○	—	—	—	△	—	×	△	×
Ethyl Acrylate	×	—	—	△	△	—	—	△	—	×	—	×	
Ethyl Alcohol	×	△	△	○	○	△	○	△	△	○	○	○	
Ethyl Benzene	—	—	×	○	△	○	○	△	×	×	×	○	
Ethyl Cellulose	—	—	○	○	—	—	△	○	○	○	○	×	
Ethyl Chloride	×	○	×	—	△	○	○	—	×	○	△	○	
Ethyl Ether (>Diethyl Ether)	△	△	△	○	△	○	○	△	—	—	—	—	
Ethyl Oxalate	×	○	×	○	—	—	—	△	—	×	○	△	
Ethyl Silicate	—	△	—	○	—	—	—	△	—	○	○	○	
Ethylene Chlorohydrin	×	×	×	○	—	—	—	—	×	×	△	△	
Ethylene Diamine	—	×	×	○	—	—	—	△	△	○	○	×	
Ethylene Dichloride	×	×	△	○	○	△	△	×	—	×	—	○	
Ethylene Glycol	○	○	○	○	△	△	△	△	△	○	○	○	
Ethylene Oxide	×	○	×	○	△	—	△	△	○	×	—	×	
F	Fatty Acids	△	○	×	○	△	△	○	△	×	△	×	○
	Ferric Chloride	—	△	○	○	×	×	×	△	○	○	○	○
	Ferric Nitrate	—	○	○	○	—	—	—	△	○	○	○	○
	Ferric Sulfate	○	○	○	○	×	△	△	△	○	○	○	○
	Fluorine	×	—	×	×	×	—	△	—	—	—	—	—
	Fluoroboric Acid	×	—	○	○	—	—	○	—	○	△	—	—

Chemical Resistance Specification Table (for reference)

Test is conducted for saturated solutions of chemicals in the table at room temperature unless specifically indicated.

	Chemical (weight concentration %, temperature °C)	Tubing material				Fitting material				Seal material			
		Polyurethane	Nylon	Polyolefin	Fluorocarbon resin	Brass	SUS304	SUS316	PBT	PP	NBR	EPDM	FKM
F	Formaldehyde (40%, 20°C)	X	X	△	○	△	△	△	—	○	X	△	○
	Formic Acid (25%, 20°C)	X	X	○	○	X	△	○	△	○	X	○	X
	Formic Acid (50%, 20°C)	X	X	○	○	X	△	○	—	○	X	—	—
	Formic Acid (90%, 20°C)	X	X	△	○	X	△	○	—	○	X	—	—
	Freon 11	—	△	—	△	○	○	○	○	—	○	—	△
	Freon 12	—	△	—	△	○	○	○	○	—	△	—	○
	Freon 21	—	△	—	△	○	○	○	○	—	X	—	—
	Freon 22	—	△	—	△	○	○	○	○	—	X	—	X
	Freon 113	—	△	—	△	○	○	○	○	—	○	—	○
	Freon 114	—	△	—	△	○	○	○	○	—	—	—	—
	Furan	—	X	—	△	—	—	—	△	—	X	X	○
	Furfural	X	X	X	○	△	△	△	△	X	X	○	X
	Furfuryl Alcohol	○	○	○	—	—	—	—	—	—	—	—	—
G	Gasoline	X	○	△	○	○	○	○	○	△	○	X	○
	Gelatine	○	○	○	○	○	○	○	△	○	○	○	○
	Glucose	○	○	○	○	○	○	○	○	○	○	—	—
	Glue	—	○	○	○	△	—	△	—	○	○	—	—
	Glycerine	△	○	○	○	△	○	○	○	○	○	○	○
	Grease	△	○	△	○	△	○	○	○	X	—	—	—
H	Heavy Water	○	○	○	○	—	—	—	△	—	○	○	—
	Heptane	○	○	X	—	○	○	○	△	—	○	X	○
	Hexane	△	○	X	○	△	△	△	○	X	○	X	○
	Hexyl Alcohol	—	△	△	○	—	—	—	△	△	○	X	○
	Hydrazine	—	△	△	△	—	—	—	—	—	△	○	X
	Hydrobromic Acid (20%, 20°C)	—	△	○	○	X	X	X	△	○	X	○	○
	Hydrobromic Acid (20%, 70°C)	—	X	△	○	X	X	X	△	○	—	—	—
	Hydrobromic Acid (37%, 20°C)	—	△	○	○	X	X	X	△	○	○	—	—
	Hydrochloric Acid (10%, 20°C)	X	△	○	○	X	X	X	△	○	○	○	○
	Hydrochloric Acid (20%, 20°C)	X	X	△	○	X	X	X	X	○	△	○	○
	Hydrochloric Acid (20%, 80°C)	X	X	X	○	X	X	X	X	△	X	○	○
	Hydrochloric Acid (38%, 20°C)	X	X	○	○	X	X	X	X	○	X	△	○
	Hydrocyanic Acid	—	X	○	○	X	—	○	△	○	△	○	○
	Hydrofluoric Acid (10%, 20°C)	X	X	△	○	△	X	X	△	○	X	—	—
	Hydrofluoric Acid (20%, 20°C)	X	X	△	○	△	X	X	△	○	X	—	—
	Hydrofluoric Acid (40%, 20°C)	X	X	△	○	△	X	X	△	○	X	—	—
	Hydrofluoric Acid (Anhydrous)	X	X	X	○	X	—	X	—	X	—	—	—
	Hydrogen	○	○	○	○	△	○	○	○	○	○	○	○
	Hydrogen Peroxide (5%, 20°C)	△	○	○	○	X	△	△	△	○	X	○	○
	Hydrogen Peroxide (5%, 50°C)	X	△	△	○	X	△	△	—	○	X	△	○
	Hydrogen Peroxide (30%, 20°C)	X	X	△	○	X	△	△	—	○	X	X	○
	Hydrogen Sulfide	—	△	○	○	△	△	△	△	○	X	○	X
	Hydroquinone	—	○	○	○	—	—	—	—	○	—	—	—
	Hypochlorous Acid	X	△	○	○	—	—	—	△	○	—	—	—
I	Isobutyl Alcohol	—	△	○	○	—	—	—	△	○	△	○	○
	Isocyanates	○	○	○	○	—	—	—	—	—	—	—	—
	Isooctane	X	○	X	○	○	△	△	○	—	○	X	○
	Isopropyl Acetate	△	○	X	○	○	—	△	△	X	X	—	—
	Isopropyl Alcohol	—	△	○	○	△	△	△	△	○	△	○	○
	Isopropyl Ether	—	△	△	○	○	△	△	△	△	○	—	—
J	JP Fuel Oil	△	△	X	○	○	○	○	—	△	—	—	—
K	Kerosene	○	○	△	○	○	○	○	○	X	○	X	○
	Ketones	△	○	○	○	△	△	△	△	—	—	—	—
L	Lacquer	△	△	△	○	—	—	—	△	X	X	X	X
	Lactic Acid	—	△	△	○	X	△	△	△	○	○	○	○
	Lard Oil	○	○	○	○	○	—	△	○	○	○	—	○
	Lead Acetate	—	○	○	○	—	△	—	△	○	△	○	X
	Lead Arsenate	○	○	○	—	—	—	—	—	—	△	○	△
	Lead Nitrate	—	○	○	○	—	—	—	△	○	○	○	—
	Lead Sulfamate	—	○	○	○	—	—	—	△	○	△	○	△
	Lead Sulfate	○	○	○	—	△	—	△	△	—	—	—	—

Tubing

Clean tubing

Processed tubing

PushOne fitting

QuickSeal fitting

Clean fitting/Chemifit

Bamboo-shoot fitting

Control switch/Detachable series

Jig/Tool/Accessory

Technical information

Reference

Chemical Resistance Specification Table (for reference)

Test is conducted for saturated solutions of chemicals in the table at room temperature unless specifically indicated.

	Chemical (weight concentration %, temperature °C)	Tubing material				Fitting material					Seal material		
		Polyurethane	Nylon	Polyolefin	Fluorocarbon resin	Brass	SUS304	SUS316	PBT	PP	NBR	EPDM	FKM
L	Linoleic Acid	—	△	△	○	—	—	—	—	○	△	—	—
	Linseed Oil	○	○	×	○	—	—	—	—	—	○	△	○
	Liquid Chlorine	×	×	×	△	—	—	—	×	×	×	×	△
	Liquidified Petroleum Gas	—	○	△	○	○	○	○	○	—	○	—	—
	Lubricant (Ether Type)	×	△	×	○	○	○	○	△	—	—	—	—
	Lubricant (Mineral Oil Type)	○	○	×	○	○	○	○	○	△	○	×	○
	Lye Solutions	—	○	○	○	—	—	—	△	—	△	○	○
M	Magnesium Chloride	○	○	○	○	×	×	×	△	○	○	○	○
	Magnesium Hydroxide	△	○	○	○	△	—	△	×	○	△	○	○
	Magnesium Sulfate	○	○	○	○	△	○	○	△	○	○	—	—
	Maleic Acid	△	○	○	○	—	△	△	—	○	×	×	○
	Malic Acid	—	○	○	○	△	△	△	△	○	○	△	○
	Mercaptan	—	—	×	○	—	—	—	—	—	○	×	○
	Mercuric Chloride	○	○	○	○	×	×	×	—	○	○	—	—
	Mercury	—	○	○	○	×	—	△	—	○	○	○	—
	Methane	○	○	○	○	○	—	△	○	—	○	×	○
	Methyl Acetate	×	○	△	○	○	—	○	△	×	×	△	×
	Methyl Alcohol	×	△	△	○	○	△	△	△	△	△	○	△
	Methyl Bromide	×	△	×	○	○	—	○	△	—	△	×	○
	Methyl Chloride	×	×	×	○	△	○	○	—	×	×	×	○
	Methyl Ethyl Ketone	×	△	△	○	○	△	△	△	×	×	△	×
	Methyl Isobutyl Ketone	×	△	△	○	△	—	△	△	×	×	△	×
	Methyl Metacrylate	—	○	×	○	—	—	—	△	×	×	×	×
	Methyl Sulfate	×	△	×	—	—	—	—	△	—	—	—	—
	Methylene Dichloride	×	×	△	○	—	—	—	×	×	×	×	△
	Mineral Oils	○	○	△	○	○	○	○	○	△	○	×	△
	Monochloro Benzene	×	×	×	○	—	—	—	—	×	×	×	○
	Monochloro Acetic Acid	×	×	×	○	—	—	—	△	△	×	—	—
	Monoethanol Amine	—	○	△	○	—	—	—	—	○	×	—	—
	N	n-Hexa Aldehyde	—	—	×	○	—	—	—	—	—	×	—
Naphtha		△	○	×	○	△	△	△	△	△	×	×	○
Naphthalene		△	○	△	○	△	—	△	△	○	×	×	○
Naphthenic Acid		—	—	○	○	—	—	—	△	○	△	×	○
Natural Gas		—	○	○	○	○	○	○	○	○	○	×	○
Nickel Acetate		—	○	○	○	—	—	△	△	○	△	○	×
Nickel Chloride		—	×	○	○	×	—	×	—	○	○	○	○
Nickel Sulfate		—	○	○	○	—	△	△	△	○	○	○	○
Nitric Acid (10%, 20°C)		×	×	○	○	×	△	○	×	○	×	○	○
Nitric Acid (10%, 70°C)		×	×	△	○	×	△	○	×	△	×	△	○
Nitric Acid (30%, 20°C)		×	×	△	○	×	△	○	×	○	×	△	○
Nitric Acid (30%, 70°C)		×	×	×	○	×	△	○	×	△	×	×	○
Nitric Acid (61%, 20°C)		×	×	×	○	×	△	○	×	×	×	×	○
Nitric Acid (fuming, 20°C)		×	×	×	○	×	△	○	×	×	×	×	△
Nitrobenzene		×	×	×	○	△	△	△	—	×	×	△	△
Nitroethane		—	—	×	○	—	—	—	—	×	×	△	×
Nitrogen		○	○	○	○	○	○	○	○	○	○	○	○
Nitromethane		—	—	×	○	—	—	—	—	×	×	△	×
Nitropropane		—	—	×	○	—	—	—	—	×	×	—	×
O	Octyl Alcohol	—	×	△	○	△	—	△	△	○	△	△	○
	Oleic Acid	△	○	△	○	△	△	△	○	△	○	×	○
	Olive Oil	○	○	○	○	△	○	○	○	△	○	△	○
	Oxalic Acid	△	○	○	○	×	×	×	△	○	△	○	○
	Oxygene	△	△	△	○	○	○	○	△	○	△	○	○
	Ozone	△	△	△	○	△	△	○	○	—	×	○	○
P	Palm Oil	—	○	△	○	△	—	△	—	○	—	△	—
	Palmitic Acid	○	○	○	○	△	△	△	△	○	○	—	—
	Pentane	○	○	×	—	△	—	△	△	—	—	—	—
	Perchloric Acid	×	×	△	○	×	×	×	△	×	×	○	○
	Perchloroethylene	×	×	×	○	△	—	△	×	×	△	×	○
	Petroleum	○	○	×	○	—	—	—	△	△	○	×	○

Chemical Resistance Specification Table (for reference)

Test is conducted for saturated solutions of chemicals in the table at room temperature unless specifically indicated.

	Chemical (weight concentration %, temperature °C)	Tubing material				Fitting material				Seal material			
		Polyurethane	Nylon	Polyolefin	Fluorocarbon resin	Brass	SUS304	SUS316	PBT	PP	NBR	EPDM	FKM
P	Phenol	X	X	△	○	△	△	△	△	—	X	○	○
	Phenyl Disulfide	△	○	X	—	—	—	—	—	—	—	—	—
	Phenyl Hydrazine	—	—	—	○	—	—	—	—	—	X	△	○
	Phorone	—	—	—	○	—	—	—	—	—	X	—	—
	Phosphoric Acid (50%, 20°C)	X	△	○	○	X	△	△	△	○	X	—	—
	Phosphoric Acid (50%, 70°C)	X	X	○	○	X	△	X	△	○	X	—	—
	Phosphoric Acid (75%, 20°C)	X	X	○	○	X	△	△	△	○	X	—	—
	Phosphorobenzene	△	○	○	—	△	—	△	—	—	—	—	—
	Pickling Solution (Nitric Acid 20%/Fluoric Acid 4%)	—	X	○	○	—	—	—	△	○	X	—	—
	Pickling Solution (Sulfuric Acid 40%/Nitric Acid 15%)	—	X	○	○	—	—	—	△	○	△	—	—
	Picric Acid	X	X	△	○	X	△	△	△	△	△	○	○
	Pine Oil	—	X	X	○	△	△	○	△	△	○	—	—
	Pinene	—	○	X	○	—	—	—	—	—	○	—	—
	Piperidine	—	△	△	○	—	—	—	—	—	X	X	X
	Potassium Bichromate	△	△	○	○	X	—	△	△	○	△	○	△
	Potassium Chloride	○	○	○	○	△	△	○	△	○	○	○	○
	Potassium Cyanide	—	○	○	○	X	△	△	—	○	○	—	—
	Potassium Hydroxide	△	△	○	○	△	△	△	X	○	○	○	X
	Potassium Nitrate	○	△	○	○	△	△	△	△	○	○	○	○
	Potassium Permanganate (5%, 20°C)	X	X	△	○	△	△	△	△	○	X	○	X
	Potassium Sulfate	○	○	○	○	△	△	△	△	○	○	○	○
	Propane	△	○	○	○	○	○	○	○	○	○	X	○
	Propyl Acetate	X	○	X	○	○	—	○	△	X	X	△	X
	Propyl Alcohol	X	△	△	○	△	○	○	△	△	△	○	○
	Propylene	—	○	—	○	○	○	○	○	—	△	X	○
	Pyridine	△	X	○	○	△	—	△	△	—	X	—	X
	Pyrrole	—	—	△	○	—	—	—	—	—	X	X	X
S	Salicylic Acid	—	—	○	○	○	△	△	△	○	△	○	○
	Salt Water	—	○	○	○	X	△	△	△	○	○	—	○
	Sea Water	○	○	○	○	△	○	○	△	—	○	○	○
	Silicone Grease	—	○	△	○	—	—	—	○	△	○	○	○
	Silicone Oil	—	○	△	○	—	—	—	○	△	○	○	○
	Silver Nitrate	—	△	○	○	—	—	—	△	○	△	○	○
	Soap Aqueous Solution	○	○	△	○	○	○	○	△	○	○	○	○
	Soda Water	○	○	○	○	—	—	—	△	—	—	—	—
	Sodium Bicarbonate	○	○	○	○	X	—	△	△	○	○	—	○
	Sodium Bisulphate	○	○	○	○	—	—	—	△	○	○	—	—
	Sodium Carbonate	○	○	○	○	○	△	△	△	—	○	○	○
	Sodium Cyanide	○	○	○	○	X	—	△	△	○	○	○	—
	Sodium Hydroxide (10%, 20°C)	X	○	○	○	△	△	△	△	○	○	○	—
	Sodium Hydroxide (30%, 20°C)	X	○	○	○	—	—	—	X	○	○	○	X
	Sodium Hydroxide (30%, 70°C)	X	X	X	○	—	—	—	X	○	○	○	X
	Sodium Hypochlorite (5%, 20°C)	X	X	○	○	X	X	△	△	○	X	○	○
	Sodium Hypochlorite (5%, 70°C)	X	X	△	○	X	X	△	△	○	X	△	○
	Sodium Metaphosphate	—	○	○	○	—	—	△	△	○	○	○	○
	Sodium Nitrate	○	○	○	○	△	○	○	△	○	○	—	—
	Sodium Perborate	—	○	○	○	X	—	△	△	○	△	○	○
	Sodium Peroxide	—	X	○	X	X	—	△	—	○	△	○	○
	Sodium Phosphate	○	○	○	○	—	△	△	△	○	○	—	—
	Sodium Silicate	○	○	○	○	△	—	△	△	—	○	○	○
	Sodium Sulfate	○	○	○	○	○	△	△	△	○	○	○	○
	Sodium Sulfide	○	○	○	—	X	△	△	△	—	○	○	○
	Sodium Sulfite	—	X	X	○	○	○	○	△	—	○	—	—
	Sodium Thiosulfate	○	○	○	○	△	—	△	△	○	△	○	○
	Soy Bean Oil	—	○	○	○	△	△	○	○	○	○	—	—
	Stannic Chloride	—	△	○	○	X	X	X	△	○	○	○	○
	Stannous Chloride	○	△	○	—	X	X	X	△	—	○	○	○
	Stearic Acid	○	○	○	○	△	△	△	△	○	△	△	—
	Styrene	△	△	△	○	△	—	△	△	△	X	X	○
	Sulfur	○	○	○	○	X	△	△	—	○	X	○	○

Tubing
Clean tubing
Processed tubing
PushOne fitting
QuickSeal fitting
Clean fitting/Chemifit
Bamboo-shoot fitting
Control switch/Detachable series
Jig/Tool/Accessory
Technical information
Reference

Chemical Resistance Specification Table (for reference)

Test is conducted for saturated solutions of chemicals in the table at room temperature unless specifically indicated.

	Chemical (weight concentration %, temperature °C)	Tubing material				Fitting material				Seal material			
		Polyurethane	Nylon	Polyolefin	Fluorocarbon resin	Brass	SUS304	SUS316	PBT	PP	NBR	EPDM	FKM
S	Sulfur Chloride	—	—	×	○	×	—	△	—	○	△	×	○
	Sulfur Dioxide	×	×	×	○	—	—	△	△	—	△	—	—
	Sulfur Trioxide	×	△	○	○	△	△	△	△	—	—	—	—
	Sulfuric Acid (10%, 20°C)	×	△	△	○	×	×	×	△	○	×	○	○
	Sulfuric Acid (10%, 70°C)	×	×	△	○	×	×	×	×	○	×	○	○
	Sulfuric Acid (30%, 20°C)	×	×	△	○	×	×	×	△	○	×	○	○
	Sulfuric Acid (30%, 70°C)	×	×	×	○	×	×	×	×	○	×	○	○
	Sulfuric Acid (98%, 20°C)	×	×	×	○	×	×	×	×	×	×	×	○
	Sulfuric Acid (fuming, 20°C)	×	×	×	○	×	×	×	×	×	×	×	○
T	Sulfurous Acid	×	×	×	○	×	△	△	△	—	△	△	○
	Table Salt	○	○	○	○	△	△	△	△	○	○	—	○
	Tannic Acid	△	○	○	○	×	△	△	—	○	○	○	○
	Tartaric Acid	○	△	○	○	×	△	△	△	○	○	—	—
	Terpineol	—	○	×	○	—	—	—	—	△	×	—	—
	Tetrachloroethane	—	△	×	○	—	—	—	×	×	×	×	○
	Tetraethyl Lead	—	△	△	○	△	—	△	—	—	—	—	—
	Tetrahydro Furan	—	△	×	○	—	—	—	×	×	×	△	×
	Tetralin	—	△	×	○	—	—	—	—	×	×	×	○
	Tetramethyl Lead	○	○	—	○	—	—	—	—	—	—	—	—
	Thionyl Chloride	—	×	×	○	—	—	—	—	×	—	—	○
	Toluene	×	△	×	△	○	○	○	△	×	×	×	△
	Triacetin	—	—	—	○	—	—	—	—	—	△	○	×
	Tributoxyethyl Phosphate	—	○	—	○	—	—	—	○	—	×	—	—
	Tributyl Phosphate	△	○	×	○	○	—	○	○	—	×	—	×
	Trichloroacetic Acid	×	×	△	—	—	△	△	△	—	—	—	—
	Trichloroethylene	×	△	×	○	○	—	○	△	×	×	×	○
	Tricresyl Phosphate	△	○	×	○	—	—	—	○	—	×	○	○
	Triethanolamine	—	○	×	○	—	—	○	△	△	△	△	×
	Tung Oil	—	○	○	○	○	○	○	—	○	○	×	○
	Turpentine Oil	○	○	×	○	△	—	○	△	×	△	△	○
U	Uric Acid	×	○	○	—	—	—	—	△	—	△	○	△
V	Vegetable Oil	—	○	○	○	—	—	—	△	○	○	△	○
X	Xylene	×	△	×	○	—	○	○	○	×	×	×	○
Z	Zeolite	—	○	○	○	—	—	—	△	○	○	○	○
	Zinc Acetate	—	○	○	○	—	—	—	△	○	—	—	—
	Zinc Chloride	○	△	○	○	×	△	○	△	○	○	○	○
	Zinc Sulfide	△	△	○	○	△	△	△	△	○	△	○	△

Product Number Index

	Product number	Model type	Shape	Page	
1	101	Q.D.C 101 Series		152	
	103	Q.D.C 103 Series		155	
	1213	Multi-pack Tubing		33	
	1300	Shape-keeping Tubing (DK tubing)		24	
3	330	Chemifit CSE Series	Socket	124	
	3A0	Chemifit CSE Series	Bushing	124	
4	4A01	QuickSeal Series Insertless Type	Connector	95	
	4A02	QuickSeal Series Insertless Type	90 degree elbow	95	
	4A03	QuickSeal Series Insertless Type	Tee	95	
	4A04	QuickSeal Series Insertless Type	Service tee	96	
	4A05	QuickSeal Series Insertless Type	Union tee	96	
	4A06	QuickSeal Series Insertless Type	Swivel nut internal connector	96	
	4A07	QuickSeal Series Insertless Type	Union connector	97	
	4A08	QuickSeal Series Insertless Type	90 degree union elbow	97	
	A	A45L	PushOne A Series	45 degree elbow	40
AAL		PushOne A Series	Adapter elbow	47	
AC		PushOne A Series	Connector	38	
AC*-★A		PushOne A Series	Hexagon socket connector	38	
AC*-★A-M		PushOne A Series Mini Type	Hexagon socket connector	52	
AC*-M		PushOne A Series Mini Type	Connector	52	
ACC		PushOne A Series	Tubing cap	49	
AFC		PushOne A Series	Internal connector	38	
AFL		PushOne A Series	90 degree internal elbow	39	
AL		PushOne A Series	90 degree elbow	39	
AL*-M		PushOne A Series Mini Type	90 degree elbow	52	
ALB		PushOne A Series	Universal elbow	41	
ALL		PushOne A Series	90 degree long elbow	40	
ALL*-M		PushOne A Series Mini Type	90 degree long elbow	53	
ALTB		PushOne A Series	Triple universal elbow	42	
ALWB		PushOne A Series	Double universal elbow	42	
ALY		PushOne A Series	90 degree branch elbow	41	
ALYB		PushOne A Series	Universal branch elbow	42	
AMA		PushOne A Series	Manifold A type	48	
AMB		PushOne A Series	Manifold B type	48	
ANC		Throttle Valve	Elbow type	147	
ANU		Throttle Valve	Inline type	147	
APC		PushOne A Series	Panel touch connector	46	
APFC		PushOne A Series	Internal panel touch connector	46	
APL		PushOne A Series	90 degree panel touch elbow	47	
AR		PushOne A Series	Reducer	47	
ASC		Compact Speed Controller	Elbow type	139	
ASD		Compact Speed Controller	Universal type	139	
AST		PushOne A Series	Service tee	43	
AST*-M		PushOne A Series Mini Type	Service tee	53	
ASU		Speed Controller	Inline type	141	
AT		PushOne A Series	Tee	43	
AT*-M		PushOne A Series Mini Type	Tee	53	
AUC		PushOne A Series	Union connector	44	
AUC*-M		PushOne A Series Mini Type	Union connector	54	
AUL		PushOne A Series	90 degree union elbow	44	
AUL*-M		PushOne A Series Mini Type	90 degree union elbow	54	
AULY		PushOne A Series	90 degree branch union elbow	45	
AUT		PushOne A Series	Union tee	45	
AUT*-M		PushOne A Series Mini Type	Union tee	55	
AUWY		PushOne A Series	Double Y union	46	
AY		PushOne A Series	Y joint	44	
AY*-M		PushOne A Series Mini Type	Y joint	54	
AYA		PushOne A Series	Y plug	48	
AYB		PushOne A Series	Y union	45	
AYB*-M		PushOne A Series Mini Type	Y union	55	
B		BAB	Bamboo-shoot Series Barb Type	Adapter bush	133
		BAN	Bamboo-shoot Series Barb Type	Adapter nipple	133
		BBP	Bamboo-shoot Series Barb Type	Plug	133
		BC	PushOne A Series	Blank plug	49
		BC	PushOne A Series Mini Type	Blank plug	55
		BC	PushOne E Series	Blank plug	71
		BC	PushOne E Series Brass Body Type	Blank plug	75
	BC*-C1	Chemifit C1 Series	Blank plug	111	
	BL	Bamboo-shoot Series Barb Type	Elbow block	133	
	BN	Bamboo-shoot Series Barb Type	Connector	133	
	BRK	Speed Controller	Bracket	141	

Tubing

Clean tubing

Processed tubing

PushOne fitting

QuickSeal fitting

Clean fitting/Chemifit

Bamboo-shoot fitting

Control switch/Detachable series

Jig/Tool/Accessory

Technical information

Reference

	Product number	Model type	Shape	Page
B	BRK	Throttle Valve	Bracket	147
	BT	Bamboo-shoot Series Barb Type	Tee block	133
	BUVL	Bamboo-shoot Series Barb Type	Universal elbow block	133
	BUVT	Bamboo-shoot Series Barb Type	Universal tee block	133
C	C1N	QuickSeal Series Insertion Type (brass)	Connector (group 1)	78
	C1N★-S	QuickSeal Series Insertion Type (stainless)	Connector (group 1)	90
	C2N	QuickSeal Series Insertion Type (brass)	Connector (group 2)	78
	C4N	QuickSeal Series Insertion Type (brass)	Connector (group 4)	78
	C4N★-S	QuickSeal Series Insertion Type (stainless)	Connector (group 4)	90
	CP	Spatter Cap		161
	CP-C★	Chemifit CP Series	Connector	128
	CPFW	Spatter Cap		161
	CPI	Chemifit CP Series	Insertion part	131
	CP-L★	Chemifit CP Series	90 degree elbow	128
	CPN	Chemifit CP Series	Nut	131
	CPP	Spatter Cap		161
	CPS	Chemifit CP Series	Sleeve	131
	CP-ST★	Chemifit CP Series	Service tee	129
	CP-T★	Chemifit CP Series	Tee	129
	CP-UC★	Chemifit CP Series	Union connector	130
	CP-UL★	Chemifit CP Series	90 degree union elbow	130
	CP-UT★	Chemifit CP Series	Union tee	130
	CSAN	Chemifit CSE Series	Assembly nut	123
	CSE-C★	Chemifit CSE Series	Connector	120
	CSE-FC★	Chemifit CSE Series	Internal connector	120
	CSE-L★	Chemifit CSE Series	90 degree elbow	121
	CSE-ST★	Chemifit CSE Series	Service tee	122
	CSE-T★	Chemifit CSE Series	Tee	121
	CSE-UC★	Chemifit CSE Series	Union connector	122
	CSE-UCT★	Chemifit CSE Series	Panel touch connector	123
	CSE-UL★	Chemifit CSE Series	90 degree union elbow	122
CSE-UT★	Chemifit CSE Series	Union tee	123	
D	DC	QuickSeal Series DK Tubing Dedicated Type	Connector	99
	DL	QuickSeal Series DK Tubing Dedicated Type	90 degree elbow	99
	DT	QuickSeal Series DK Tubing Dedicated Type	Tee	99
	DUP	QuickSeal Series DK Tubing Dedicated Type	Panel touch connector for copper pipe	101
	DUT	QuickSeal Series DK Tubing Dedicated Type	Panel touch connector	100
E	E45L	PushOne E Series	45 degree elbow	61
	EAL	PushOne E Series	Adapter elbow	69
	EC	PushOne E Series	Connector	58
	EC★-★A	PushOne E Series	Hexagonal socket connector	58
	EC★-C1	Chemifit C1 Series	Connector	106
	EC★-C1S	Chemifit C1S Series	Connector	114
	ECC	PushOne E Series	Tubing cap	71
	ECV	Valve Built-in Connector		151
	EFC	PushOne E Series	Internal connector	59
	EFL	PushOne E Series	90 degree internal elbow	60
	EFC★-C1S	Chemifit C1S Series	Internal connector	114
	EL	PushOne E Series	90 degree elbow	59
	EL★-C1	Chemifit C1 Series	90 degree elbow	107
	EL★-C1S	Chemifit C1S Series	90 degree elbow	114
	ELB	PushOne E Series	Universal elbow	61
	ELL	PushOne E Series	90 degree long elbow	60
	ELTB	PushOne E Series	Triple universal elbow	63
	ELWB	PushOne E Series	Double universal elbow	62
	ELY	PushOne E Series	90 degree branch elbow	62
	ELYB	PushOne E Series	Universal branch elbow	62
EMA	PushOne E Series	Manifold A type	70	
EMA★-C1	Chemifit C1 Series	Manifold	111	
EMB	PushOne E Series	Manifold B type	70	
EMVA	Miniature Valve (PushOne)	Inline type	149	
EMVB	Miniature Valve (PushOne)	Straight type	149	
EMVC	Miniature Valve (PushOne)	Angled type	149	
EN	PushOne A Series	Nipple	49	
EN	PushOne A Series Mini Type	Nipple	55	
EN	PushOne E Series	Nipple	71	
EN	PushOne E Series Brass body Type	Nipple	75	
EOT	Off Tool		161	
EPC	PushOne E Series	Panel touch connector	68	
EPC★-C1	Chemifit C1 Series	Panel touch connector	110	
EPC★-C1S	Chemifit C1S Series	Panel touch connector	116	

	Product number	Model type	Shape	Page
E	EPFC	PushOne E Series	Internal panel touch connector	68
	EPL	PushOne E Series	90 degree panel touch elbow	69
	ER	PushOne E Series	Reducer	69
	ER*-C1	Chemifit C1 Series	Reducer	111
	ES	Clean, Antistatic Tubing		25
	ESC*-C1SG	Chemifit C1 Speed Controller	Elbow type	137
	EST	PushOne E Series	Service tee	64
	EST*-C1	Chemifit C1 Series	Service tee	108
	EST*-C1S	Chemifit C1S Series	Service tee	115
	ESU*-C1SG	Chemifit C1 Speed Controller	Inline type	137
	ET	PushOne E Series	Tee	63
	ET*-C1	Chemifit C1 Series	Tee	107
	ET*-C1S	Chemifit C1S Series	Tee	115
	ETC*-C1	Chemifit C1 Series	Through connector	106
	EUC	PushOne E Series	Union connector	65
	EUC*-C1	Chemifit C1 Series	Union connector	109
	EUL	PushOne E Series	90 degree union elbow	66
	EUL*-C1	Chemifit C1 Series	90 degree union elbow	109
	EULY	PushOne E Series	90 degree branch union elbow	66
	EUT	PushOne E Series	Union tee	67
	EUT*-C1	Chemifit C1 Series	Union tee	110
EUWY	PushOne E Series	Double Y union	68	
EY	PushOne E Series	Y joint	65	
EY*-C1	Chemifit C1 Series	Y joint	108	
EY*-C1S	Chemifit C1S Series	Y joint	116	
EYA	PushOne E Series	Y plug	70	
EYB	PushOne E Series	Y union	67	
EYB*-C1	Chemifit C1 Series	Y union	110	
F	FC1N	QuickSeal Series Insertion Type (brass)	Internal connector (group 1)	82
	FC4N	QuickSeal Series Insertion Type (brass)	Internal connector (group 4)	82
	FS	Flame-resistant Tubing		20
	FUK	Flame-resistant Tubing		19
	FW	Flame-resistant Tubing		21
	FWU	Flame-resistant Tubing		22
H	HC03	Hose Cutter		159
	HPN	Speed Controller	Connector pin	141
	HPN	Throttle Valve	Connector pin	147
	HPN*-C1	Chemifit C1 Speed Controller	Connector pin	137
L	L1N	QuickSeal Series Insertion Type (brass)	90 degree elbow (group 1)	79
	L1N*-S	QuickSeal Series Insertion Type (stainless)	90 degree elbow (group 1)	90
	L2N	QuickSeal Series Insertion Type (brass)	90 degree elbow (group 2)	79
	L4N	QuickSeal Series Insertion Type (brass)	90 degree elbow (group 4)	79
	L4N*-S	QuickSeal Series Insertion Type (stainless)	90 degree elbow (group 4)	90
M	MEL	PushOne E Series Brass Body Type	90 degree elbow	74
	MEST	PushOne E Series Brass Body Type	Service tee	74
	MET	PushOne E Series Brass Body Type	Tee	74
	MEUC	PushOne E Series Brass Body Type	Union connector	75
	MEUL	PushOne E Series Brass Body Type	90 degree union elbow	75
	MEUT	PushOne E Series Brass Body Type	Union tee	75
	MRG	Bamboo-shoot Series Barb Type	Gasket	133
	MSN	QuickSeal Series Insertion Type (brass)	Brass sleeve	85
	MSN	QuickSeal Series Insertless Type	Brass sleeve	97
	N	N	QuickSeal Series Insertion Type (brass)	Brass nut
N		QuickSeal Series Insertless Type	Brass nut	97
N		QuickSeal Series DK Tubing Dedicated Type	Brass nut	101
N*-S		QuickSeal Series Insertion Type (stainless)	Stainless nut	93
N1		Nylon Tubing		17
N2		Nylon Tubing		15
N5		Nylon Tubing		16
P		PB	Polybutene Tubing	
	PL	Polyolefin Resin Tubing		26
	PN	Polyolefin Resin Tubing		27
	PTR	Tube Reel		161
Q	QMVA	Miniature Valve (QuickSeal)	Inline type	150
	QMVB	Miniature Valve (QuickSeal)	Straight type	150
	QMVC	Miniature Valve (QuickSeal)	Angled type	150
S	S	Nylon Coil Tubing		32
	S*-ES*	QuickSeal Series Nylon Coil tubing Dedicated Type	ES swivel nut internal connector	103
	S*-FS*	QuickSeal Series Nylon Coil tubing Dedicated Type	FS swivel nut internal connector	103
	S*-M*	QuickSeal Series Nylon Coil tubing Dedicated Type	Connector	102
	S101	Q.D.C. 101 Series (SUS304)		152

	Product number	Model type	Shape	Page	
S	SBRK	Chemifit C1 Speed Controller	Bracket	137	
	SC1N	QuickSeal Series Insertion Type (brass)	Swivel nut internal connector (group 1)	84	
	SC2N	QuickSeal Series Insertion Type (brass)	Swivel nut internal connector (group 2)	84	
	SC4N	QuickSeal Series Insertion Type (brass)	Swivel nut internal connector (group 4)	84	
	SI	QuickSeal Series Nylon Coil Tubing Dedicated Type	Insertion part for S 3/4	103	
	SN	QuickSeal Series DK Tubing Dedicated Type	Nylon sleeve	101	
	SN	QuickSeal Series Insertion Type (brass)	Nylon sleeve	85	
	SN	QuickSeal Series Insertion Type (stainless)	Nylon sleeve	93	
	SS	QuickSeal Series Nylon Coil Tubing Dedicated Type	Nylon sleeve / Brass sleeve	103	
	ST1N	QuickSeal Series Insertion Type (brass)	Service tee (group 1)	81	
	ST1N★-S	QuickSeal Series Insertion Type (stainless)	Service tee (group 1)	91	
	ST2N	QuickSeal Series Insertion Type (brass)	Service tee (group 2)	81	
	ST4N	QuickSeal Series Insertion Type (brass)	Service tee (group 4)	81	
	ST4N★-S	QuickSeal Series Insertion Type (stainless)	Service tee (group 4)	91	
	T	T1N	QuickSeal Series Insertion Type (brass)	Tee (group 1)	80
		T1N★-S	QuickSeal Series Insertion Type (stainless)	Tee (group 1)	91
		T2N	QuickSeal Series Insertion Type (brass)	Tee (group 2)	80
T4N		QuickSeal Series Insertion Type (brass)	Tee (group 4)	80	
T4N★-S		QuickSeal Series Insertion Type (stainless)	Tee (group 4)	91	
TA		Fluorocarbon Resin Tubing		28	
TC01		Tube Cutter		159	
TC02		FW Tubing Outer Cover Peeling Cutter		160	
TC02U		FWU Tubing Outer Cover Peeling Cutter		160	
TC03		FW Tubing Outer Cover Peeling Cutter		160	
TC03U		FWU Tubing Outer Cover Peeling Cutter		160	
TC04		Tube Cutter		159	
TES		Flexible Fluorocarbon Resin Tubing		18	
TP		Fluorocarbon Resin Tubing		29	
U		U1	Polyurethane Tubing		13
		U2	Polyurethane Tubing		12
		U5	Polyurethane Tubing		14
	UC	Polyurethane Coil Tubing		30	
	UC1N	QuickSeal Series Insertion Type (brass)	Union connector (group 1)	82	
	UC1N★-S	QuickSeal Series Insertion Type (stainless)	Union connector (group 1)	92	
	UC4N	QuickSeal Series Insertion Type (brass)	Union connector (group 4)	82	
	UC4N★-S	QuickSeal Series Insertion Type (stainless)	Union connector (group 4)	92	
	UCT1N	QuickSeal Series Insertion Type (brass)	Panel touch connector (group 1)	84	
	UCT4N	QuickSeal Series Insertion Type (brass)	Panel touch connector (group 4)	84	
	UDC	QuickSeal Series DK Tubing Dedicated Type	Union connector	100	
	UDT	QuickSeal Series DK Tubing Dedicated Type	Union tee	100	
	UE	Anti static Tubing		23	
	UL1N	QuickSeal Series Insertion Type (brass)	90 degree union elbow (group 1)	83	
	UL4N	QuickSeal Series Insertion Type (brass)	90 degree union elbow (group 4)	83	
	UL4N★-S	QuickSeal Series Insertion Type (stainless)	90 degree union elbow (group 4)	92	
	V	UMC	Polyurethane Coil Tubing		30
UML		Polyurethane Multi-line Tubing		31	
USC		Polyurethane Coil Tubing		30	
UT1N		QuickSeal Series Insertion Type (brass)	Union tee (group 1)	83	
UT1N★-S		QuickSeal Series Insertion Type (stainless)	Union tee (group 1)	92	
UT2N		QuickSeal Series Insertion Type (brass)	Union tee (group 2)	83	
UT4N		QuickSeal Series Insertion Type (brass)	Union tee (group 4)	83	
UT4N★-S		QuickSeal Series Insertion Type (stainless)	Union tee (group 4)	92	
VA		Ball Valve	Angled type	145	
VS		Ball Valve	Straight type	144	

NITTA CORPORATION

<https://www.nitta.co.jp/en>



4-4-26 Sakuragawa Naniwa-ku, Osaka 556-0022 JAPAN Phone:+81-6-6563-1241 Fax:+81-6-6563-1243

NITTA CORPORATION OF AMERICA

7605 Nitta Drive, Suwanee, GA 30024, U.S.A.
Phone:+1-770-497-0212 Fax:+1-770-623-1398
<https://www.nitta.com>

NITTA (SHANGHAI) MANAGEMENT CO., LTD.

Room 2705, Shenggao International Building, No.137 Xianxia Road, Shanghai 200051, P.R.CHINA
Phone:+86-21-6229-6000 Fax:+86-21-6229-9606
<http://www.nitta.com.cn/index.php?s=/>

TAIWAN NITTA FILTER CO.,LTD.

Chia Hsin Building, 10FL, Room No. 1005, 96 Chung Shan North Road Section 2, Taipei, TAIWAN
Phone:+886-2-2581-6296 Fax:+886-2-2563-4900
<https://www.nitta.com.tw>

NITTA INDUSTRIES EUROPE GmbH

Heerdter Lohweg 35, 40549 Dusseldorf, GERMANY
Phone:+49-211-537535-0 Fax:+49-211-537535-35
<https://www.nitta.de>

NITTA CORPORATION (THAILAND) LIMITED

7/472 Moo 6, Tambol Mabyangporn, Amphur Pluudaeng, Rayong Province 21140, THAILAND
Phone:+66-38-018-301 Fax:+66-38-018-304
<https://www.nittathai.com>

NITTA CORPORATION INDIA PVT. LTD.

Gat No.191, 192, and 193, Plot No B, Village Vadhu Khurd, Taluka Haveli Dist Pune-412216, INDIA
Phone:+91-20-6731-3400 Fax:+91-20-6731-3401
<https://www.nitta.co.in>